

**RF Toolbox™**

**User's Guide**

**R2012b**

**MATLAB®**

## How to Contact MathWorks



[www.mathworks.com](http://www.mathworks.com) Web  
[comp.soft-sys.matlab](mailto:comp.soft-sys.matlab) Newsgroup  
[www.mathworks.com/contact\\_TS.html](http://www.mathworks.com/contact_TS.html) Technical Support



[suggest@mathworks.com](mailto:suggest@mathworks.com) Product enhancement suggestions  
[bugs@mathworks.com](mailto:bugs@mathworks.com) Bug reports  
[doc@mathworks.com](mailto:doc@mathworks.com) Documentation error reports  
[service@mathworks.com](mailto:service@mathworks.com) Order status, license renewals, passcodes  
[info@mathworks.com](mailto:info@mathworks.com) Sales, pricing, and general information



508-647-7000 (Phone)



508-647-7001 (Fax)



The MathWorks, Inc.  
3 Apple Hill Drive  
Natick, MA 01760-2098

For contact information about worldwide offices, see the MathWorks Web site.

*RF Toolbox™ User's Guide*

© COPYRIGHT 2004–2012 by The MathWorks, Inc.

The software described in this document is furnished under a license agreement. The software may be used or copied only under the terms of the license agreement. No part of this manual may be photocopied or reproduced in any form without prior written consent from The MathWorks, Inc.

FEDERAL ACQUISITION: This provision applies to all acquisitions of the Program and Documentation by, for, or through the federal government of the United States. By accepting delivery of the Program or Documentation, the government hereby agrees that this software or documentation qualifies as commercial computer software or commercial computer software documentation as such terms are used or defined in FAR 12.212, DFARS Part 227.72, and DFARS 252.227-7014. Accordingly, the terms and conditions of this Agreement and only those rights specified in this Agreement, shall pertain to and govern the use, modification, reproduction, release, performance, display, and disclosure of the Program and Documentation by the federal government (or other entity acquiring for or through the federal government) and shall supersede any conflicting contractual terms or conditions. If this License fails to meet the government's needs or is inconsistent in any respect with federal procurement law, the government agrees to return the Program and Documentation, unused, to The MathWorks, Inc.

### Trademarks

MATLAB and Simulink are registered trademarks of The MathWorks, Inc. See [www.mathworks.com/trademarks](http://www.mathworks.com/trademarks) for a list of additional trademarks. Other product or brand names may be trademarks or registered trademarks of their respective holders.

### Patents

MathWorks products are protected by one or more U.S. patents. Please see [www.mathworks.com/patents](http://www.mathworks.com/patents) for more information.

## Revision History

June 2004	Online only	New for Version 1.0 (Release 14)
August 2004	Online only	Revised for Version 1.0.1 (Release 14+)
March 2005	Online only	Revised for Version 1.1 (Release 14SP2)
September 2005	Online only	Revised for Version 1.2 (Release 14SP3)
March 2006	Online only	Revised for Version 1.3 (Release 2006a)
September 2006	Online only	Revised for Version 2.0 (Release 2006b)
March 2007	Online only	Revised for Version 2.1 (Release 2007a)
September 2007	Online only	Revised for Version 2.2 (Release 2007b)
March 2008	Online only	Revised for Version 2.3 (Release 2008a)
October 2008	Online only	Revised for Version 2.4 (Release 2008b)
March 2009	Online only	Revised for Version 2.5 (Release 2009a)
September 2009	Online only	Revised for Version 2.6 (Release 2009b)
March 2010	Online only	Revised for Version 2.7 (Release 2010a)
September 2010	Online only	Revised for Version 2.8 (Release 2010b)
April 2011	Online only	Revised for Version 2.8.1 (Release 2011a)
September 2011	Online only	Revised for Version 2.9 (Release 2011b)
March 2012	Online only	Revised for Version 2.10 (Release 2012a)
September 2012	Online only	Revised for Version 2.11 (Release 2012b)



## Getting Started

**1**

<b>Product Description</b> .....	<b>1-2</b>
Key Features .....	1-2
<b>Related Products</b> .....	<b>1-3</b>
<b>RF Objects</b> .....	<b>1-4</b>
<b>S-Parameter Notation</b> .....	<b>1-6</b>
Define S-Parameters .....	1-6
Refer to S-Parameters Using Strings .....	1-7
<b>RF Analysis</b> .....	<b>1-9</b>
<b>Model a Cascaded RF Network</b> .....	<b>1-11</b>
Overview .....	1-11
Create RF Components .....	1-11
Specify Component Data .....	1-12
Validate RF Components .....	1-12
Build and Simulate the Network .....	1-14
Analyze Simulation Results .....	1-15
<b>Analyze a Transmission Line</b> .....	<b>1-19</b>
Overview .....	1-19
Build and Simulate the Transmission Line .....	1-19
Compute the Transmission Line Transfer Function and Time-Domain Response .....	1-19
Export a Verilog-A Model .....	1-24

**2**

<b>RF Data Objects</b> .....	2-2
Overview .....	2-2
Types of Data .....	2-2
Available Data Objects .....	2-2
Data Object Methods .....	2-3
<b>RF Circuit Objects</b> .....	2-4
Overview of RF Circuit Objects .....	2-4
Components Versus Networks .....	2-4
Available Components and Networks .....	2-5
Circuit Object Methods .....	2-7
<b>RF Model Objects</b> .....	2-10
Overview of RF Model Objects .....	2-10
Available Model Objects .....	2-10
Model Object Methods .....	2-10
<b>RF Network Parameter Objects</b> .....	2-12
Overview of Network Parameter Objects .....	2-12
Available Network Parameter Objects .....	2-12
Network Parameter Object Functions .....	2-13

**Model an RF Component**

**3**

<b>Create RF Objects</b> .....	3-2
Construct a New Object .....	3-2
Copy an Existing Object .....	3-4
<b>Specify or Import Component Data</b> .....	3-5
RF Object Properties .....	3-5
Set Property Values .....	3-5
Import Property Values from Data Files .....	3-8
Use Data Objects to Specify Circuit Properties .....	3-11
Retrieve Property Values .....	3-14

Reference Properties Directly Using Dot Notation .....	3-16
<b>Specify Operating Conditions</b> .....	3-17
Available Operating Conditions .....	3-17
Set Operating Conditions .....	3-17
Display Available Operating Condition Values .....	3-18
<b>Process File Data for Analysis</b> .....	3-19
Convert Single-Ended S-Parameters to Mixed-Mode	
S-Parameters .....	3-19
Extract M-Port S-Parameters from N-Port	
S-Parameters .....	3-21
Cascade N-Port S-Parameters .....	3-23
<b>Analyze and Plot RF Components</b> .....	3-25
Analyze Networks in the Frequency Domain .....	3-25
Visualize Component and Network Data .....	3-26
Compute and Plot Time-Domain Specifications .....	3-35
<b>Export Component Data to a File</b> .....	3-38
Available Export Formats .....	3-38
How to Export Object Data .....	3-38
Export Object Data .....	3-39
<b>Basic Operations with RF Objects</b> .....	3-41
Read and Analyze RF Data from a Touchstone Data File ..	3-41
De-Embed S-Parameters .....	3-43

## Export Verilog-A Models

# 4

<b>Model RF Objects Using Verilog-A</b> .....	4-2
Overview .....	4-2
Behavioral Modeling Using Verilog-A .....	4-2
Supported Verilog-A Models .....	4-3
<b>Export a Verilog-A Model</b> .....	4-5
Represent a Circuit Object with a Model Object .....	4-5

## RF Tool: An RF Analysis GUI

# 5

<b>RF Tool</b> .....	5-2
What Is RF Tool? .....	5-2
Open RF Tool .....	5-2
RF Tool Window .....	5-3
RF Tool Workflow .....	5-5
<b>Create and Import Circuits with RF Tool</b> .....	5-6
Circuits in RF Tool .....	5-6
Create RF Components .....	5-6
Create RF Networks with RF Tool .....	5-10
Import RF Objects into RF Tool .....	5-15
<b>Modify Component Data in RF Tool</b> .....	5-19
<b>Analyze Circuits Using RF Tool</b> .....	5-20
<b>Export RF Objects from RF Tool</b> .....	5-23
Export Components and Networks .....	5-23
Export to the Workspace .....	5-23
Export to a File .....	5-25
<b>Manage Circuits and Sessions in RF Tool</b> .....	5-27
Working with Circuits .....	5-27
Working with RF Tool Sessions .....	5-28
<b>Model an RF Network Using RF Tool</b> .....	5-31
Overview .....	5-31
Start RF Tool .....	5-31
Create the Amplifier Network .....	5-31
Populate the Amplifier Network .....	5-34
Analyze the Amplifier Network .....	5-38
Export the Network to the Workspace .....	5-39



## Object Reference

---

# 6

<b>Analysis Objects</b> .....	<b>6-2</b>
<b>Circuit Objects</b> .....	<b>6-3</b>
Components .....	<b>6-3</b>
Networks .....	<b>6-4</b>
<b>Data Objects</b> .....	<b>6-5</b>
<b>Model Objects</b> .....	<b>6-6</b>

## Objects — Alphabetical List

---

# 7

## Method Reference

---

# 8

<b>Analysis</b> .....	<b>8-2</b>
<b>Plots and Charts</b> .....	<b>8-3</b>
<b>Parameters and Formats</b> .....	<b>8-5</b>
<b>Operating Conditions</b> .....	<b>8-6</b>
<b>Data I/O</b> .....	<b>8-7</b>
<b>Data Access and Restoration</b> .....	<b>8-8</b>

## Methods — Alphabetical List

---

**9**

### Function Reference

---

**10**

Calculations .....	10-2
Data Visualization .....	10-3
Utilities .....	10-4
Network Parameter Conversion .....	10-5
GUI .....	10-8

## Functions — Alphabetical List

---

**11**

### AMP File Format

---

**A**

AMP File Data Sections .....	A-2
Overview .....	A-2
Denoting Comments .....	A-3
Data Sections .....	A-3
S, Y, or Z Network Parameters .....	A-4
Noise Parameters .....	A-6
Noise Figure Data .....	A-7
Power Data .....	A-9
IP3 Data .....	A-12
Inconsistent Data Sections .....	A-13

## Examples

# B

Modeling a Cascaded RF Network .....	B-2
Modeling a Transmission Line .....	B-3
Working with Objects .....	B-4
Exporting Object Data .....	B-5
Modeling an RF Network Using RF Tool .....	B-6

## Index



# Getting Started

---

- “Product Description” on page 1-2
- “Related Products” on page 1-3
- “RF Objects” on page 1-4
- “S-Parameter Notation” on page 1-6
- “RF Analysis” on page 1-9
- “Model a Cascaded RF Network” on page 1-11
- “Analyze a Transmission Line” on page 1-19

## Product Description

### **Design, model, and analyze networks of RF components**

RF Toolbox™ extends the MATLAB® product with functions and a graphical user interface (GUI) for designing, modeling, analyzing, and visualizing networks of radio frequency (RF) components. You can use RF Toolbox software for working on wireless communications, radar, and signal integrity projects.

### **Key Features**

- Provides read and write access to industry-standard file formats for network parameters
- Defines RF filters, transmission lines, amplifiers, and mixers by their experimental or theoretical network parameters and physical properties
- Calculates network parameters for RF components in series, parallel, cascade, hybrid, and inverse hybrid configurations
- Builds models using the rational function fitting method
- Exports rational function models to Simulink® or as Verilog-A modules
- Calculates noise figures and third-order intercept points for cascaded components
- Converts among S, Y, Z, ABCD, h, g, and T network parameters
- Includes rectangular and polar plots and Smith® Charts for visualizing data

## Related Products

Several MathWorks® products are especially relevant to the kinds of tasks you can perform with RF Toolbox software. The following table summarizes the related products and describes how they complement the features of the toolbox.

<b>Product</b>	<b>Description</b>
“Communications System Toolbox™”	Simulink blocks and MATLAB functions for time-domain simulation of modulation and demodulation of a wireless communications signal.
“DSP System Toolbox™”	Simulink blocks and MATLAB functions for time-domain simulation of for filtering the modulated communication signal.
“SimRF™”	Circuit-envelope and equivalent-baseband simulation of RF components in Simulink.
“Signal Processing Toolbox™”	MATLAB functions for filtering the modulated communication signal.

## RF Objects

RF Toolbox software uses objects to represent RF components and networks. You create an object using the object's *constructor*. Every object has predefined fields called *properties*. The properties define the characteristics of the object. Each property associated with an object is assigned a value. Every object has a set of *methods*, which are operations that you can perform on the object. Methods are similar to functions except that they only act on an object.

The following table summarizes the types of objects that are available in the toolbox and describes the uses of each one. For more information on a particular type of object, including a list of the available objects and methods, follow the link in the table to the documentation for that object type.

Object Type	Name	Description
<a href="#">“RF Data Objects” on page 2-2</a>	<code>rfdata</code>	Stores data for use by other RF objects or for plotting and network parameter conversion.
<a href="#">“RF Circuit Objects” on page 2-4</a>	<code>rfckt</code>	Represents RF components and networks using network parameters and physical properties for frequency-domain simulation.
<a href="#">“RF Model Objects” on page 2-10</a>	<code>rfmodel</code>	Represents RF components and networks mathematically for computing time-domain behavior and exporting models.

Each name in the preceding table is the prefix to the names of all object constructors of that type. The constructors use *dot notation* that consists of the object type, followed by a dot and then the component name. The component name is also called the *class*. For information on how to construct an RF object from the command line using dot notation, see “Create RF Objects” on page 3-2.



You use a different form of dot notation to specify object properties, as described in “Reference Properties Directly Using Dot Notation” on page 3-16. This is just one way to define component data. For more information on object properties, see “Specify or Import Component Data” on page 3-5.

You use object methods to perform frequency-domain analysis and visualize the results. For more information, see “Analyze and Plot RF Components” on page 3-25.

---

**Note** The toolbox also provides a graphical interface for creating and analyzing circuit objects. For more information, see “RF Tool” on page 5-2.

---

## S-Parameter Notation

### In this section...

“Define S-Parameters” on page 1-6

“Refer to S-Parameters Using Strings” on page 1-7

### Define S-Parameters

RF Toolbox software uses matrix notation to specify S-parameters. The indices of an S-parameter matrix correspond to the port numbers of the network that the data represent. For example, to define a matrix of 50-ohm, 2-port S-parameters, type:

```
s11 = 0.61*exp(j*165/180*pi);  
s21 = 3.72*exp(j*59/180*pi);  
s12 = 0.05*exp(j*42/180*pi);  
s22 = 0.45*exp(j*(-48/180)*pi);  
s_params = [s11 s12; s21 s22];
```

RF Toolbox functions that operate on `s_params` assume:

- `s_params(1,1)` corresponds to the reflection coefficient at port 1,  $S_{11}$ .
- `s_params(2,1)` corresponds to the transmission coefficient from port 1 to port 2,  $S_{21}$ .
- `s_params(1,2)` corresponds to the transmission coefficient from port 2 to port 1,  $S_{12}$ .
- `s_params(2,2)` corresponds to the reflection coefficient at port 2,  $S_{22}$ .

RF Toolbox software also supports three-dimensional arrays of S-parameters. The third dimension of an S-parameter array corresponds to S-parameter data at different frequencies. The following figure illustrates this convention.

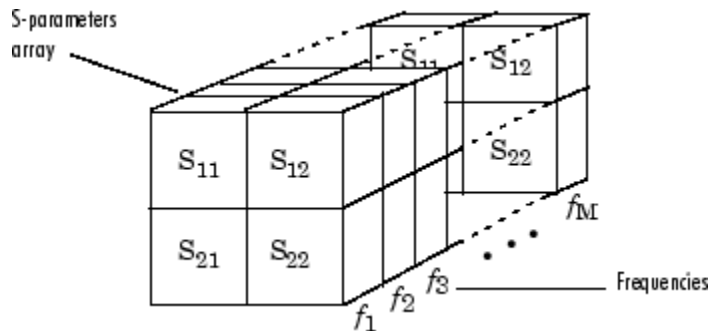

## Refer to S-Parameters Using Strings

RF Toolbox software uses strings to refer to S-parameters in plotting and calculation methods, such as `plot`. These strings have one of the following two forms:

- ' $S_{nm}$ ' — Use this syntax if  $n$  and  $m$  are both less than 10.
- ' $S_{n,m}$ ' — Use this syntax if one or both are greater than 10. ' $S_{n,m}$ ' is not a valid syntax when both  $n$  and  $m$  are less than 10.

The indices  $n$  and  $m$  are the port numbers for the S-parameters.

Most toolbox objects only analyze 2-port S-parameters. The following objects analyze S-parameters with more than two ports:

- `rfckt.passive`
- `rfckt.datafile`
- `rfdata.data`

You can get 2-port parameters from S-parameters with an arbitrary number of ports using one or more of the following steps:

- Extract 2-port S-parameters from N-port S-parameters.  
See “Extract M-Port S-Parameters from N-Port S-Parameters” on page 3-21.
- Convert single-ended 4-port parameters to differential 2-port parameters.

See “Convert Single-Ended S-Parameters to Mixed-Mode S-Parameters”  
on page 3-19.

## RF Analysis

When you analyze an RF circuit using RF Toolbox software, your workflow might include the following tasks:

- 1** Select RF circuit objects to represent the components of your RF network.

See “Create RF Objects” on page 3-2.

- 2** Define component data by:

- Specifying network parameters or physical properties (see “Set Property Values” on page 3-5).
- Importing data from an industry-standard Touchstone file, a MathWorks AMP file, an Agilent® P2D or S2D file, or the MATLAB workspace (see “Import Property Values from Data Files” on page 3-8).
- Where applicable, selecting operating condition values (see “Specify Operating Conditions” on page 3-17).

- 3** Where applicable, perform network parameter conversions on imported file data.

See “Process File Data for Analysis” on page 3-19.

- 4** Integrate components to form a cascade, hybrid, parallel, or series network.

See “Construct Networks of Specified Components” on page 3-7.

- 5** Analyze the network in the frequency domain.

See “Analyze Networks in the Frequency Domain” on page 3-25.

- 6** Generate plots to gain insight into network behavior.

The following plots and charts are available in the toolbox:

- Rectangular plots
- Polar plots
- Smith Charts
- Budget plots (for cascaded S-parameters)

See “Visualize Component and Network Data” on page 3-26.

**7** Compute the network transfer function.

See “Compute the Network Transfer Function” on page 3-35.

**8** Create an RF model object that describes the transfer function analytically.

See “Fit a Model Object to Circuit Object Data” on page 3-36.

**9** Plot the time-domain response.

See “Compute and Plotting the Time-Domain Response” on page 3-37.

**10** Export a Verilog-A description of the network.

See “Export a Verilog-A Model” on page 4-5.

# Model a Cascaded RF Network

## In this section...

“Overview” on page 1-11

“Create RF Components” on page 1-11

“Specify Component Data” on page 1-12

“Validate RF Components” on page 1-12

“Build and Simulate the Network” on page 1-14

“Analyze Simulation Results” on page 1-15

## Overview

In this example, you use the RF Toolbox command-line interface to model the gain and noise figure of a cascaded network. You analyze the network in the frequency domain and plot the results.

---

**Note** To learn how to use RF Tool to perform these tasks, see “Model an RF Network Using RF Tool” on page 5-31.

---

The network that you use in this example consists of an amplifier and two transmission lines. The toolbox represents RF components and RF networks using RF circuit objects. You learn how to create and manipulate these objects to analyze the cascaded amplifier network.

## Create RF Components

Type the following set of commands at the MATLAB prompt to create three circuit (`rfckt`) objects with the default property values. These circuit objects represent the two transmission lines and the amplifier:

```
FirstCkt = rfckt.txline;  
SecondCkt = rfckt.amplifier;  
ThirdCkt = rfckt.txline;
```

## Specify Component Data

In this part of the example, you specify the following component properties:

- “Transmission Line Properties” on page 1-12
- “Amplifier Properties” on page 1-12

### Transmission Line Properties

- 1 Type the following command at the MATLAB prompt to change the line length of the first transmission line, `FirstCkt`, to 0.001:

```
set(FirstCkt, 'LineLength', 0.001)
```

- 2 Type the following command at the MATLAB prompt to change the line length of the second transmission line, `ThirdCkt`, to 0.025 and to change the phase velocity to 2.0e8:

```
set(ThirdCkt, 'LineLength', 0.025, 'PV', 2.0e8)
```

### Amplifier Properties

- 1 Type the following command at the MATLAB prompt to import network parameters, noise data, and power data from the `default.amp` file into the amplifier, `SecondCkt`:

```
read(SecondCkt, 'default.amp');
```

- 2 Type the following command at the MATLAB prompt to change the interpolation method of the amplifier, `SecondCkt`, to cubic:

```
set(SecondCkt, 'IntpType', 'cubic')
```

The `IntpType` property tells the toolbox how to interpolate the network parameters, noise data, and power data when you analyze the amplifier at frequencies other than those specified in the file.

### Validate RF Components

In this part of the example, you plot the network parameters and power data (output power versus input power) to validate the behavior of the amplifier.



- 1 Type the following set of commands at the MATLAB prompt to use the smith command to plot the original  $S_{11}$  and  $S_{22}$  parameters of the amplifier (SecondCkt) on a Z Smith Chart:

```
figure
lineseries1 = smith(SecondCkt,'S11','S22');
set(lineseries1(1), 'LineStyle','-','LineWidth', 1);
set(lineseries1(2), 'LineStyle',':','LineWidth', 1);
legend show
```

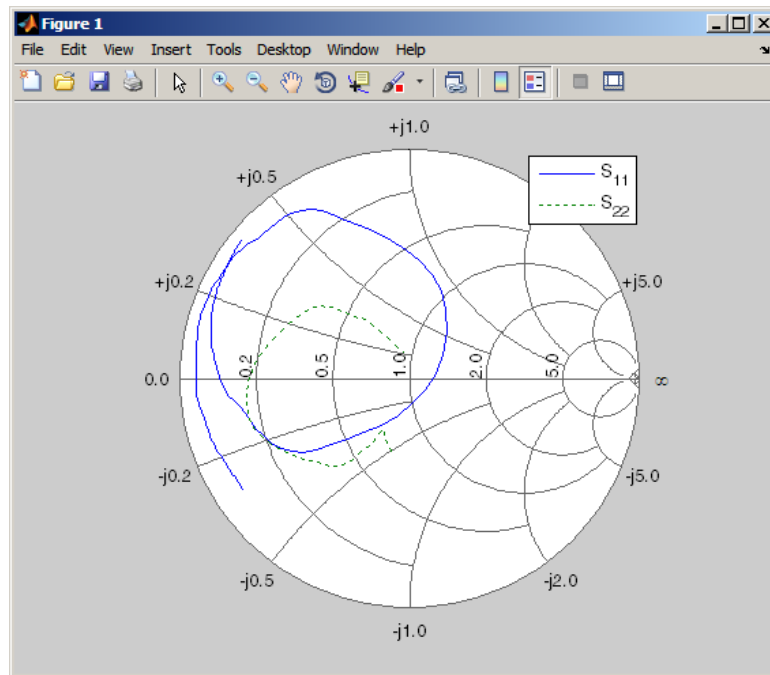

**Note** The plot shows the S-parameters over the frequency range for which network data is specified in the default.amp file — from 1 GHz to 2.9 GHz.

- 2 Type the following set of commands at the MATLAB prompt to use the RF Toolbox `plot` command to plot the amplifier (`SecondCkt`) output power ( $P_{out}$ ) as a function of input power ( $P_{in}$ ), both in decibels referenced to one milliwatt (dBm), on an X-Y plane plot:

```
figure  
plot(SecondCkt, 'Pout', 'dBm');  
legend show
```

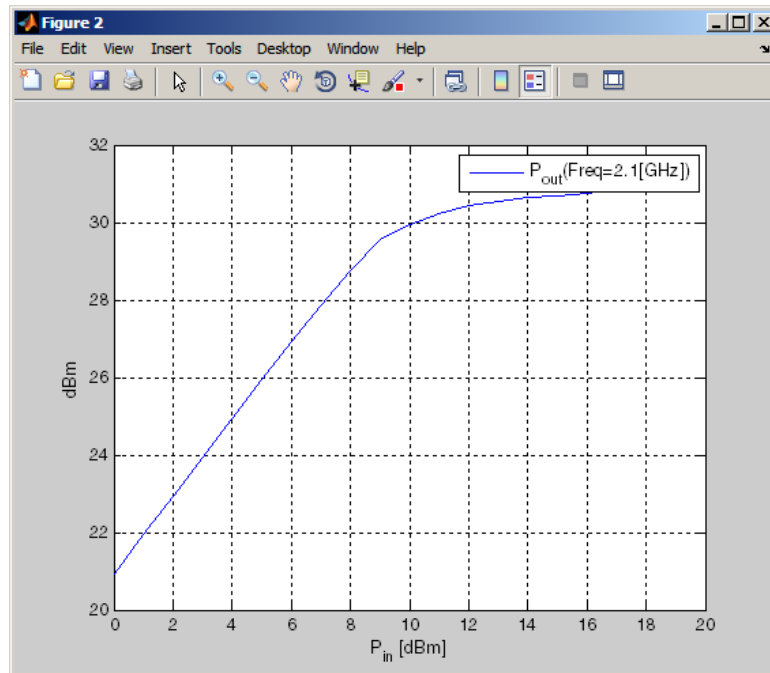

---

**Note** The plot shows the power data at 2.1 GHz because this frequency is the one for which power data is specified in the `default.amp` file.

---

## Build and Simulate the Network

In this part of the example, you create a circuit object to represent the cascaded amplifier and analyze the object in the frequency domain.

- 1 Type the following command at the MATLAB prompt to cascade the three circuit objects to form a new cascaded circuit object, `CascadedCkt`:

```
CascadedCkt = rfckt.cascade('Ckts',{FirstCkt,SecondCkt,...  
    ThirdCkt});
```

- 2 Type the following set of commands at the MATLAB prompt to define the range of frequencies over which to analyze the cascaded circuit, and then run the analysis:

```
f = 1.0e9:1e7:2.9e9;  
analyze(CascadedCkt,f);
```

## Analyze Simulation Results

In this part of the example, you analyze the results of the simulation by plotting data for the circuit object that represents the cascaded amplifier network.

- 1 Type the following set of commands at the MATLAB prompt to use the smith command to plot the  $S_{11}$  and  $S_{22}$  parameters of the cascaded amplifier network on a Z Smith Chart:

```
figure
lineseries2 = smith(CascadedCkt,'S11','S22','z');
set(lineseries2(1),'LineStyle','-','LineWidth',1);
set(lineseries2(2),'LineStyle',':','LineWidth',1);
legend show
```

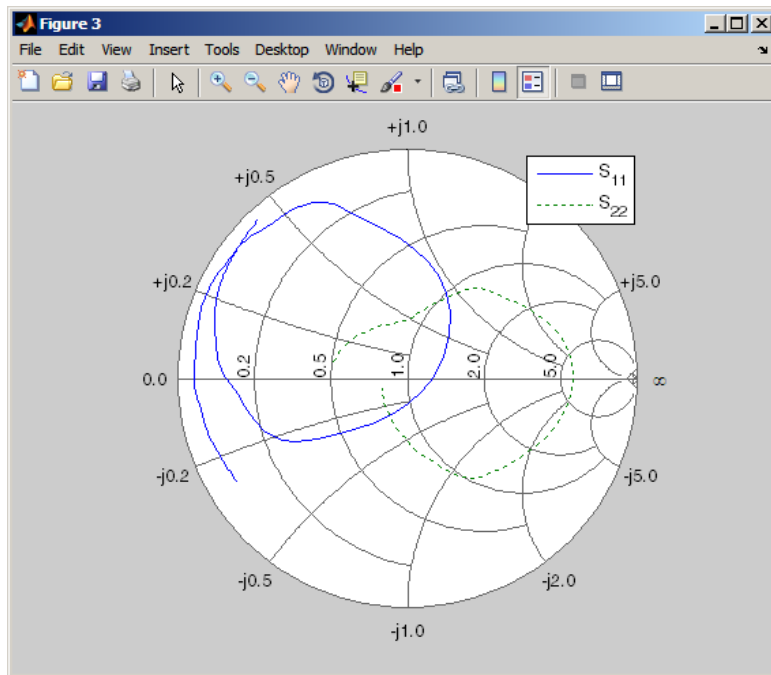

- 2 Type the following set of commands at the MATLAB prompt to use the plot command to plot the  $S_{21}$  parameter of the cascaded network, which represents the network gain, on an X-Y plane:

```
figure  
plot(CascadedCkt, 'S21', 'dB');  
legend show
```

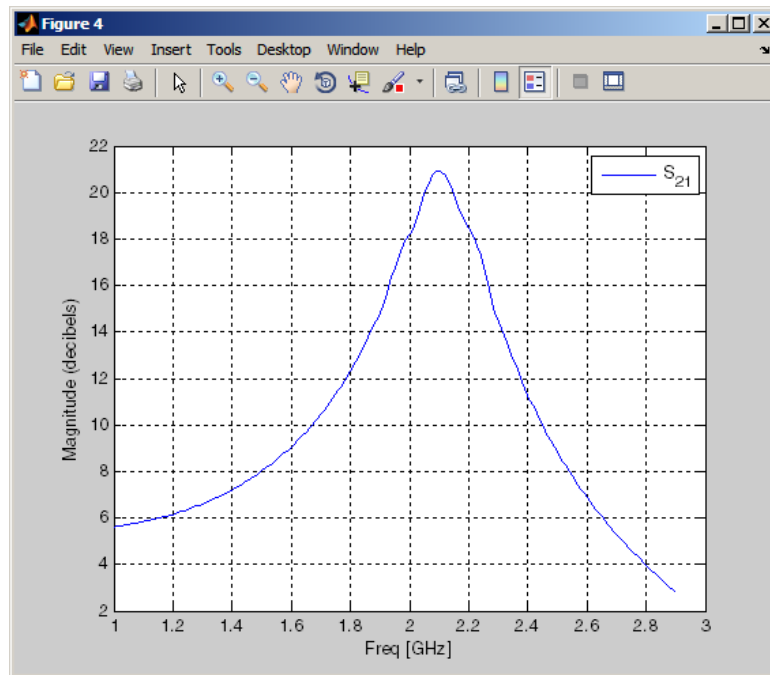

- 3 Type the following set of commands at the MATLAB prompt to use the plot command to create a budget plot of the  $S_{21}$  parameter and the noise figure of the amplifier network:

```
figure
plot(CascadedCkt,'budget', 'S21','NF');
legend show
```

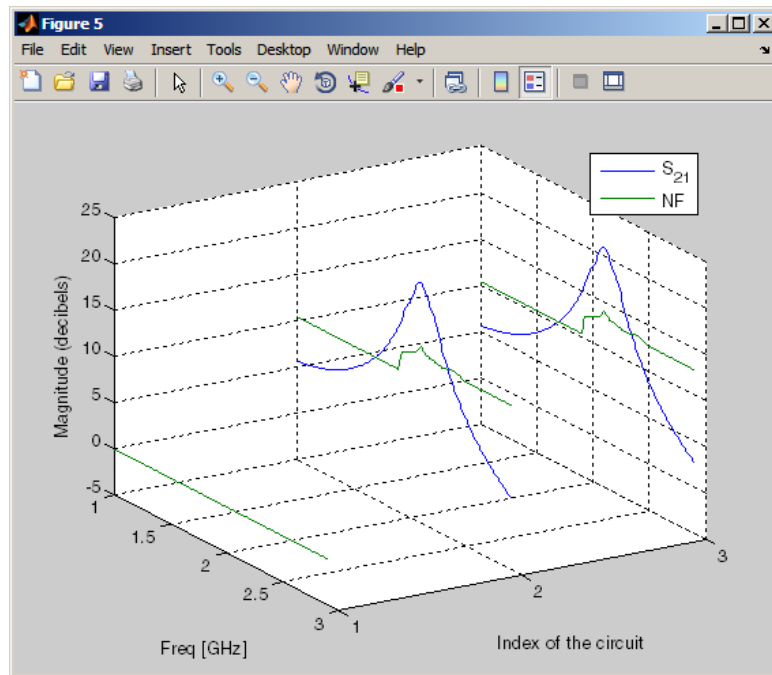

The budget plot shows parameters as a function of frequency by circuit index. Components are indexed based on their position in the network. In this example:

- Circuit index one corresponds to FirstCkt.
- Circuit index two corresponds to SecondCkt.
- Circuit index three corresponds to ThirdCkt.

The curve for each index represents the contributions of the RF components up to and including the component at that index.

# Analyze a Transmission Line

## In this section...

“Overview” on page 1-19

“Build and Simulate the Transmission Line” on page 1-19

“Compute the Transmission Line Transfer Function and Time-Domain Response” on page 1-19

“Export a Verilog-A Model” on page 1-24

## Overview

In this example, you use the RF Toolbox command-line interface to model the time-domain response of a parallel plate transmission line. You analyze the network in the frequency domain, compute and plot the time-domain response of the network, and export a Verilog-A model of the transmission line for use in system-level simulations.

## Build and Simulate the Transmission Line

- 1 Type the following command at the MATLAB prompt to create a circuit (rfckt) object to represent the transmission line, which is 0.1 meters long and 0.05 meters wide:

```
tline = rfckt.parallelplate('LineLength',0.1,'Width',0.05);
```

- 2 Type the following set of commands at the MATLAB prompt to define the range of frequencies over which to analyze the transmission line and then run the analysis:

```
f = [1.0e9:1e7:2.9e9];  
analyze(tline,f);
```

## Compute the Transmission Line Transfer Function and Time-Domain Response

This part of the example illustrates how to perform the following tasks:

- “Calculate the Transfer Function” on page 1-20
- “Fit and Validate the Transfer Function Model” on page 1-20
- “Compute and Plot the Time-Domain Response” on page 1-23

## Calculate the Transfer Function

- 1 Type the following command at the MATLAB prompt to extract the computed S-parameter values and the corresponding frequency values for the transmission line:

```
[S_Params, Freq] = extract(tline, 'S_Parameters');
```

- 2 Type the following command at the MATLAB prompt to compute the transfer function from the frequency response data using the `s2tf` function:

```
TrFunc = s2tf(S_Params);
```

## Fit and Validate the Transfer Function Model

In this part of the example, you fit a rational function model to the transfer function. The toolbox stores the fitting results in an `rfmodel` object. You use the RF Toolbox `freqresp` method to validate the fit of the rational function model.

- 1 Type the following command at the MATLAB prompt to fit a rational function to the computed data and store the result in an `rfmodel` object:

```
RationalFunc = rationalfit(Freq, TrFunc)
```

- 2 Type the following command at the MATLAB prompt to compute the frequency response of the fitted model data:

```
[fresp, freq]=freqresp(RationalFunc, Freq);
```

- 3 Type the following set of commands at the MATLAB prompt to plot the amplitude of the frequency response of the fitted model data and that of the computed data:

```
figure  
plot(freq/1e9, db(fresp), freq/1e9, db(TrFunc));
```



```
xlabel('Frequency, GHz')  
ylabel('Amplitude, dB')  
legend('Fitted Model Data', 'Computed Data')
```

**Note** The amplitude of the model data is very close to the amplitude of the computed data. You can control the tradeoff between model accuracy and model complexity by specifying the optional tolerance argument, `tol`, to the `rationalfit` function, as described in “Represent a Circuit Object with a Model Object” on page 4-5.

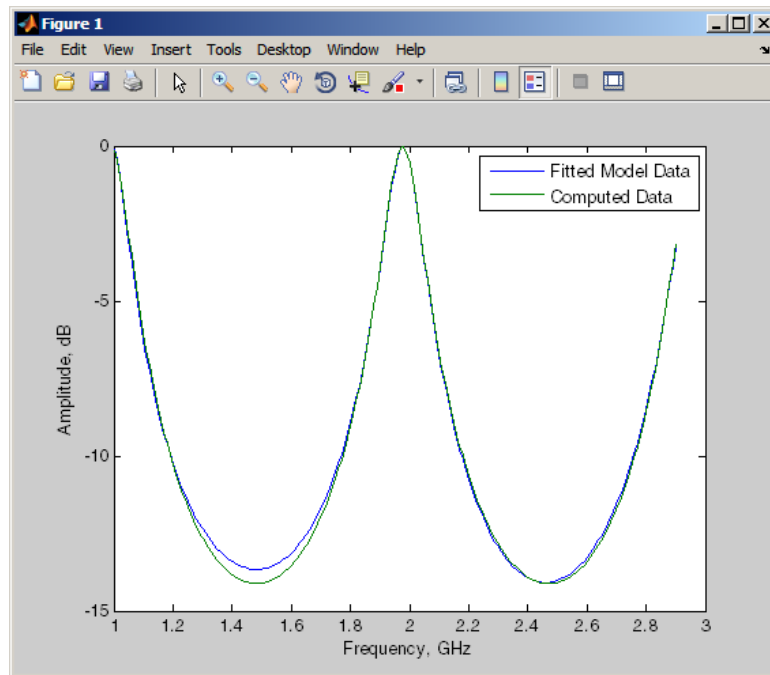

- 4 Type the following set of commands at the MATLAB prompt to plot the phase angle of the frequency response of the fitted model data and that of the computed data:

```
figure  
plot(freq/1e9,unwrap(angle(fresp)),...  
      freq/1e9,unwrap(angle(TrFunc)));  
xlabel('Frequency, GHz')  
ylabel('Phase Angle, radians')  
legend('Fitted Data','Computed Data')
```

**Note** The phase angle of the model data is very close to the phase angle of the computed data.

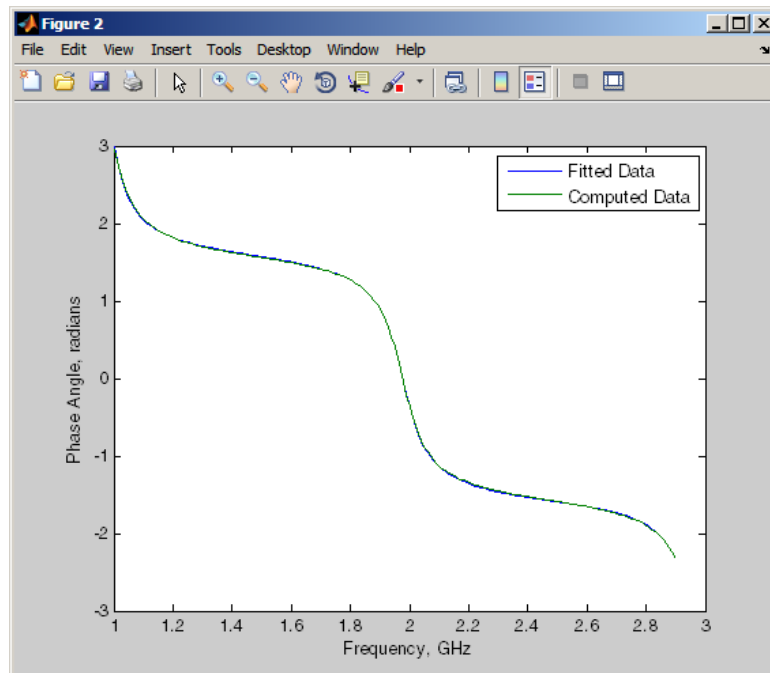

## Compute and Plot the Time-Domain Response

In this part of the example, you compute and plot the time-domain response of the transmission line.

- 1 Type the following set of commands at the MATLAB prompt to create a random input signal and compute the time response, `tresp`, of the fitted model data to the input signal:

```
SampleTime=1e-12;
NumberOfSamples=1e4;
OverSamplingFactor = 25;
InputTime = double((1:NumberOfSamples)')*SampleTime;
InputSignal = ...
    sign(randn(1, ceil(NumberOfSamples/OverSamplingFactor)));
InputSignal = repmat(InputSignal, [OverSamplingFactor, 1]);
InputSignal = InputSignal(:);

[tresp,t]=timeresp(RationalFunc,InputSignal,SampleTime);
```

- 2 Type the following set of commands at the MATLAB prompt to plot the time response of the fitted model data:

```
figure
plot(t,tresp);
xlabel('Time (seconds)')
ylabel('Response to Random Input Signal')
```

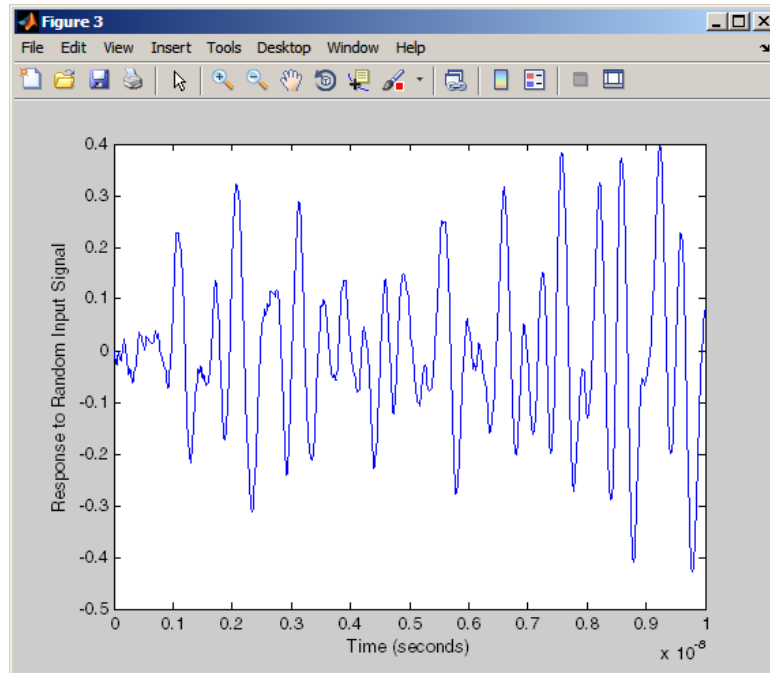

## Export a Verilog-A Model

In this part of the example, you export a Verilog-A model of the transmission line. You can use this model in other simulation tools for detailed time-domain analysis and system simulations.

The following code illustrates how to use the `writева` method to write a Verilog-A module for `RationalFunc` to the file `tline.va`. The module has one input, `tline_in`, and one output, `tline_out`. The method returns a status of `True`, if the operation is successful, and `False` if it is unsuccessful.

```
status = writева(RationalFunc,'tline','tline_in','tline_out')
```

For more information on the `writева` method and its arguments, see the `writева` reference page. For more information on Verilog-A models, see “Export a Verilog-A Model” on page 4-5.

# RF Objects

---

- “RF Data Objects” on page 2-2
- “RF Circuit Objects” on page 2-4
- “RF Model Objects” on page 2-10
- “RF Network Parameter Objects” on page 2-12

## RF Data Objects

In this section...
“Overview” on page 2-2
“Types of Data” on page 2-2
“Available Data Objects” on page 2-2
“Data Object Methods” on page 2-3

### Overview

RF Toolbox software uses data (`rfddata`) objects to store:

- Component data created from files or from information that you specify in the MATLAB workspace.
- Analyzed data from a frequency-domain simulation of a circuit object.

You can perform basic tasks, such as plotting and network parameter conversion, on the data stored in these objects. However, data objects are primarily used to store data for use by other RF objects.

### Types of Data

The toolbox uses RF data objects to store one or more of the following types of data:

- Network parameters
- Spot noise
- Noise figure
- Third-order intercept point (IP<sub>3</sub>)
- Power out versus power in

### Available Data Objects

The following table lists the available `rfddata` object constructors and describes the data the corresponding objects represent. For more information

on a particular object, follow the link in the table to the reference page for that object.

<b>Constructor</b>	<b>Description</b>
<code>rfdata.data</code>	Data object containing network parameter data
<code>rfdata.ip3</code>	Data object containing IP3 information
<code>rfdata.mixerspur</code>	Data object containing mixer spur information from an intermodulation table
<code>rfdata.network</code>	Data object containing network parameter information
<code>rfdata.nf</code>	Data object containing noise figure information
<code>rfdata.noise</code>	Data object containing noise information
<code>rfdata.power</code>	Data object containing power and phase information

## Data Object Methods

The following table lists the methods of the data objects, the types of objects on which each can act, and the purpose of each method.

<b>Method</b>	<b>Types of Objects</b>	<b>Purpose</b>
<code>extract</code>	<code>rfdata.data</code> , <code>rfdata.network</code>	Extract specified network parameters from a circuit or data object and return the result in an array
<code>read</code>	<code>rfdata.data</code>	Read RF data parameters from a file to a new or existing data object.
<code>write</code>	<code>rfdata.data</code>	Write RF data from a data object to a file.

## RF Circuit Objects

In this section...
“Overview of RF Circuit Objects” on page 2-4
“Components Versus Networks” on page 2-4
“Available Components and Networks” on page 2-5
“Circuit Object Methods” on page 2-7

### Overview of RF Circuit Objects

RF Toolbox software uses circuit (`rfckt`) objects to represent the following components:

- Circuit components such as amplifiers, transmission lines, and ladder filters
- RLC network components
- Networks of RF components

The toolbox represents each type of component and network with a different object. You use these objects to analyze components and networks in the frequency domain.

### Components Versus Networks

You define component behavior using network parameters and physical properties.

To specify an individual RF component:

- 1** Construct a circuit object to represent the component.
- 2** Specify or import component data.

You define network behavior by specifying the components that make up the network. These components can be either individual components (such as amplifiers and transmission lines) or other networks.



To specify an RF network:

- 1 Build circuit objects to represent the network components.
- 2 Construct a circuit object to represent the network.

---

**Note** This object defines how to connect the network components. However, the network is empty until you specify the components that it contains.

---

- 3 Specify, as the `Ckts` property of the object that represents the network, a list of components that make up the network.

These procedures are illustrated by example in “Model a Cascaded RF Network” on page 1-11.

## Available Components and Networks

To create circuit objects that represent components, you use constructors whose names describe the components. To create circuit objects that represent networks, you use constructors whose names describe how the components are connected together.

The following table lists the available `rfckt` object constructors and describes the components or networks the corresponding objects represent. For more information on a particular object, follow the link in the table to the reference page for that object.

Constructor	Description
<code>rfckt.amplifier</code>	Amplifier, described by an <code>rfdata</code> object
<code>rfckt.cascade</code>	Cascaded network, described by the list of components and networks that comprise it
<code>rfckt.coaxial</code>	Coaxial transmission line, described by dimensions and electrical characteristics

<b>Constructor</b>	<b>Description</b>
<code>rfckt.cpw</code>	Coplanar waveguide transmission line, described by dimensions and electrical characteristics
<code>rfckt.datafile</code>	General circuit, described by a data file
<code>rfckt.delay</code>	Delay line, described by loss and delay
<code>rfckt.hybrid</code>	Hybrid connected network, described by the list of components and networks that comprise it
<code>rfckt.hybridg</code>	Inverse hybrid connected network, described by the list of components and networks that comprise it
<code>rfckt.lcbandpasspi</code>	LC bandpass pi network, described by LC values
<code>rfckt.lcbandpasstee</code>	LC bandpass tee network, described by LC values
<code>rfckt.lcbandstoppi</code>	LC bandstop pi network, described by LC values
<code>rfckt.lcbandstoptee</code>	LC bandstop tee network, described by LC values
<code>rfckt.lchighpasspi</code>	LC highpass pi network, described by LC values
<code>rfckt.lchighpasstee</code>	LC highpass tee network, described by LC values
<code>rfckt.lclowpasspi</code>	LC lowpass pi network, described by LC values
<code>rfckt.lclowpasstee</code>	LC lowpass tee network, described by LC values
<code>rfckt.microstrip</code>	Microstrip transmission line, described by dimensions and electrical characteristics
<code>rfckt.mixer</code>	Mixer, described by an <code>rfdata</code> object
<code>rfckt.parallel</code>	Parallel connected network, described by the list of components and networks that comprise it
<code>rfckt.parallelplate</code>	Parallel-plate transmission line, described by dimensions and electrical characteristics

<b>Constructor</b>	<b>Description</b>
<code>rfckt.passive</code>	Passive component, described by network parameters
<code>rfckt.rlcgline</code>	RLCG transmission line, described by RLCG values
<code>rfckt.series</code>	Series connected network, described by the list of components and networks that comprise it
<code>rfckt.seriesrlc</code>	Series RLC network, described by RLC values
<code>rfckt.shuntrlc</code>	Shunt RLC network, described by RLC values
<code>rfckt.twowire</code>	Two-wire transmission line, described by dimensions and electrical characteristics
<code>rfckt.txline</code>	General transmission line, described by dimensions and electrical characteristics

## Circuit Object Methods

The following table lists the methods of the circuit objects, the types of objects on which each can act, and the purpose of each method.

<b>Method</b>	<b>Types of Objects</b>	<b>Purpose</b>
<code>analyze</code>	All circuit objects	Analyze a circuit object in the frequency domain.
<code>calculate</code>	All circuit objects	Calculate specified parameters for a circuit object.
<code>copy</code>	All circuit objects	Copy a circuit or data object.
<code>extract</code>	All circuit objects	Extract specified network parameters from a circuit or data object, and return the result in an array.
<code>getdata</code>	All circuit objects	Get data object containing analyzed result of a specified circuit object.

<b>Method</b>	<b>Types of Objects</b>	<b>Purpose</b>
getz0	rfckt.txline, rfckt.rlogline, rfckt.twowire, rfckt.parallelplate, rfckt.coaxial, rfdata.microstrip, rfckt.cpw	Get characteristic impedance of a transmission line.
listformat	All circuit objects	List valid formats for a specified circuit object parameter.
listparam	All circuit objects	List valid parameters for a specified circuit object.
loglog	All circuit objects	Plot specified circuit object parameters using a log-log scale.
plot	All circuit objects	Plot the specified circuit object parameters on an X-Y plane.
plotyy	All circuit objects	Plot the specified object parameters with y-axes on both the left and right sides.
polar	All circuit objects	Plot the specified circuit object parameters on polar coordinates.
read	rfckt.datafile, rfckt.passive, rfckt.amplifier, rfckt.mixer	Read RF data from a file to a new or existing circuit object.
restore	rfckt.datafile, rfckt.passive, rfckt.amplifier, rfckt.mixer	Restore data to original frequencies of NetworkData for plotting.
semilogx	All circuit objects	Plot the specified circuit object parameters using a log scale for the X-axis

<b>Method</b>	<b>Types of Objects</b>	<b>Purpose</b>
semilogy	All circuit objects	Plot the specified circuit object parameters using a log scale for the Y-axis
smith	All circuit objects	Plot the specified circuit object parameters on a Smith chart.
write	All circuit objects	Write RF data from a circuit object to a file.

## RF Model Objects

In this section...
“Overview of RF Model Objects” on page 2-10
“Available Model Objects” on page 2-10
“Model Object Methods” on page 2-10

### Overview of RF Model Objects

RF Toolbox software uses model (`rfmodel`) objects to represent components and measured data mathematically for computing information such as time-domain response. Each type of model object uses a different mathematical model to represent the component.

RF model objects provide a high-level component representation for use after you perform detailed analysis using RF circuit objects. Use RF model objects to:

- Compute time-domain figures of merit for RF components
- Export Verilog-A models of RF components

### Available Model Objects

The following table lists the available `rfmodel` object constructors and describes the model the corresponding objects use. For more information on a particular object, follow the link in the table to the reference page for that object.

Constructor	Description
<code>rfmodel.rational</code>	Rational function model

### Model Object Methods

The following table lists the methods of the model objects, the types of objects on which each can act, and the purpose of each method.

<b>Method</b>	<b>Types of Objects</b>	<b>Purpose</b>
freqresp	All model objects	Compute the frequency response of a model object.
timeresp	All model objects	Compute the time response of a model object.
writeva	All model objects	Write data from a model object to a file.

## RF Network Parameter Objects

### In this section...

“Overview of Network Parameter Objects” on page 2-12

“Available Network Parameter Objects” on page 2-12

“Network Parameter Object Functions” on page 2-13

### Overview of Network Parameter Objects

RF Toolbox software offers network parameter objects for:

- Importing network parameter data from a Touchstone file.
- Converting network parameters.
- Analyzing network parameter data.

Unlike circuit, model, and data objects, you can use existing RF Toolbox functions to operate directly on network parameter objects.

### Available Network Parameter Objects

The following table lists the available network parameter objects and the functions that are used to construct them. For more information on a particular object, follow the link in the table to the reference page for that functions.

Network Parameter Object Type	Network Parameter Object Function
ABCD Parameter object	<a href="#">abcdparameters</a>
Hybrid-g parameter object	<a href="#">gparameters</a>
Hybrid parameter object	<a href="#">hparameters</a>
S-parameter object	<a href="#">sparameters</a>
Y-parameter object	<a href="#">yparameters</a>
Z-parameter object	<a href="#">zparameters</a>



## Network Parameter Object Functions

The following table lists the functions that accept network parameter objects as inputs, the types of objects on which each can act, and the purpose of each function.

Function	Types of Objects	Purpose
abcdparameters	All network parameter objects	Convert any network parameters to ABCD parameters
gparameters	All network parameter objects	Convert any network parameters to hybrid-g parameters
hparameters	All network parameter objects	Convert any network parameters to hybrid parameters
sparameters	All network parameter objects	Convert any network parameters to S-parameters
yparameters	All network parameter objects	Convert any network parameters to Y-parameters
zparameters	All network parameter objects	Convert any network parameters to Z-parameters
cascadesparams	S-parameter objects	Cascade S-parameters
deembedsparams	S-parameter objects	De-embed S-parameters
gammain	S-parameter objects	Calculate input reflection coefficient
gammaml	S-parameter objects	Calculate load reflection coefficient
gammams	S-parameter objects	Calculate source reflection coefficient

<b>Function</b>	<b>Types of Objects</b>	<b>Purpose</b>
gammaout	S-parameter objects	Calculate output reflection coefficient
ispassive	S-parameter objects	Check S-parameter data passivity
makepassive	S-parameter objects	Make S-parameter data passive
newref	S-parameter objects	Change reference impedance
powergain	S-parameter objects	Calculate power gain
rfplot	S-parameter objects	Plot network parameters
rfinterp1	All network parameter objects	Interpolate network parameters at new frequencies
rfparam	All network parameter objects	Extract vector of network parameters
s2tf	S-parameter objects	Create transfer function from S-parameters
stabilityk	S-parameter objects	Calculate stability factor $K$ of 2-port network
stabilitymu	S-parameter objects	Calculate stability factor $\mu$ of 2-port network
smith	All network parameter objects	Plot network parameter data on a Smith Chart

# Model an RF Component

---

- “Create RF Objects” on page 3-2
- “Specify or Import Component Data” on page 3-5
- “Specify Operating Conditions” on page 3-17
- “Process File Data for Analysis” on page 3-19
- “Analyze and Plot RF Components” on page 3-25
- “Export Component Data to a File” on page 3-38
- “Basic Operations with RF Objects” on page 3-41

## Create RF Objects

In this section...
“Construct a New Object” on page 3-2
“Copy an Existing Object” on page 3-4

### Construct a New Object

You can create any `rfdata`, `rfckt` or `rfmodel` object by calling the object constructor. You can create an `rfmodel` object by fitting a rational function to passive component data.

This section contains the following topics:

- “Call the Object Constructor” on page 3-2
- “Fit a Rational Function to Passive Component Data” on page 3-3

### Call the Object Constructor

To create a new RF object with default property values, you call the object constructor without any arguments:

```
h = objecttype.objectname
```

where:

- `h` is the handle to the new object.
- `objecttype` is the object type (`rfdata`, `rfckt`, or `rfmodel`).
- `objectname` is the object name.

For example, to create an RLCG transmission line object, type:

```
h = rfckt.rlcgline
```

because the RLCG transmission line object is a circuit (`rfckt`) object named `rlcgline`.

The following code illustrates how to call the object constructor to create a microstrip transmission line object with default property values. The output `t1` is the handle of the newly created transmission line object.

```
t1 = rfckt.microstrip
```

RF Toolbox software lists the properties of the transmission line you created along with the associated default property values.

```
t1 =  
      Name: 'Microstrip Transmission Line'  
      nPort: 2  
AnalyzedResult: []  
      LineLength: 0.0100  
      StubMode: 'NotAStub'  
      Termination: 'NotApplicable'  
      Width: 6.0000e-004  
      Height: 6.3500e-004  
      Thickness: 5.0000e-006  
      EpsilonR: 9.8000  
      SigmaCond: Inf  
      LossTangent: 0
```

The `rfckt.microstrip` reference page describes these properties in detail.

### **Fit a Rational Function to Passive Component Data**

You can create a model object by fitting a rational function to passive component data. You use this approach to create a model object that represents one of the following using a rational function:

- A circuit object that you created and analyzed.
- Data that you imported from a file.

For more information, see “Fit a Model Object to Circuit Object Data” on page 3-36.

## Copy an Existing Object

You can create a new object with the same property values as an existing object by using the copy function to copy the existing object. This function is useful if you have an object that is similar to one you want to create.

For example,

```
t2 = copy(t1);
```

creates a new object, t2, which has the same property values as the microstrip transmission line object, t1.

You can later change specific property values for this copy. For information on modifying object properties, see “Specify or Import Component Data” on page 3-5.

---

**Note** The syntax `t2 = t1` copies only the object handle and does not create a new object.

---

## Specify or Import Component Data

### In this section...

“RF Object Properties” on page 3-5

“Set Property Values” on page 3-5

“Import Property Values from Data Files” on page 3-8

“Use Data Objects to Specify Circuit Properties” on page 3-11

“Retrieve Property Values” on page 3-14

“Reference Properties Directly Using Dot Notation” on page 3-16

## RF Object Properties

Object properties specify the behavior of an object. You can specify object properties, or you can import them from a data file. To learn about properties that are specific to a particular type of circuit, data, or model object, see the reference page for that type of object.

---

**Note** The “RF Circuit Objects” on page 2-4, “RF Data Objects” on page 2-2, “RF Model Objects” on page 2-10 sections list the available types of objects and provide links to their reference pages.

---

## Set Property Values

You can specify object property values when you construct an object or you can modify the property values of an existing object.

This section contains the following topics:

- “Specify Property Values at Construction” on page 3-5
- “Change Property Values of an Existing Object” on page 3-7

## Specify Property Values at Construction

To set a property when you construct an object, include a comma-separated list of one or more property/value pairs in the argument list of the object

construction command. A property/value pair consists of the arguments '*PropertyName*' ,*PropertyValue*, where:

- *PropertyName* is a string specifying the property name. The name is case-insensitive. In addition, you need only type enough letters to uniquely identify the property name. For example, 'st' is sufficient to refer to the StubMode property.

---

**Note** You must use single quotation marks around the property name.

---

- *PropertyValue* is the value to assign to the property.

Include as many property names in the argument list as there are properties you want to set. Any property values that you do not set retain their default values. The circuit and data object reference pages list the valid values as well as the default value for each property.

This section contains examples of how to perform the following tasks:

- “Construct Components with Specified Properties” on page 3-6
- “Construct Networks of Specified Components” on page 3-7

**Construct Components with Specified Properties.** The following code creates a coaxial transmission line circuit object to represent a coaxial transmission line that is 0.05 meters long. Notice that the toolbox lists the available properties and their values.

```
t1 = rfckt.coaxial('LineLength',0.05)
```

```
t1 =
```

```
          Name: 'Coaxial Transmission Line'  
          nPort: 2  
AnalyzedResult: []  
          LineLength: 0.0500  
          StubMode: 'NotAStub'  
          Termination: 'NotApplicable'  
          OuterRadius: 0.0026
```



```

InnerRadius: 7.2500e-004
      MuR: 1
      EpsilonR: 2.3000
      LossTangent: 0
      SigmaCond: Inf

```

**Construct Networks of Specified Components.** To combine a set of RF components and existing networks to form an RF network, you create a network object with the `Ckts` property set to an array containing the handles of all the circuit objects in the network.

Suppose you have the following RF components:

```

t1 = rfckt.coaxial('LineLength',0.05);
a1 = rfckt.amplifier;
t2 = rfckt.coaxial('LineLength',0.1);

```

The following code creates a cascaded network of these components:

```

casc_network = rfckt.cascade('Ckts',{t1,a1,t2});

```

### Change Property Values of an Existing Object

There are two ways to change the properties of an existing object:

- Using the `set` command
- Using structure-like assignments called dot notation

This section discusses the first option. For details on the second option, see “Reference Properties Directly Using Dot Notation” on page 3-16.

To modify the properties of an existing object, use the `set` command with one or more property/value pairs in the argument list. The general syntax of the command is

```

set(h,Property1',value1,'Property2',value2,...)

```

where

- `h` is the handle of the object.

- `'Property1',value1,'Property2',value2,...` is the list of property/value pairs.

For example, the following code creates a default coaxial transmission line object and changes it to a series stub with open termination.

```
t1 = rfckt.coaxial;  
set(t1,'StubMode','series','Termination','open')
```

---

**Note** You can use the `set` command without specifying any property/value pairs to display a list of all properties you can set for a specific object. This example lists the properties you can set for the coaxial transmission line `t1`:

```
set(t1)  
  
ans =  
    LineLength: {}  
      StubMode: {}  
  Termination: {}  
  OuterRadius: {}  
  InnerRadius: {}  
           MuR: {}  
     EpsilonR: {}  
  LossTangent: {}  
   SigmaCond: {}
```

---

## Import Property Values from Data Files

RF Toolbox software lets you import industry-standard data files, MathWorks AMP files, and Agilent P2D and S2D files into specific objects. This import capability lets you simulate the behavior of measured components.

You can import the following file formats:

- Industry-standard file formats — Touchstone SNP, YNP, ZNP, HNP, and GNP formats specify the network parameters and noise information for measured and simulated data.

For more information on Touchstone files, see [www.vhdl.org/pub/ibis/connector/touchstone\\_spec11.pdf](http://www.vhdl.org/pub/ibis/connector/touchstone_spec11.pdf).

- Agilent P2D file format — Specifies amplifier and mixer large-signal, power-dependent network parameters, noise data, and intermodulation tables for several operating conditions, such as temperature and bias values.

The P2D file format lets you import system-level verification models of amplifiers and mixers.

- Agilent S2D file format — Specifies amplifier and mixer network parameters with gain compression, power-dependent  $S_{21}$  parameters, noise data, and intermodulation tables for several operating conditions.

The S2D file format lets you import system-level verification models of amplifiers and mixers.

- MathWorks amplifier (AMP) file format — Specifies amplifier network parameters, output power versus input power, noise data and third-order intercept point.

For more information about .amp files, see Appendix A, “AMP File Format”.

This section contains the following topics:

- “Objects Used to Import Data from a File” on page 3-9
- “How to Import Data Files” on page 3-10

## Objects Used to Import Data from a File

One data object and three circuit objects accept data from a file. The following table lists the objects and any corresponding data format each supports.

Object	Description	Supported Format(s)
rfdata.data	Data object containing network parameter data, noise figure, and third-order intercept point	Touchstone, AMP, P2D, S2D
rfckt.amplifier	Amplifier	Touchstone, AMP, P2D, S2D

<b>Object</b>	<b>Description</b>	<b>Supported Format(s)</b>
rfckt.mixer	Mixer	Touchstone, AMP, P2D, S2D
rfckt.passive	Generic passive component	Touchstone

### **How to Import Data Files**

To import file data into a circuit or data object at construction, use a `read` command of the form:

```
obj = read(obj_type, 'filename');
```

where

- `obj` is the handle of the circuit or data object.
- `obj_type` is the type of object in which to store the data, from the list of objects that accept file data shown in “Objects Used to Import Data from a File” on page 3-9.
- `filename` is the name of the file that contains the data.

For example,

```
ckt_obj=read(rfckt.amplifier, 'default.amp');
```

imports data from the file `default.amp` into an `rfckt.amplifier` object.

You can also import file data into an existing circuit object. The following commands are equivalent to the previous command:

```
ckt_obj=rfckt.amplifier;  
read(ckt_obj, 'default.amp');
```

---

**Note** When you import component data from a `.p2d` or `.s2d` file, properties are defined for several operating conditions. You must select an operating condition to specify the object behavior, as described in “Specify Operating Conditions” on page 3-17.

---

## Use Data Objects to Specify Circuit Properties

To specify a circuit object property using a data object, use the `set` command with the name of the data object as the value in the property/value pair.

For example, suppose you have the following `rfckt.amplifier` and `rfdata.nf` objects:

```
amp = rfckt.amplifier
f = 2.0e9;
nf = 13.3244;
nfdata = rfdata.nf('Freq',f,'Data',nf)
```

The following command uses the `rfdata.nf` data object to specify the `rfckt.amplifier` `NoiseData` property:

```
set(amp,'NoiseData',nfdata)
```

## Set Circuit Object Properties Using Data Objects

In this example, you create a circuit object. Then, you create three data objects and use them to update the properties of the circuit object.

- 1 Create an amplifier object.** This circuit object, `rfckt.amplifier`, has a network parameter, noise data, and nonlinear data properties. These properties control the frequency response of the amplifier, which is stored in the `AnalyzedResult` property. By default, all amplifier properties contain values from the `default.amp` file. The `NetworkData` property is an `rfdata.network` object that contains 50-ohm S-parameters. The `NoiseData` property is an `rfdata.noise` object that contains frequency-dependent spot noise data. The `NonlinearData` property is an `rfdata.power` object that contains output power and phase information.

```
amp = rfckt.amplifier
```

The toolbox displays the following output:

```
amp =  
  
      Name: 'Amplifier'  
      nPort: 2  
  AnalyzedResult: [1x1 rfddata.data]  
      IntpType: 'Linear'  
      NetworkData: [1x1 rfddata.network]  
      NoiseData: [1x1 rfddata.noise]  
      NonlinearData: [1x1 rfddata.power]
```

**2 Create a data object that stores network data.** Type the following set of commands at the MATLAB prompt to create an `rfddata.network` object that stores the 2-port Y-parameters at 2.08 GHz, 2.10 GHz, and 2.15 GHz. Later in this example, you use this data object to update the `NetworkData` property of the `rfckt.amplifier` object.

```
f = [2.08 2.10 2.15]*1.0e9;  
y(:, :, 1) = [-.0090-.0104i, .0013+.0018i; ...  
             -.2947+.2961i, .0252+.0075i];  
y(:, :, 2) = [-.0086-.0047i, .0014+.0019i; ...  
             -.3047+.3083i, .0251+.0086i];  
y(:, :, 3) = [-.0051+.0130i, .0017+.0020i; ...  
             -.3335+.3861i, .0282+.0110i];  
  
netdata = rfddata.network('Type','Y_PARAMETERS',...  
                          'Freq',f,'Data',y)
```

The toolbox displays the following output:

```
netdata =  
  
      Name: 'Network parameters'  
      Type: 'Y_PARAMETERS'  
      Freq: [3x1 double]  
      Data: [2x2x3 double]  
      Z0: 50
```

**3 Create a data object that stores noise figure values.** Type the following set of commands at the MATLAB prompt to create a `rfdata.nf` object that contains noise figure values, in dB, at seven different frequencies. Later in this example, you use this data object to update the `NoiseData` property of the `rfckt.amplifier` object.

```
f = [1.93 2.06 2.08 2.10 2.15 2.30 2.40]*1.0e9;  
nf=[12.4521 13.2466 13.6853 14.0612 13.4111 12.9499 13.3244];  
  
nfdata = rfdata.nf('Freq',f,'Data',nf)
```

The toolbox displays the following output:

```
nfdata =  
  
    Name: 'Noise figure'  
    Freq: [7x1 double]  
    Data: [7x1 double]
```

**4 Create a data object that stores output third-order intercept points.** Type the following command at the MATLAB prompt to create a `rfdata.ip3` object that contains an output third-order intercept point of 8.45 watts, at 2.1 GHz. Later in this example, you use this data object to update the `NonlinearData` property of the `rfckt.amplifier` object.

```
ip3data = rfdata.ip3('Type','OIP3','Freq',2.1e9,'Data',8.45)
```

The toolbox displays the following output:

```
ip3data =  
  
    Name: '3rd order intercept'  
    Type: 'OIP3'  
    Freq: 2.1000e+009  
    Data: 8.4500
```

**5 Update the properties of the amplifier object.** Type the following set of commands at the MATLAB prompt to update the `NetworkData`, `NoiseData`, and `NonlinearData` properties of the amplifier object with the data objects you created in the previous steps:

```
amp.NetworkData = netdata;  
amp.NoiseData = nfddata;  
amp.NonlinearData = ip3data;
```

## Retrieve Property Values

You can retrieve one or more property values of an existing object using the `get` command.

This section contains the following topics:

- “Retrieve Specified Property Values” on page 3-14
- “Retrieve All Property Values” on page 3-15

## Retrieve Specified Property Values

To retrieve specific property values for an object, use the `get` command with the following syntax:

```
PropertyValue = get(h,PropertyName)
```

where

- *PropertyValue* is the value assigned to the property.
- *h* is the handle of the object.
- *PropertyName* is a string specifying the property name.

For example, suppose you have the following coaxial transmission line:

```
h2 = rfckt.coaxial;
```



The following code retrieves the value of the inner radius and outer radius for the coaxial transmission line:

```
ir = get(h2,'InnerRadius')  
or = get(h2,'OuterRadius')
```

```
ir =  
    7.2500e-004
```

```
or =  
    0.0026
```

### Retrieve All Property Values

To display a list of properties associated with a specific object as well as their current values, use the `get` command without specifying a property name.

For example:

```
get(h2)  
    Name: 'Coaxial Transmission Line'  
    nPort: 2  
    AnalyzedResult: []  
    LineLength: 0.0100  
    StubMode: 'NotAStub'  
    Termination: 'NotApplicable'  
    OuterRadius: 0.0026  
    InnerRadius: 7.2500e-004  
    MuR: 1  
    EpsilonR: 2.3000  
    LossTangent: 0  
    SigmaCond: Inf
```

---

**Note** This list includes read-only properties that do not appear when you type `set(h2)`. For a coaxial transmission line object, the read-only properties are `Name`, `nPort`, and `AnalyzedResult`. The `Name` and `nPort` properties are fixed by the toolbox. The `AnalyzedResult` property value is calculated and set by the toolbox when you analyze the component at specified frequencies.

---

## Reference Properties Directly Using Dot Notation

An alternative way to query for or modify property values is by structure-like referencing. The field names for RF objects are the property names, so you can retrieve or modify property values with the structure-like syntax.

- *PropertyValue = rfobj.PropertyName* stores the value of the *PropertyName* property of the *rfobj* object in the *PropertyValue* variable. This command is equivalent to *PropertyValue = get(rfobj, 'PropertyName')*.
- *rfobj.PropertyName = PropertyValue* sets the value of the *PropertyName* property to *PropertyValue* for the *rfobj* object. This command is equivalent to *set(rfobj, 'PropertyName', PropertyValue)*.

For example, typing

```
ckt = rfckt.amplifier('IntpType', 'cubic');  
ckt.IntpType
```

gives the value of the property *IntpType* for the circuit object *ckt*.

```
ans =  
    Cubic
```

Similarly,

```
ckt.IntpType = 'linear';
```

resets the interpolation method to linear.

You do not need to type the entire field name or use uppercase characters. You only need to type the minimum number of characters sufficient to identify the property name uniquely. Thus entering the commands

```
ckt = rfckt.amplifier('IntpType', 'cubic');  
ckt.in
```

also produces

```
ans =  
    Cubic
```

## Specify Operating Conditions

### In this section...

“Available Operating Conditions” on page 3-17

“Set Operating Conditions” on page 3-17

“Display Available Operating Condition Values” on page 3-18

### Available Operating Conditions

Agilent P2D and S2D files contain simulation results at one or more operating conditions. Operating conditions define the independent parameter settings that are used when creating the file data. The specified conditions differ from file to file.

When you import component data from a .p2d or .s2d file, the object contains property values for several operating conditions. The available conditions depend on the data in the file. By default, RF Toolbox software defines the object behavior using the property values that correspond to the operating conditions that appear first in the file. To use other property values, you must select a different operating condition.

### Set Operating Conditions

To set the operating conditions of a circuit or data object, use a `setop` command of the form:

```
setop(, 'Condition1', value1, ..., 'ConditionN', valueN, ...)
```

where

- is the handle of the circuit or data object.
- *Condition1, value1, ..., ConditionN, valueN* are the condition/value pairs that specify the operating condition.

For example,

```
setop(myP2d, 'BiasL', 2, 'BiasU', 6.3)
```

specifies an operating condition of  $\text{BiasL} = 2$  and  $\text{BiasU} = 6.3$  for *myp2d*.

## **Display Available Operating Condition Values**

To display a list of available operating condition values for a circuit or data object, use the `setop` method.

```
setop(obj)
```

displays the available values for all operating conditions of the object *obj*.

```
setop(obj, 'Condition1')
```

displays the available values for *Condition1*.

## Process File Data for Analysis

### In this section...

“Convert Single-Ended S-Parameters to Mixed-Mode S-Parameters” on page 3-19

“Extract M-Port S-Parameters from N-Port S-Parameters” on page 3-21

“Cascade N-Port S-Parameters” on page 3-23

## Convert Single-Ended S-Parameters to Mixed-Mode S-Parameters

After you import file data (as described in “Import Property Values from Data Files” on page 3-8), you can convert a matrix of single-ended S-parameter data to a matrix of mixed-mode S-parameters.

This section contains the following topics:

- “Functions for Converting S-Parameters” on page 3-19
- “Convert S-Parameters” on page 3-20

### Functions for Converting S-Parameters

To convert between 4-port single-ended S-parameter data and 2-port differential-, common-, and cross-mode S-parameters, use one of these functions:

- `s2scc` — Convert 4-port, single-ended S-parameters to 2-port, common-mode S-parameters ( $S_{cc}$ ).
- `s2scd` — Convert 4-port, single-ended S-parameters to 2-port, cross-mode S-parameters ( $S_{cd}$ ).
- `s2sdc` — Convert 4-port, single-ended S-parameters to cross-mode S-parameters ( $S_{dc}$ ).
- `s2sdd` — Convert 4-port, single-ended S-parameters to 2-port, differential-mode S-parameters ( $S_{dd}$ ).

To perform the above conversions all at once, or to convert larger data sets, use one of these functions:

- `s2smm` — Convert 4N-port, single-ended S-parameters to 2N-port, mixed-mode S-parameters.
- `smm2s` — Convert 2N-port, mixed-mode S-parameters to 4N-port, single-ended S-parameters.

Conversion functions support a variety of port orderings. For more information on these functions, see the corresponding reference pages.

### Convert S-Parameters

In this example, use the toolbox to import 4-port single-ended S-parameter data from a file, convert the data to 2-port differential S-parameter data, and create a new `rfckt` object to store the converted data for analysis.

At the MATLAB prompt:

- 1 Type this command to import data from the file `default.s4p`:

```
SingleEnded4Port = read(rfdata.data, 'default.s4p');
```

- 2 Type this command to convert 4-port single-ended S-parameters to 2-port mixed-mode S-parameters:

```
DifferentialSPParams = s2sdd(SingleEnded4Port.S_Parameters);
```

---

**Note** The S-parameters that you specify as input to the `s2sdd` function are the ones the toolbox stores in the `S_Parameters` property of the `rfdata.data` object.

---

- 3 Type this command to create an `rfckt.passive` object that stores the 2-port differential S-parameters for simulation:

```
DifferentialCkt = rfckt.passive('NetworkData', ...  
    rfdata.network('Data', DifferentialSPParams, 'Freq', ...  
    SingleEnded4PortData.Freq));
```

## Extract M-Port S-Parameters from N-Port S-Parameters

After you import file data (as described in “Import Property Values from Data Files” on page 3-8), you can extract a set of data with a smaller number of ports by terminating one or more ports with a specified impedance.

This section contains the following topics:

- “Extract S-Parameters” on page 3-21
- “Extract S-Parameters From Imported File Data” on page 3-22

### Extract S-Parameters

To extract  $M$ -port S-parameters from  $N$ -port S-parameters, use the `snp2smp` function with the following syntax:

```
s_params_mp = snp2smp(s_params_np, z0, n2m_index, zt)
```

where

- `s_params_np` is an array of  $N$ -port S-parameters with a reference impedance  $z0$ .
- `s_params_mp` is an array of  $M$ -port S-parameters.
- `n2m_index` is a vector of length  $M$  specifying how the ports of the  $N$ -port S-parameters map to the ports of the  $M$ -port S-parameters. `n2m_index(i)` is the index of the port from `s_params_np` that is converted to the  $i$ th port of `s_params_mp`.
- `zt` is the termination impedance of the ports.

The following figure illustrates how to specify the ports for the output data and the termination of the remaining ports.

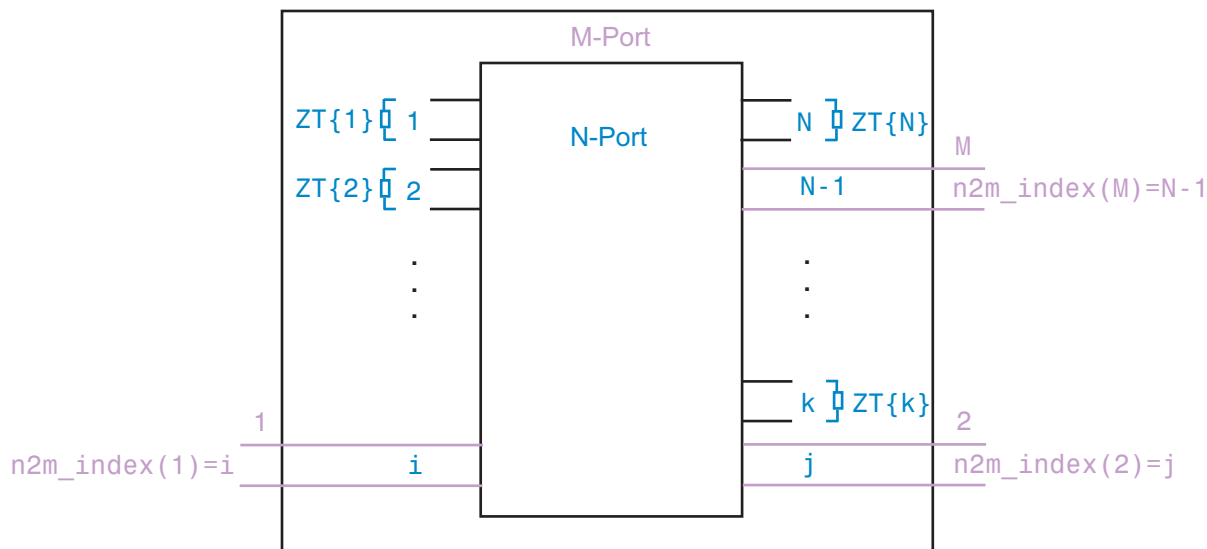

For more details about the arguments to this function, see the `snp2smp` reference page.

### Extract S-Parameters From Imported File Data

In this example, use the toolbox to import 16-port S-parameter data from a file, convert the data to 4-port S-parameter data by terminating the remaining ports, and create a new `rfckt` object to store the extracted data for analysis.

At the MATLAB prompt:

- 1 Type this command to import data from the file `default.s16p` into an `rfdata.data` object, `SingleEnded16PortData`:

```
SingleEnded16PortData = read(rfdata.data, 'default.s16p');
```

- 2 Type this command to convert 16-port S-parameters to 4-port S-parameters by using ports 1, 16, 2, and 15 as the first, second, third, and fourth ports, and terminating the remaining 12 ports with an impedance of 50 ohms:

```
N2M_index = [1 16 2 15];
FourPortSPParams = snp2smp(SingleEnded16PortData.S_Parameters, ...
```



```
SingleEnded16PortData.Z0, N2M_index, 50);
```

---

**Note** The S-parameters that you specify as input to the `snp2smp` function are the ones the toolbox stores in the `S_Parameters` property of the `rfdata.data` object.

---

- 3** Type this command to create an `rfckt.passive` object that stores the 4-port S-parameters for simulation:

```
FourPortChannel = rfckt.passive('NetworkData', ...
    rfdata.network('Data', FourPortSPParams, 'Freq', ...
    SingleEnded16PortData.Freq));
```

## Cascade N-Port S-Parameters

After you import file data (as described in “Import Property Values from Data Files” on page 3-8), you can cascade two or more networks of N-port S-parameters.

To cascade networks of N-port S-parameters, use the `cascadesparams` function with the following syntax:

```
s_params = cascadesparams(s1_params, s2_params, ..., sn_params, nconn)
```

where

- `s_params` is an array of cascaded S-parameters.
- `s1_params, s2_params, ..., sn_params` are arrays of input S-parameters.
- `nconn` is a positive scalar or a vector of size `n-1` specifying how many connections to make between the ports of the input S-parameters. `cascadesparams` connects the last port(s) of one network to the first port(s) of the next network.

For more details about the arguments to this function, see the `cascadesparams` reference page.

## Import and Cascade N-Port S-Parameters

In this example, use the toolbox to import 16-port and 4-port S-parameter file data and cascade the two S-parameter networks by connecting the last three ports of the 16-port network to the first three ports of the 4-port network. Then, create a new `rfckt` object to store the resulting network for analysis.

At the MATLAB prompt:

- 1 Type these commands to import data from the files `default.s16p` and `default.s4p`, and create the 16- and 4-port networks of S-parameters:

```
S_16Port = read(rfdata.data, 'default.s16p');  
S_4Port = read(rfdata.data, 'default.s4p');  
freq = [2e9 2.1e9];  
analyze(S_16Port, freq);  
analyze(S_4Port, freq);  
sparams_16p = S_16Port.S_Parameters;  
sparams_4p = S_4Port.S_Parameters;
```

- 2 Type this command to cascade 16-port S-parameters and 4-port S-parameters by connecting ports 14, 15, and 16 of the 16-port network to ports 1, 2, and 3 of the 4-port network:

```
sparams_cascaded = cascadesparams(sparams_16p, sparams_4p, 3)
```

`cascadesparams` creates a 14-port network. Ports 1–13 are the first 13 ports of the 16-port network. Port 14 is the fourth port of the 4-port network.

- 3 Type this command to create an `rfckt.passive` object that stores the 14-port S-parameters for simulation:

```
Ckt14 = rfckt.passive('NetworkData', ...  
    rfdata.network('Data', sparams_cascaded, 'Freq', ...  
    freq));
```

For more examples of how to use this function, see the `cascadesparams` reference page.

## Analyze and Plot RF Components

### In this section...

“Analyze Networks in the Frequency Domain” on page 3-25

“Visualize Component and Network Data” on page 3-26

“Compute and Plot Time-Domain Specifications” on page 3-35

### Analyze Networks in the Frequency Domain

RF Toolbox software lets you analyze RF components and networks in the frequency domain. You use the `analyze` method to analyze a circuit object over a specified set of frequencies.

For example, to analyze a coaxial transmission line from 1 GHz to 2.9 GHz in increments of 10 MHz:

```
ckt = rfckt.coaxial;  
f = [1.0e9:1e7:2.9e9];  
analyze(ckt,f);
```

---

**Note** For all circuits objects except those that contain data from a file, you must perform a frequency-domain analysis with the `analyze` method before visualizing component and network data. For circuits that contain data from a file, the toolbox performs a frequency-domain analysis when you use the `read` method to import the data.

---

When you analyze a circuit object, the toolbox computes the circuit network parameters, noise figure values, and output third-order intercept point (OIP3) values at the specified frequencies and stores the result of the analysis in the object's `AnalyzedResult` property.

For more information, see the `analyze` reference page or the circuit object reference page.

## Visualize Component and Network Data

The toolbox lets you validate the behavior of circuit objects that represent RF components and networks by plotting the following data:

- Large- and small-signal S-parameters
- Noise figure
- Output third-order intercept point
- Power data
- Phase noise
- Voltage standing-wave ratio
- Power gain
- Group delay
- Reflection coefficients
- Stability data
- Transfer function

The following table summarizes the available plots and charts, along with the methods you can use to create each one and a description of its contents.

Plot Type	Methods	Plot Contents
Rectangular Plot	plot plotyy loglog semilogx semilogy	Parameters as a function of frequency or, where applicable, operating condition. The available parameters include: <ul style="list-style-type: none"> <li>• S-parameters</li> <li>• Noise figure</li> <li>• Voltage standing-wave ratio (VSWR)</li> <li>• OIP3</li> </ul>
Budget Plot (3-D)	plot	Parameters as a function of frequency for each component

Plot Type	Methods	Plot Contents
		in a cascade, where the curve for a given component represents the cumulative contribution of each RF component up to and including the parameter value of that component.
Mixer Spur Plot	plot	Mixer spur power as a function of frequency for an <code>rfckt.mixer</code> object or an <code>rfckt.cascade</code> object that contains a mixer.
Polar Plot	polar	Magnitude and phase of S-parameters as a function of frequency.
Smith Chart	smith	Real and imaginary parts of S-parameters as a function of frequency, used for analyzing the reflections caused by impedance mismatch.

For each plot you create, you choose a parameter to plot and, optionally, a format in which to plot that parameter. The plot format defines how the toolbox displays the data on the plot. The available formats vary with the data you select to plot. The data you can plot depends on the type of plot you create.

---

**Note** You can use the `listparam` method to list the parameters of a specified circuit object that are available for plotting. You can use the `listformat` method to list the available formats for a specified circuit object parameter.

---

The following topics describe the available plots:

- “Rectangular” on page 3-28
- “Budget” on page 3-28

- “Mixer Spur” on page 3-31
- “Polar Plots and Smith Charts” on page 3-34

## Rectangular

You can plot any parameters that are relevant to your object on a rectangular plot. You can plot parameters as a function of frequency for any object. When you import object data from a .p2d or .s2d file, you can also plot parameters as a function of any operating condition from the file that has numeric values, such as bias. In addition, when you import object data from a .p2d file, you can plot large-signal S-parameters as a function of input power or as a function of frequency. These parameters are denoted LS11, LS12, LS21, and LS22.

The following table summarizes the methods that are available in the toolbox for creating rectangular plots and describes the uses of each one. For more information on a particular type of plot, follow the link in the table to the documentation for that method.

Method	Description
plot	Plot of one or more object parameters
plotyy	Plot of one or more object parameters with y-axes on both the left and right sides
semilogx	Plot of one or more object parameters using a log scale for the X-axis
semilogy	Plot of one or more object parameters using a log scale for the Y-axis
loglog	Plot of one or more object parameters using a log-log scale

## Budget

You use the link budget plot to understand the individual contribution of each component to a plotted parameter value in a cascaded network with multiple components.

The budget plot is a three-dimensional plot that shows one or more curves of parameter values as a function of frequency, ordered by the circuit index of the cascaded network.

Consider the following cascaded network:

```
casc = rfckt.cascade('Ckts',...  
                  {rfckt.amplifier,rfckt.lcbandpasspi,rfckt.txline})
```

The following figure shows how the circuit index is assigned to each component in the cascade, based on its sequential position in the network.

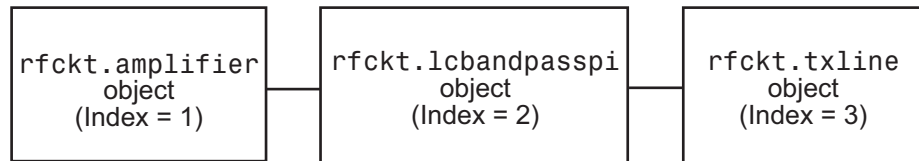

You create a budget plot for this cascade using the `plot` method with the second argument set to `'budget'`, as shown in the following command:

```
plot(casc, 'budget', 's21')
```

A curve on the link budget plot for each circuit index represents the contributions to the parameter value of the RF components up to that index. The following figure shows the budget plot.

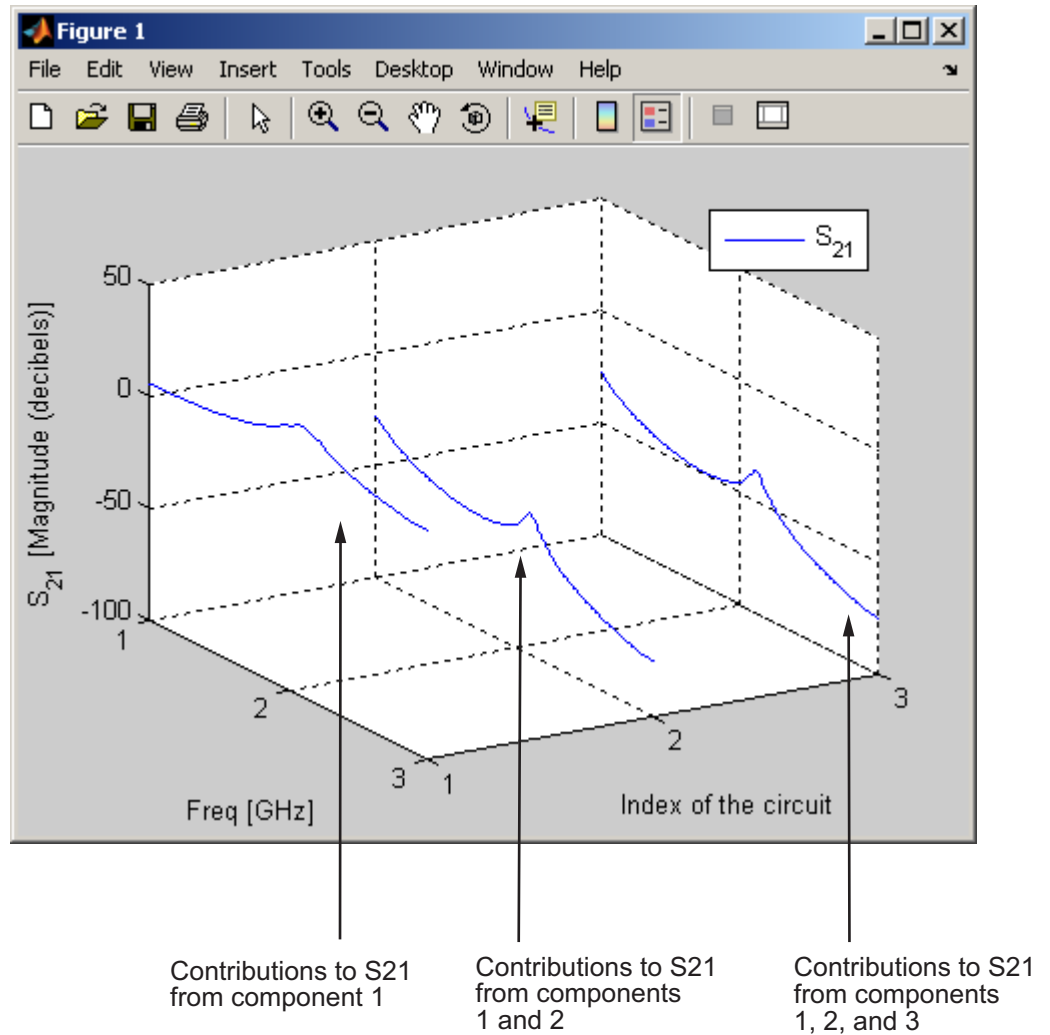

#### Budget Plot

If you specify two or more parameters, the toolbox puts the parameters in a single plot. You can only specify a single format for all the parameters.



## Mixer Spur

You use the mixer spur plot to understand how mixer nonlinearities affect output power at the desired mixer output frequency and at the intermodulation products that occur at the following frequencies:

$$f_{out} = N * f_{in} + M * f_{LO}$$

where

- $f_{in}$  is the input frequency.
- $f_{LO}$  is the local oscillator frequency.
- N and M are integers.

The toolbox calculates the output power from the mixer intermodulation table (IMT). These tables are described in detail in the Visualizing Mixer Spurs example.

The mixer spur plot shows power as a function of frequency for an `rfckt.mixer` object or an `rfckt.cascade` object that contains a mixer. By default, the plot is three-dimensional and shows a stem plot of power as a function of frequency, ordered by the circuit index of the object. You can create a two-dimensional stem plot of power as a function of frequency for a single circuit index by specifying the index in the mixer spur plot command.

Consider the following cascaded network:

```
FirstCkt = rfckt.amplifier('NetworkData', ...
    rfdata.network('Type', 'S', 'Freq', 2.1e9, ...
    'Data', [0,0;10,0]), 'NoiseData', 0, 'NonlinearData', inf);
SecondCkt = read(rfckt.mixer, 'samplespur1.s2d');
ThirdCkt = rfckt.lcbandpass('L', [97.21 3.66 97.21]*1e-9, ...
    'C', [1.63 43.25 1.63]*1.0e-12);
CascadedCkt = rfckt.cascade('Ckts', ...
    {FirstCkt, SecondCkt, ThirdCkt});
```

The following figure shows how the circuit index is assigned to the components in the cascade, based on its sequential position in the network.

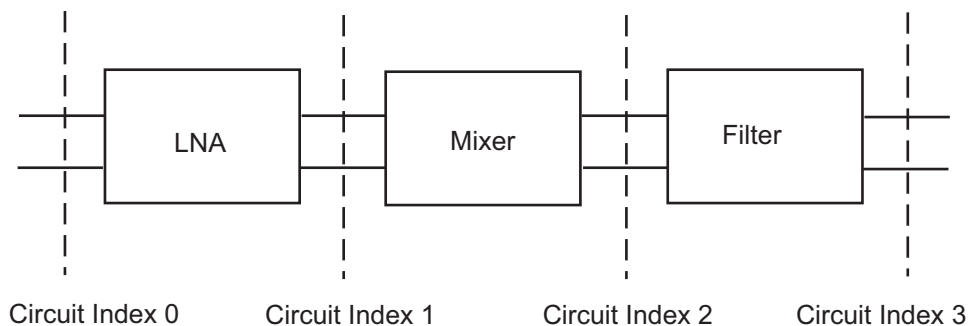

- Circuit index 0 corresponds to the cascade input.
- Circuit index 1 corresponds to the LNA output.
- Circuit index 2 corresponds to the mixer output.
- Circuit index 3 corresponds to the filter output.

You create a spur plot for this cascade using the `plot` method with the second argument set to `'mixerspur'`, as shown in the following command:

```
plot(CascadedCkt, 'mixerspur')
```

Within the three dimensional plot, the stem plot for each circuit index represents the power at that circuit index. The following figure shows the mixer spur plot.

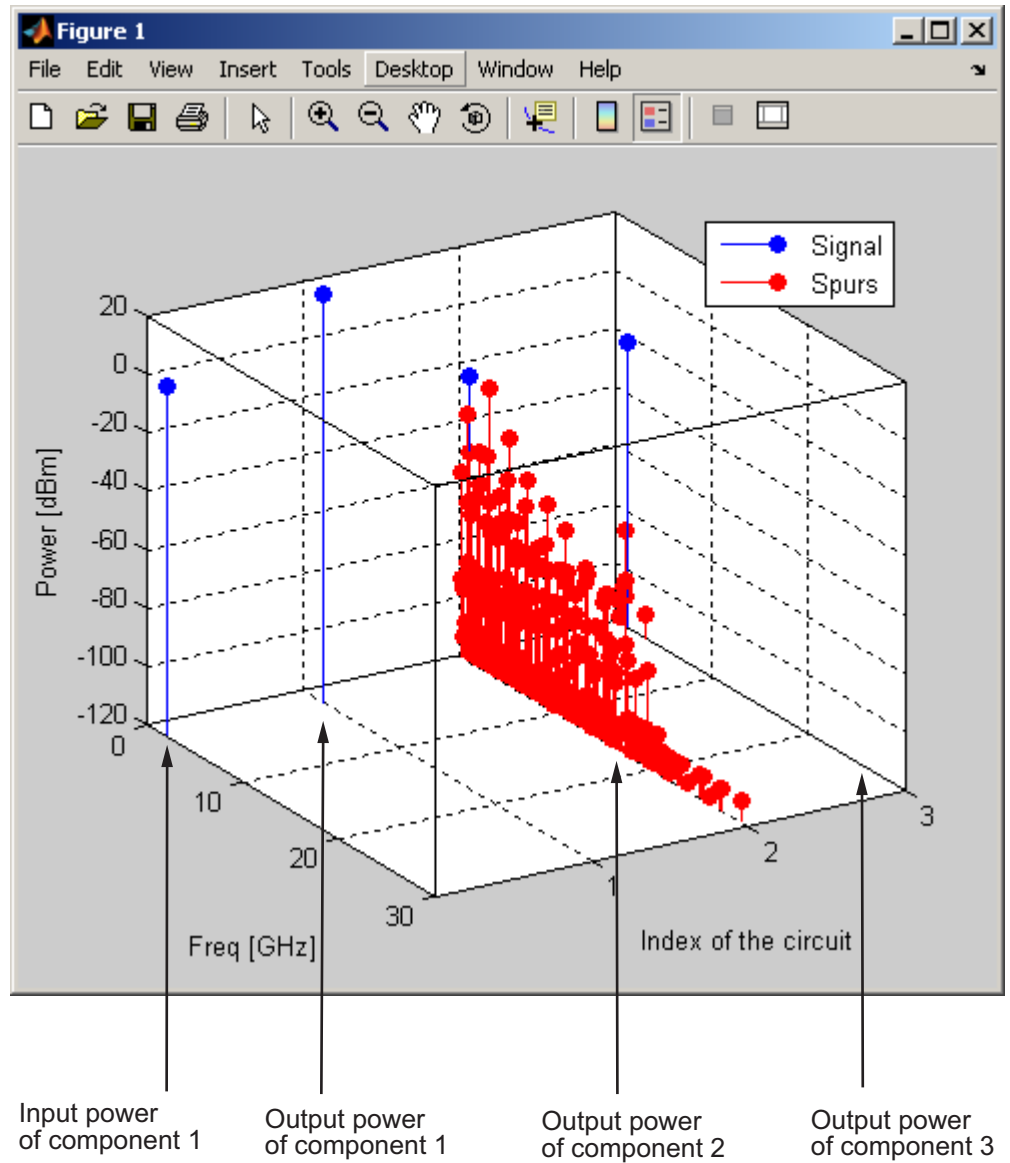

### Mixer Spur Plot

For more information on mixer spur plots, see the [plot reference page](#).

### Polar Plots and Smith Charts

You can use the toolbox to generate Polar plots and Smith Charts. If you specify two or more parameters, the toolbox puts the parameters in a single plot.

The following table describes the Polar plot and Smith Chart options, as well as the available parameters.

---

**Note** LS11, LS12, LS21, and LS22 are large-signal S-parameters. You can plot these parameters as a function of input power or as a function of frequency.

---

Plot Type	Method	Parameter
Polar plane	polar	S11, S12, S21, S22 LS11, LS12, LS21, LS22 (Objects with data from a P2D file only)
Z Smith chart	smith with type argument set to 'z'	S11, S22 LS11, LS22 (Objects with data from a P2D file only)
Y Smith chart	smith with type argument set to 'y'	S11, S22 LS11, LS22 (Objects with data from a P2D file only)
ZY Smith chart	smith with type argument set to 'zy'	S11, S22 LS11, LS22 (Objects with data from a P2D file only)

By default, the toolbox plots the parameter as a function of frequency. When you import block data from a .p2d or .s2d file, you can also plot parameters as a function of any operating condition from the file that has numeric values, such as bias.

---

**Note** The `circle` method lets you place circles on a Smith Chart to depict stability regions and display constant gain, noise figure, reflection and immittance circles. For more information about this method, see the `circle` reference page or the two-part RF Toolbox example about designing matching networks.

---

For more information on a particular type of plot, follow the link in the table to the documentation for that method.

## Compute and Plot Time-Domain Specifications

The toolbox lets you compute and plot time-domain characteristics for RF components.

This section contains the following topics:

- “Compute the Network Transfer Function” on page 3-35
- “Fit a Model Object to Circuit Object Data” on page 3-36
- “Compute and Plotting the Time-Domain Response” on page 3-37

### Compute the Network Transfer Function

You use the `s2tf` function to convert 2-port S-parameters to a transfer function. The function returns a vector of transfer function values that represent the normalized voltage gain of a 2-port network.

The following code illustrates how to read file data into a passive circuit object, extract the 2-port S-parameters from the object and compute the transfer function of the data at the frequencies for which the data is specified. `z0` is the reference impedance of the S-parameters, `zs` is the source impedance, and `z1` is the load impedance. See the `s2tf` reference page for more information on how these impedances are used to define the gain.

```
PassiveCkt = rfckt.passive('File','passive.s2p')
z0=50; zs=50; z1=50;
[SParams, Freq] = extract(PassiveCkt, 'S Parameters', z0);
TransFunc = s2tf(SParams, z0, zs, z1);
```

#### Fit a Model Object to Circuit Object Data

You use the `rationalfit` function to fit a rational function to the transfer function of a passive component. The `rationalfit` function returns an `rfmodel` object that represents the transfer function analytically.

The following code illustrates how to use the `rationalfit` function to create an `rfmodel.rational` object that contains a rational function model of the transfer function that you created in the previous example.

```
RationalFunc = rationalfit(Freq, TransFunc)
```

To find out how many poles the toolbox used to represent the data, look at the length of the `A` vector of the `RationalFunc` model object.

```
nPoles = length(RationalFunc.A)
```

---

**Note** The number of poles is important if you plan to use the RF model object to create a model for use in another simulator, because a large number of poles can increase simulation time. For information on how to represent a component accurately using a minimum number of poles, see “Represent a Circuit Object with a Model Object” on page 4-5.

---

See the `rationalfit` reference page for more information.

Use the `freqresp` method to compute the frequency response of the fitted data. To validate the model fit, plot the transfer function of the original data and the frequency response of the fitted data.

```
Resp = freqresp(RationalFunc, Freq);  
plot(Freq, 20*log10(abs(TransFunc)), 'r', ...  
      Freq, 20*log10(abs(Resp)), 'b--');  
ylabel('Magnitude of H(s) (decibels)');  
xlabel('Frequency (Hz)');  
legend('Original', 'Fitting result');  
title(['Rational fitting with ', int2str(nPoles), ' poles']);
```

## Compute and Plotting the Time-Domain Response

You use the `timeresp` method to compute the time-domain response of the transfer function that `RationalFunc` represents.

The following code illustrates how to create a random input signal, compute the time-domain response of `RationalFunc` to the input signal, and plot the results.

```
SampleTime=1e-11;
NumberOfSamples=4750;
OverSamplingFactor = 25;
InputTime = double((1:NumberOfSamples)')*SampleTime;
InputSignal = ...
    sign(randn(1, ceil(NumberOfSamples/OverSamplingFactor)));
InputSignal = repmat(InputSignal, [OverSamplingFactor, 1]);
InputSignal = InputSignal(:);

[tresp,t]=timeresp(RationalFunc,InputSignal,SampleTime);
plot(t*1e9,tresp);
title('Fitting Time-Domain Response', 'fonts', 12);
ylabel('Response to Random Input Signal');
xlabel('Time (ns)');
```

For more information about computing the time response of a model object, see the `timeresp` reference page.

## Export Component Data to a File

In this section...
“Available Export Formats” on page 3-38
“How to Export Object Data” on page 3-38
“Export Object Data” on page 3-39

### Available Export Formats

RF Toolbox software lets you export data from any `rfckt` object or from an `rfdata.data` object to industry-standard data files and MathWorks AMP files. This export capability lets you store data for use in other simulations.

---

**Note** The toolbox also lets you export data from an `rfmodel` object to a Verilog-A file. For information on how to do this, see “Export a Verilog-A Model” on page 4-5.

---

You can export data to the following file formats:

- Industry-standard file formats — Touchstone SNP, YNP, ZNP, HNP, and GNP formats specify the network parameters and noise information for measured and simulated data.

For more information about Touchstone files, see [www.vhdl.org/pub/ibis/connector/touchstone\\_spec11.pdf](http://www.vhdl.org/pub/ibis/connector/touchstone_spec11.pdf).

- MathWorks amplifier (AMP) file format — Specifies amplifier network parameters, output power versus input power, noise data and third-order intercept point.

For more information about `.amp` files, see Appendix A, “AMP File Format”.

### How to Export Object Data

To export data from a circuit or data object, use a `write` command of the form

```
status = write(obj, 'filename');
```



where

- `status` is a return value that indicates whether the write operation was successful.
- `obj` is the handle of the circuit or `rfdata.data` object.
- `filename` is the name of the file that contains the data.

For example,

```
status = write(rfckt.amplifier, 'myamp.amp');
```

exports data from an `rfckt.amplifier` object to the file `myamp.amp`.

## Export Object Data

In this example, use the toolbox to create a vector of S-parameter data, store it in an `rfdata.data` object, and export it to a Touchstone file.

At the MATLAB prompt:

- 1 Type the following to create a vector, `s_vec`, of S-parameter values at three frequency values:

```
s_vec(:,:,1) = ...
    [-0.724725-0.481324i, -0.685727+1.782660i; ...
     0.000000+0.000000i, -0.074122-0.321568i];
s_vec(:,:,2) = ...
    [-0.731774-0.471453i, -0.655990+1.798041i; ...
     0.001399+0.000463i, -0.076091-0.319025i];
s_vec(:,:,3) = ...
    [-0.738760-0.461585i, -0.626185+1.813092i; ...
     0.002733+0.000887i, -0.077999-0.316488i];
```

- 2 Type the following to create an `rfdata.data` object called `txdata` with the default property values:

```
txdata = rfdata.data;
```

- 3 Type the following to set the S-parameter values of `txdata` to the values you specified in `s_vec`:

```
txdata.S_Parameters = s_vec;
```

- 4** Type the following to set the frequency values of txdata to [1e9 2e9 3e9]:

```
txdata.Freq=1e9*[1 2 3];
```

- 5** Type the following to export the data in txdata to a Touchstone file called test.s2p:

```
write(txdata, 'test')
```

## Basic Operations with RF Objects

### In this section...

“Read and Analyze RF Data from a Touchstone Data File” on page 3-41

“De-Embed S-Parameters” on page 3-43

### Read and Analyze RF Data from a Touchstone Data File

In this example, you create an `rfdata.data` object by reading the S-parameters of a 2-port passive network stored in the Touchstone format data file, `passive.s2p`.

- 1 Read S-parameter data from a data file.** Use the RF Toolbox `read` command to read the Touchstone data file, `passive.s2p`. This file contains 50-ohm S-parameters at frequencies ranging from 315 kHz to 6 GHz. The `read` command creates an `rfdata.data` object, `data`, and stores data from the file in the object's properties.

```
data = read(rfdata.data, 'passive.s2p');
```

- 2 Extract the network parameters from the data object.** Use the `extract` command to convert the 50-ohm S-parameters in the `rfdata.data` object, `data`, to 75-ohm S-parameters and save them in the variable `s_params`. You also use the command to extract the Y-parameters from the `rfdata.data` object and save them in the variable `y_params`.

```
freq = data.Freq;  
s_params = extract(data, 'S_PARAMETERS', 75);  
y_params = extract(data, 'Y_PARAMETERS');
```

**3 Plot the  $S_{11}$  parameters.** Use the `smithchart` command to plot the 75-ohm  $S_{11}$  parameters on a Smith Chart:

```
s11 = s_params(1,1,:);
smithchart(s11(:));
```

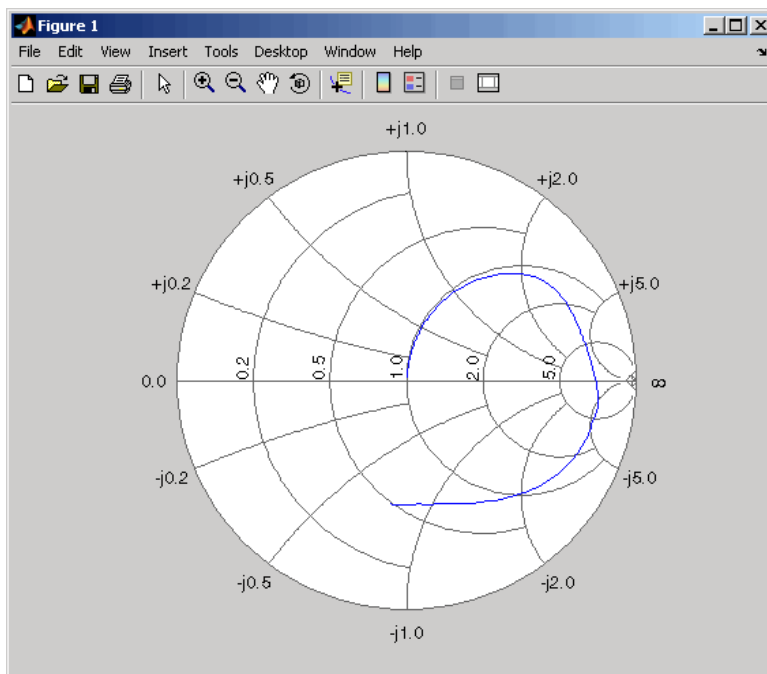

**4 View the 75-ohm S-parameters and Y-parameters at 6 GHz.** Type the following set of commands at the MATLAB prompt to display the four 75-ohm S-parameter values and the four Y-parameter values at 6 GHz.

```
f = freq(end)
s = s_params(:,:,end)
y = y_params(:,:,end)
```

The toolbox displays the following output:

```
f =
    6.0000e+009

s =
   -0.0764 - 0.5401i    0.6087 - 0.3018i
    0.6094 - 0.3020i   -0.1211 - 0.5223i

y =
    0.0210 + 0.0252i   -0.0215 - 0.0184i
   -0.0215 - 0.0185i    0.0224 + 0.0266i
```

For more information, see the `rfddata.data`, `read`, and `extract` reference pages.

## De-Embed S-Parameters

The Touchstone data file `samplebjt2.s2p` contains S-parameter data collected from a bipolar transistor in a test fixture. The input of the fixture has a bond wire connected to a bond pad. The output of the fixture has a bond pad connected to a bond wire.

The configuration of the bipolar transistor, which is the device under test (DUT), and the fixture is shown in the following figure.

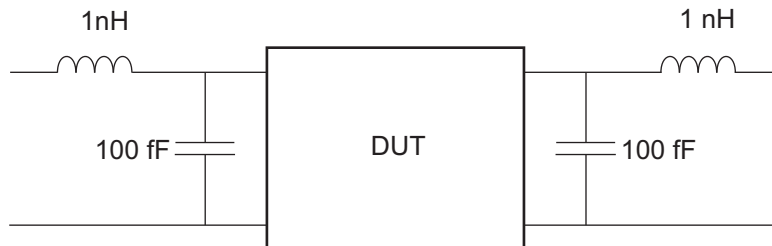

In this example, you remove the effects of the fixture and extract the S-parameters of the DUT.

- 1 Create RF objects.** Create a data object for the measured S-parameters by reading the Touchstone data file `samplebjt2.s2p`. Then, create two more circuit objects, one each for the input pad and output pad.

```
measured_data = read(rfdata.data,'samplebjt2.s2p');
input_pad = rfckt.cascade('Ckts',...
    {rfckt.seriesrlc('L',1e-9), ...
    rfckt.shuntrlc('C',100e-15)});    % L=1 nH, C=100 fF
output_pad = rfckt.cascade('Ckts',...
    {rfckt.shuntrlc('C',100e-15),...
    rfckt.seriesrlc('L',1e-9)});    % L=1 nH, C=100 fF
```

- 2 Analyze the input pad and output pad circuit objects.** Analyze the circuit objects at the frequencies at which the S-parameters are measured.

```
freq = measured_data.Freq;
analyze(input_pad,freq);
analyze(output_pad,freq);
```

- 3 De-embed the S-parameters.** Extract the S-parameters of the DUT from the measured S-parameters by removing the effects of the input and output pads.

```
z0 = measured_data.Z0;

input_pad_sparams = extract(input_pad.AnalyzedResult,...
    'S_Parameters',z0);
output_pad_sparams = extract(output_pad.AnalyzedResult,...
    'S_Parameters',z0);

de_embedded_sparams = ...
deembedsparams(measured_data.S_Parameters,...
    input_pad_sparams, output_pad_sparams);
```

- 4 Create a data object for the de-embedded S-parameters.** In a later step, you use this data object to plot the de-embedded S-parameters.

```
de_embedded_data = rfdata.data('Z0',z0,...
    'S_Parameters',de_embedded_sparams,...
    'Freq',freq);
```

**5 Plot the measured and de-embedded  $S_{11}$  parameters.** Type the following set of commands at the MATLAB prompt to plot both the measured and the de-embedded  $S_{11}$  parameters on a Z Smith Chart:

```
hold off;
h = smith(measured_data,'S11');
set(h, 'Color', [1 0 0]);
hold on
i = smith(de_embedded_data,'S11');
set(i,'Color', [0 0 1],'LineStyle',':');
l = legend;
legend(l, {'Measured S_{11}', 'De-embedded S_{11}'});
legend show;
```

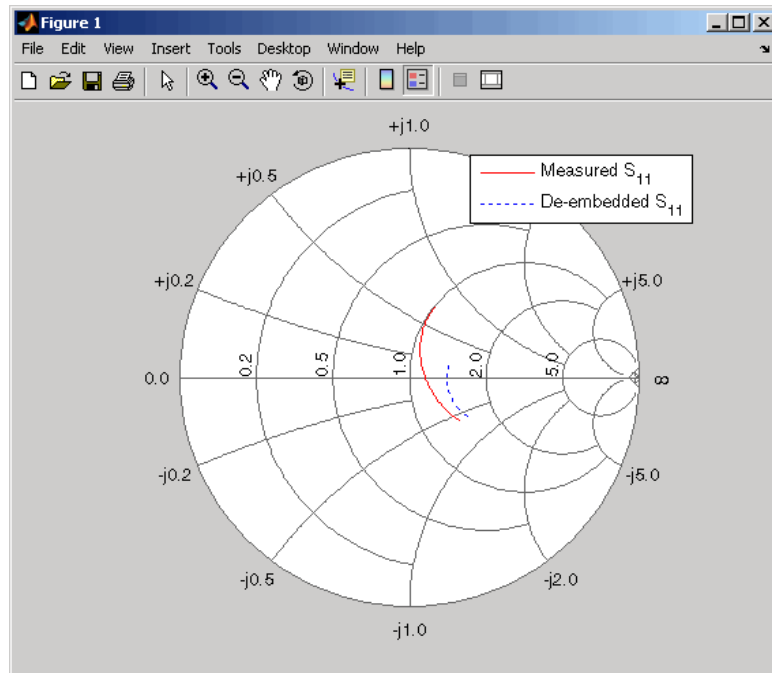

- 6 Plot the measured and de-embedded  $S_{22}$  parameters.** Type the following set of commands at the MATLAB prompt to plot the measured and the de-embedded  $S_{22}$  parameters on a Z Smith Chart:

```
figure;
hold off;
h = smith(measured_data,'S22');
set(h, 'Color', [1 0 0]);
hold on
i = smith(de_embedded_data,'S22');
set(i,'Color', [0 0 1],'LineStyle',':');
l = legend;
legend(l, {'Measured S_{22}', 'De-embedded S_{22}'});
legend show;
```

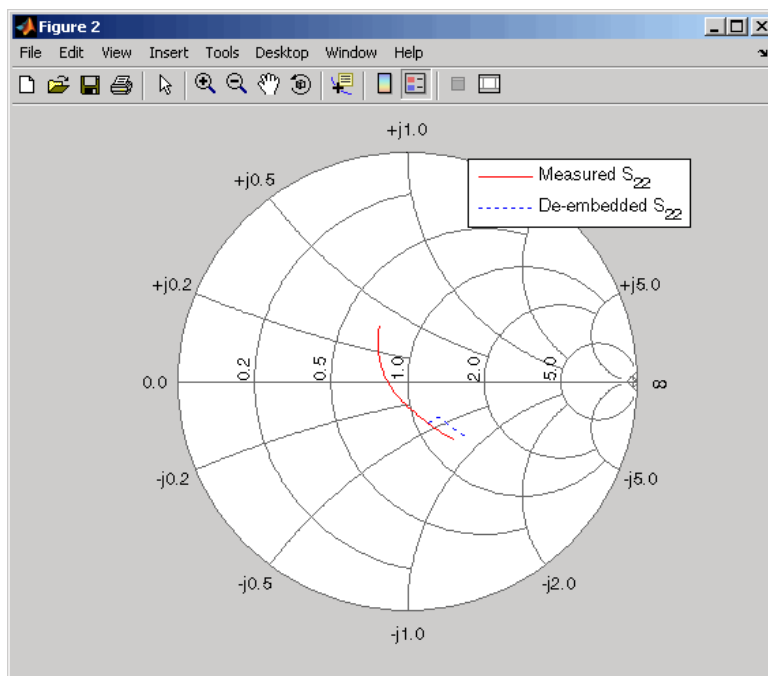



**7 Plot the measured and de-embedded  $S_{21}$  parameters.** Type the following set of commands at the MATLAB prompt to plot the measured and the de-embedded  $S_{21}$  parameters, in decibels, on an X-Y plane:

```
figure
hold off;
h = plot(measured_data,'S21', 'db');
set(h, 'Color', [1 0 0]);
hold on
i = plot(de_embedded_data,'S21','db');
set(i,'Color', [0 0 1],'LineStyle',':');
l = legend;
legend(l, {'Measured S_{21}', 'De-embedded S_{21}'});
legend show;
hold off;
```

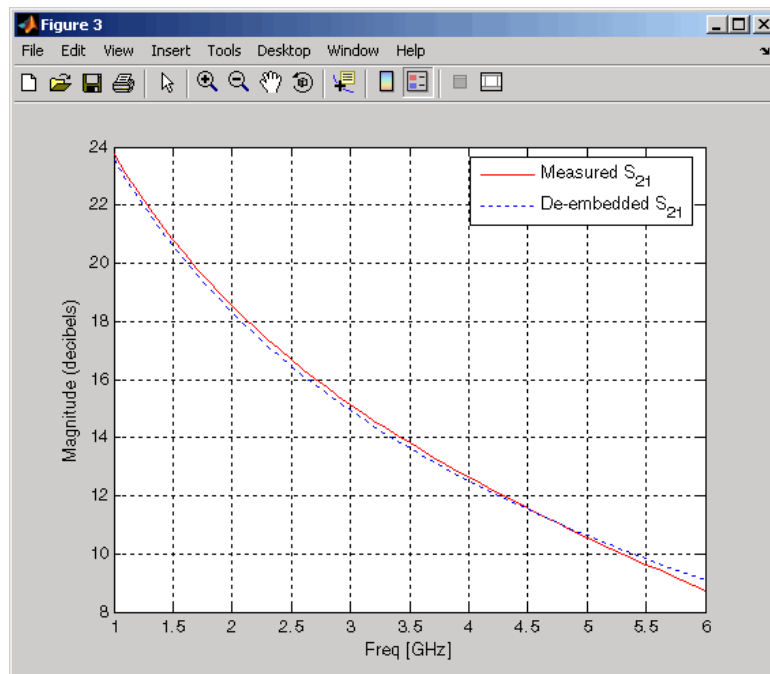



# Export Verilog-A Models

---

- “Model RF Objects Using Verilog-A” on page 4-2
- “Export a Verilog-A Model” on page 4-5

## Model RF Objects Using Verilog-A

In this section...
“Overview” on page 4-2
“Behavioral Modeling Using Verilog-A” on page 4-2
“Supported Verilog-A Models” on page 4-3

### Overview

Verilog-A is a language for modeling the high-level behavior of analog components and networks. Verilog-A describes components mathematically, for fast and accurate simulation.

RF Toolbox software lets you export a Verilog-A description of your circuit. You can create a Verilog-A model of any passive RF component or network and use it as a behavioral model for transient analysis in a third-party circuit simulator. This capability is useful in signal integrity engineering. For example, you can import the measured four-port S-parameters of a backplane into the toolbox, export a Verilog-A model of the backplane to a circuit simulator, and use the model to determine the performance of your driver and receiver circuitry when they are communicating across the backplane.

### Behavioral Modeling Using Verilog-A

The Verilog-A language is a high-level language that uses modules to describe the structure and behavior of analog systems and their components. A *module* is a programming building block that forms an executable specification of the system.

Verilog-A uses modules to capture high-level analog behavior of components and systems. Modules describe circuit behavior in terms of

- Input and output nets characterized by predefined Verilog-A disciplines that describe the attributes of the nets.
- Equations and module parameters that define the relationship between the input and output nets mathematically.

When you create a Verilog-A model of your circuit, the toolbox writes a Verilog-A module that specifies circuit's input and output nets and the mathematical equations that describe how the circuit operates on the input to produce the output.

For more information on the Verilog-A language, see the Verilog-A Reference Manual.

## Supported Verilog-A Models

RF Toolbox software lets you export a Verilog-A model of an `rfmodel` object. The toolbox provides one `rfmodel` object, `rfmodel.rational`, that you can use to represent any RF component or network for export to Verilog-A.

The `rfmodel.rational` object represents components as rational functions in pole-residue form, as described in the `rfmodel.rational` reference page. This representation can include complex poles and residues, which occur in complex-conjugate pairs.

The toolbox implements each `rfmodel.rational` object as a series of Laplace Transform S-domain filters in Verilog-A using the numerator-denominator form of the Laplace transform filter:

$$H(s) = \frac{\sum_{k=0}^M n_k s^k}{\sum_{k=0}^N d_k s^k}$$

where

- $M$  is the order of the numerator polynomial.
- $N$  is the order of the denominator polynomial.
- $n_k$  is the coefficient of the  $k$ th power of  $s$  in the numerator.
- $d_k$  is the coefficient of the  $k$ th power of  $s$  in the denominator.

The number of poles in the rational function is related to the number of Laplace transform filters in the Verilog-A module. However, there is

not a one-to-one correspondence between the two. The difference arises because the toolbox combines each pair of complex-conjugate poles and the corresponding residues in the rational function to form a Laplace transform numerator and denominator with real coefficients. the toolbox converts the real poles of the rational function directly to a Laplace transform filter in numerator-denominator form.

## Export a Verilog-A Model

### In this section...

“Represent a Circuit Object with a Model Object” on page 4-5

“Write a Verilog-A Module” on page 4-7

### Represent a Circuit Object with a Model Object

Before you can write a Verilog-A model of an RF circuit object, you need to create an `rfmodel.rational` object to represent the component.

There are two ways to create an RF model object:

- You can fit a rational function model to the component data using the `rationalfit` function.
- You can use the `rfmodel.rational` constructor to specify the pole-residue representation of the component directly.

This section discusses using a rational function model. For more information on using the constructor, see the `rfmodel.rational` reference page.

When you use the `rationalfit` function to create an `rfmodel.rational` object that represents an RF component, the arguments you specify affect how quickly the resulting Verilog-A model runs in a circuit simulator.

You can use the `rationalfit` function with only the two required arguments. The syntax is:

```
model_obj = rationalfit(freq,data)
```

where

- `model_obj` is a handle to the rational function model object.
- `freq` is a vector of frequency values that correspond to the data values.
- `data` is a vector that contains the data to fit.

For faster simulation, create a model object with the smallest number of poles required to accurately represent the component. To control the number of poles, use the syntax:

```
model_obj = rationalfit(freq,data,tol,weight,delayfactor)
```

where

- *tol* — the relative error-fitting tolerance, in decibels. Specify the largest acceptable tolerance for your application. Using tighter tolerance values may force the `rationalfit` function to add more poles to the model to achieve a better fit.
- *weight* — a vector that specifies the weighting of the fit at each frequency.
- *delayfactor* — a value that controls the amount of delay used to fit the data. Delay introduces a phase shift in the frequency domain that may require a large number of poles to fit using a rational function model. When you specify the delay factor, the `rationalfit` function represents the delay as an exponential phase shift. This phase shift allows the function to fit the data using fewer poles.

These arguments are described in detail in the `rationalfit` function reference page.

---

**Note** You can also specify the number of poles directly using the `npoles` argument. The model accuracy is not guaranteed with approach, so you should not specify `npoles` when accuracy is critical. For more information on the `npoles` argument, see the `rationalfit` reference page.

---

If you plan to integrate the Verilog-A module into a large design for simulation using detailed models, such as transistor-level circuit models, the simulation time consumed by a Verilog-A module may have a trivial impact on the overall simulation time. In this case, there is no reason to take the time to optimize the rational function model of the component.

For more information on the `rationalfit` function arguments, see the `rationalfit` reference page.



## Write a Verilog-A Module

You use the `writeva` method to create a Verilog-A module that describes the RF model object. This method writes the module to a specified file. Use the syntax:

```
status = writeva(model_obj, 'obj1', {'inp', 'inn'}, {'outp', 'outn'})
```

to write a Verilog-A module for the model object `model_obj` to the file `obj1.va`. The module has differential input nets, `inp` and `inn`, and differential output nets, `outp` and `outn`. The method returns `status`, a logical value of `true` if the operation is successful and `false` otherwise.

The `writeva` reference page describes the method arguments in detail.

An example of exporting a Verilog-A module appears in the RF Toolbox example, *Modeling a High-Speed Backplane (Part 5: Rational Function Model to a Verilog-A Module)*.



# RF Tool: An RF Analysis GUI

---

- “RF Tool” on page 5-2
- “Create and Import Circuits with RF Tool” on page 5-6
- “Modify Component Data in RF Tool” on page 5-19
- “Analyze Circuits Using RF Tool” on page 5-20
- “Export RF Objects from RF Tool” on page 5-23
- “Manage Circuits and Sessions in RF Tool” on page 5-27
- “Model an RF Network Using RF Tool” on page 5-31

## RF Tool

In this section...
“What Is RF Tool?” on page 5-2
“Open RF Tool” on page 5-2
“RF Tool Window” on page 5-3
“RF Tool Workflow” on page 5-5

### What Is RF Tool?

RF Tool is a GUI that provides a visual interface for creating and analyzing RF components and networks. You can use RF Tool as a convenient alternative to the command-line RF circuit design and analysis objects and methods that come with RF Toolbox software.

RF Tool provides the ability to

- Create and import circuits.
- Set circuit parameters.
- Analyze circuits.
- Display circuit S-parameters in tabular form and on X-Y plots, polar plots, and Smith Charts.
- Export circuit data to the MATLAB workspace and to data files.

### Open RF Tool

To open RF Tool, type the following at the MATLAB prompt:

```
rftool
```

For a description of the RF Tool GUI, see “RF Tool Window” on page 5-3. To learn how to create and import circuits, see “Create and Import Circuits with RF Tool” on page 5-6.

---

**Note** The work you do with this tool is organized into sessions. Each session is a collection of independent RF circuits, which can be RF components or RF networks. You can save sessions and then load them for later use. For more information, see “Working with RF Tool Sessions” on page 5-28.

---

## RF Tool Window

The RF Tool window consists of the following three panes:

- **RF Component List**

Shows the components and networks in the session. The top-level node is the session.

- **Component Parameters**

Displays options and settings pertaining to the node you selected in the **RF Component List** pane.

- **Analysis**

Displays options and settings pertaining to the circuit analysis and results display. After you analyze the circuit, this pane displays the analysis results and provides an interface for you to view the S-parameter data and modify the displayed plots.

The following figure shows the RF Tool window.

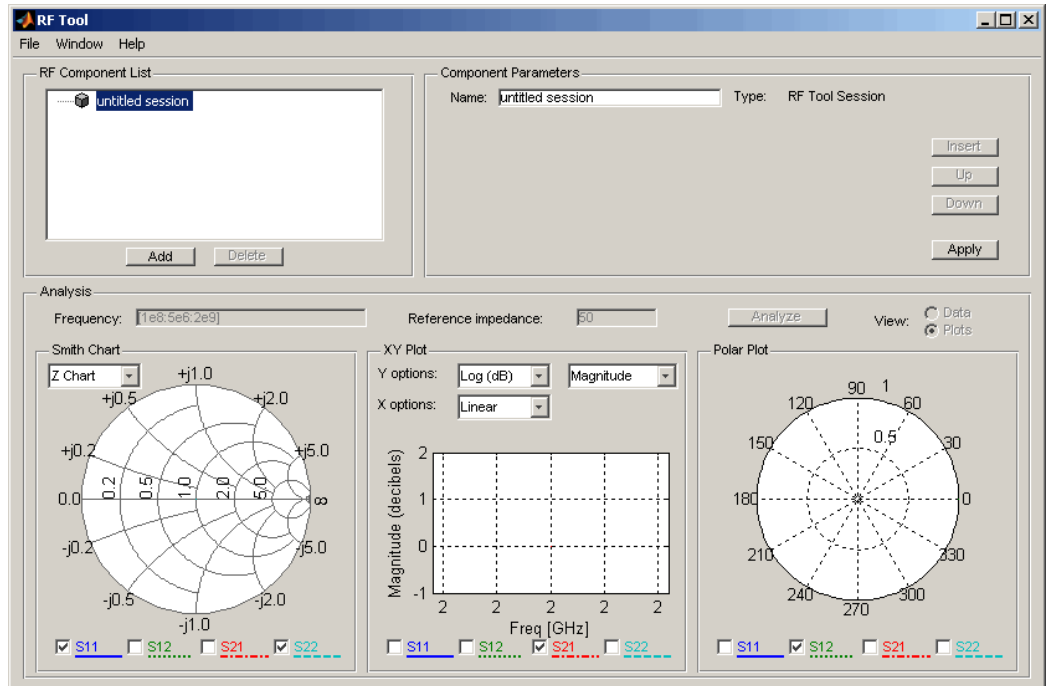

## RF Tool Workflow

When you analyze a circuit using the RF Tool GUI, your workflow might include the following tasks:

**1** Build the circuit by

- Creating RF components and networks.
- Importing components and networks from the MATLAB workspace or from a data file.

See “Create and Import Circuits with RF Tool” on page 5-6.

**2** Specify component data.

See “Modify Component Data in RF Tool” on page 5-19.

**3** Analyze the circuit.

See “Analyze Circuits Using RF Tool” on page 5-20.

**4** Export the circuit to the MATLAB workspace or to a file.

See “Export RF Objects from RF Tool” on page 5-23.

## Create and Import Circuits with RF Tool

In this section...
“Circuits in RF Tool” on page 5-6
“Create RF Components” on page 5-6
“Create RF Networks with RF Tool” on page 5-10
“Import RF Objects into RF Tool” on page 5-15

### Circuits in RF Tool

In RF Tool, you can create circuits that include RF components and RF networks. Networks can contain both components and other networks.

---

**Note** In the circuit object command line interface, you create networks by building components and then connecting them together to form a network. In contrast, you build networks in RF Tool by creating a network and then populating it with components.

---

### Create RF Components

This section contains the following topics:

- “Available RF Components” on page 5-7
- “Add an RF Component to a Session” on page 5-8



## Available RF Components

The following table lists the RF components you can create using RF Tool and the corresponding RF Toolbox object.

<b>RF Component</b>	<b>Corresponding RF Object</b>
Data File	<code>rfckt.datafile</code>
Delay Line	<code>rfckt.delay</code>
Coaxial Transmission Line	<code>rfckt.coaxial</code>
Coplanar Waveguide Transmission Line	<code>rfckt.cpw</code>
Microstrip Transmission Line	<code>rfckt.microstrip</code>
Parallel-Plate Transmission Line	<code>rfckt.parallelplate</code>
Transmission Line	<code>rfckt.txline</code>
Two-Wire Transmission Line	<code>rfckt.twowire</code>
Series RLC	<code>rfckt.seriesrlc</code>
Shunt RLC	<code>rfckt.shuntrlc</code>
LC Bandpass Pi	<code>rfckt.lcbandpasspi</code>
LC Bandpass Tee	<code>rfckt.lcbandpasstee</code>
LC Bandstop Pi	<code>rfckt.lcbandstoppi</code>
LC Bandstop Tee	<code>rfckt.lcbandstoptee</code>
LC Highpass Pi	<code>rfckt.lchighpasspi</code>
LC Highpass Tee	<code>rfckt.lchighpasstee</code>
LC Lowpass Pi	<code>rfckt.lclowpasspi</code>
LC Lowpass Tee	<code>rfckt.lclowpasstee</code>

## Add an RF Component to a Session

- 1 In the **RF Component List** pane, click **Add** to open the Create Network or Component dialog box.

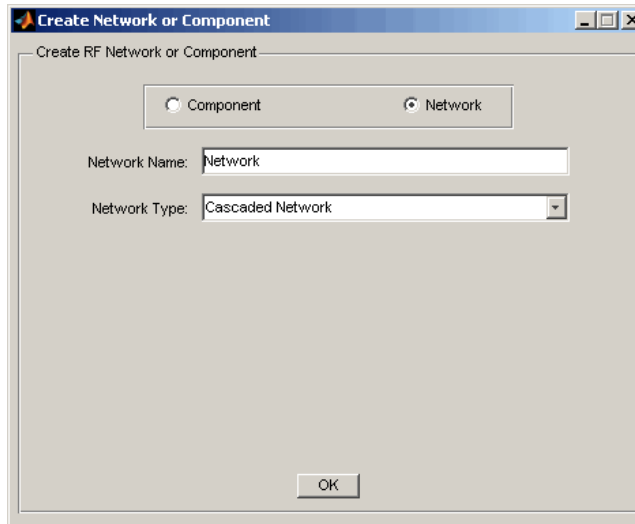

- 2 In the Create Network or Component dialog box, select **Component**.
- 3 In the **Component Name** field, enter a name for the component. This name is used to identify the component in the **RF Component List** pane. For example, Microstrip Component.

- 4 From the **Component Type** menu, select the type of RF component you want to create. For example, Microstrip Transmission Line.

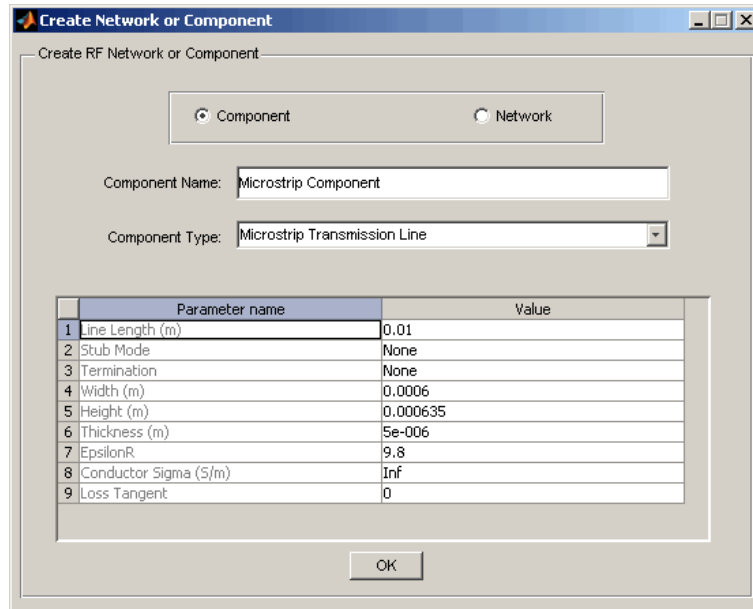

- 5 Adjust the parameter values as necessary.

---

**Note** You can accept the default values for some or all of the parameters and then change them later. For information on modifying the parameter values of an existing component, see “Modify Component Data in RF Tool” on page 5-19.

---

### 6 Click **OK**.

RF Tool adds the component to your session.

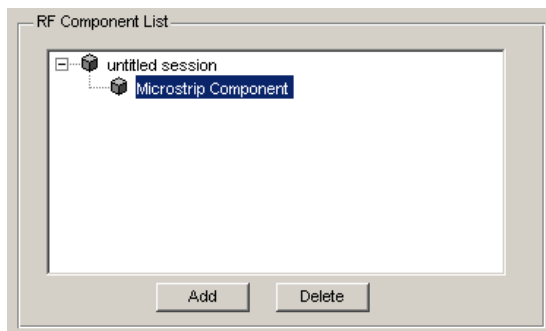

## Create RF Networks with RF Tool

You create an RF network in RF Tool by adding a network to the session and then adding components to the network.

This section contains the following topics:

- “Available RF Networks” on page 5-11
- “Add an RF Network to a Session” on page 5-11
- “Populate an RF Network” on page 5-13
- “Reorder Circuits Within a Network” on page 5-14

## Available RF Networks

The following table lists the RF networks you can create using RF Tool.

RF Network	Corresponding RF Toolbox Object
Cascaded Network	rfckt.cascade
Series Connected Network	rfckt.series
Parallel Connected Network	rfckt.parallel
Hybrid Connected Network	rfckt.hybrid
Inverse Hybrid Connected Network	rfckt.hybridg

## Add an RF Network to a Session

- 1 In the **RF Component List** pane, click **Add** to open the Create Network or Component dialog box.

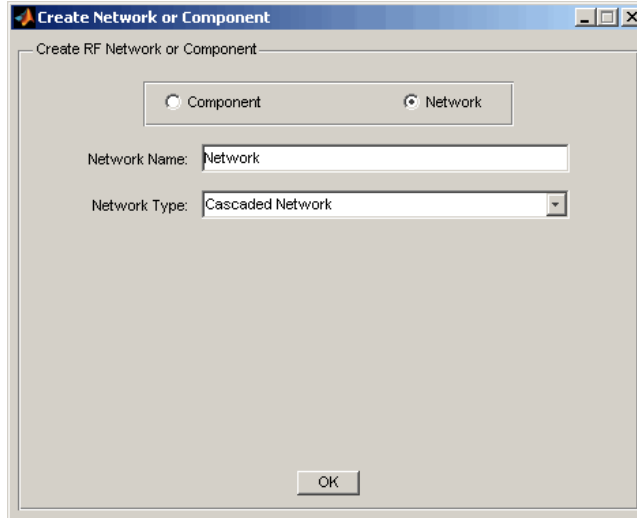

- 2 In the Create Network or Component dialog box, select the **Network** option button.

- 3** In the **Network Name** field, enter a name for the component. This name is used to identify the network in the **RF Component List** pane. For example, Series1.
- 4** From the **Network Type** menu, select the type of RF network you want to create. For example, Series Connected Network.

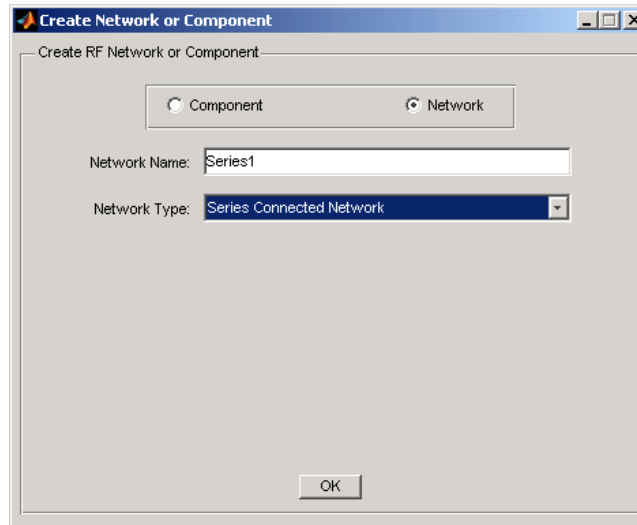

- 5** Click **OK**.

The RF Component List pane shows the new network.

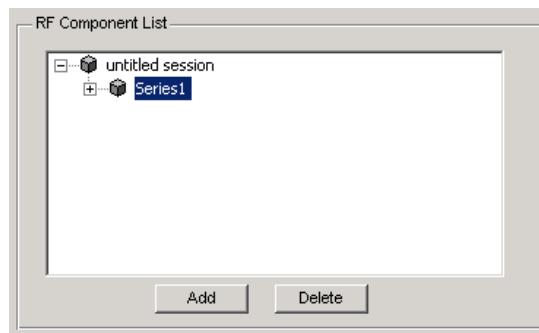

## Populate an RF Network

After you create a network using RF Tool, you must populate it with RF components and networks. You insert a component or network into a network in much the same way you add one to a session.

To populate an RF network:

- 1 In the **RF Component List** pane, select the network component you want to modify. Then, in the **Component Parameters** pane, click **Insert**.

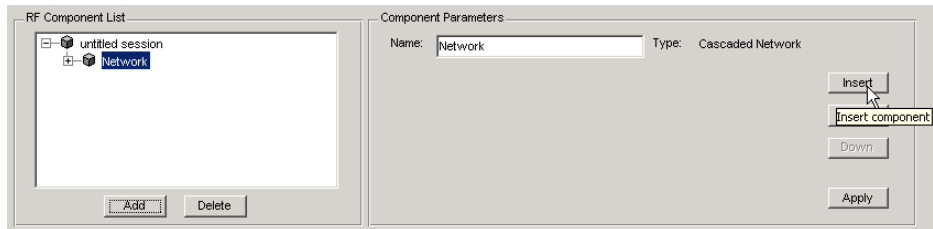

The Insert Component or Network dialog box appears.

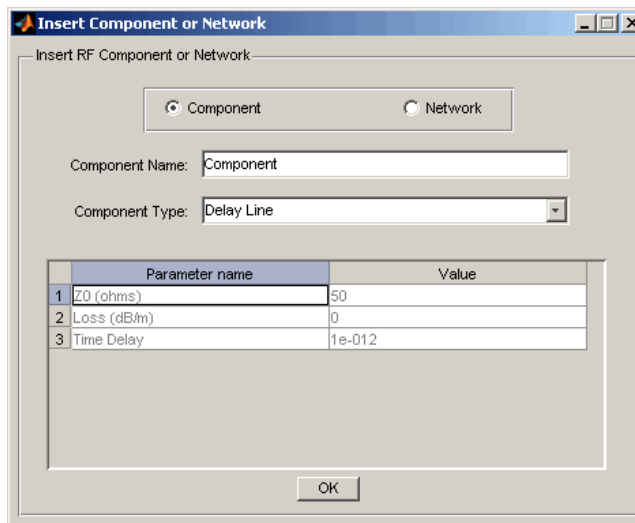

- 2 Click **Component** or **Network** in the Insert Component or Network dialog box to add either a component or a network.

Enter the component or network name, and select the appropriate type. If you are inserting a component, modify the parameter values as necessary. See “Add an RF Component to a Session” on page 5-8 or “Add an RF Network to a Session” on page 5-11 for details.

As you insert components and networks into a network, they are reflected in the **RF Component List** and **Component Parameters** panes. The figure below shows an example of a cascaded network that contains two components and a network. The subnetwork, in turn, contains two components.

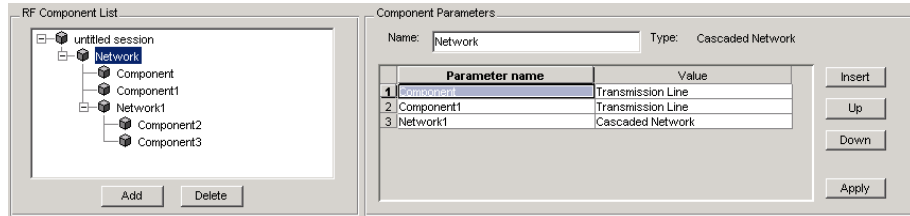

## Reorder Circuits Within a Network

To change the order of the components and networks within a network:

- 1 In the **RF Component List** pane, select the network whose circuits you want to reorder.
- 2 In the **Component Parameters** pane, select the circuit whose position you want to change.
- 3 Click **Up** or **Down** until the circuit is where you want it.



To reverse the positions of Component1 and Network1 in the network shown in the following figure:

- 1** Select Network in the **RF Component List** pane.
- 2** Select Component1 in the **Component Parameters** pane.
- 3** Click **Down** in the **Component Parameters** pane.

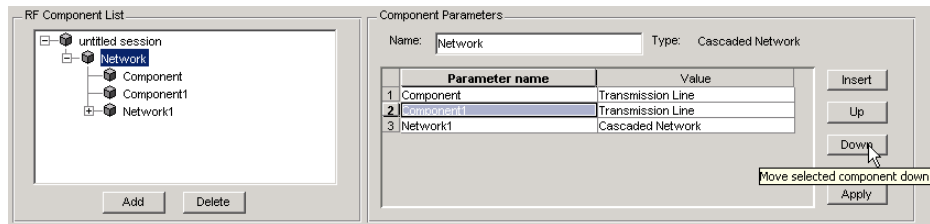

## Import RF Objects into RF Tool

RF Tool lets you import RF objects from your workspace and from files to the top level of your session. You can import the following types of objects:

- Complex component and network objects that you created in your workspace using RF Toolbox objects.
- Components and networks you exported into your workspace from another RF Tool session.

For information on exporting components and networks from an RF Tool session, see “Export RF Objects from RF Tool” on page 5-23.

After you have imported an object, you can change its name and work with it as you would any other component or network.

This section contains the following topics:

- “Import from the Workspace” on page 5-16
- “Import from a File into a Session” on page 5-16
- “Import from a File into a Network” on page 5-18

## Import from the Workspace

To import RF circuit objects from the MATLAB workspace into your RF Tool session:

- 1 Select **Import From Workspace** from the **File** menu. The Import from Workspace dialog box appears. This dialog box lists the handles of all RF circuit (rfckt) objects in the workspace.

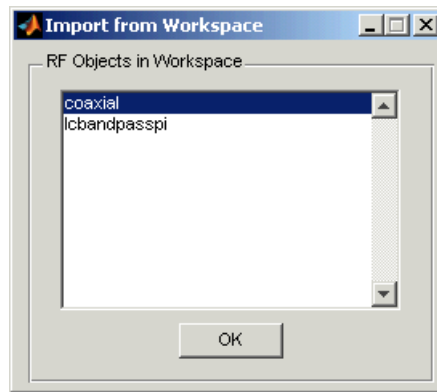

- 2 From the list of RF circuit objects, select the object you want to import, and click **OK**.

The object is added to your session with the same name as the object handle. If there is already a circuit by that name, RF Tool appends a numeral, starting with 1, to the new circuit name.

## Import from a File into a Session

You can import RF components from the following types of files into the top level of your session:

- S2P
- Y2P
- Z2P
- H2P

To import a component from one of these files:

- 1 Select **Import From File** from the **File** menu. A file browser appears.
- 2 Select the file type you want to import.
- 3 Select the name of the file to import from the list of files in the browser.

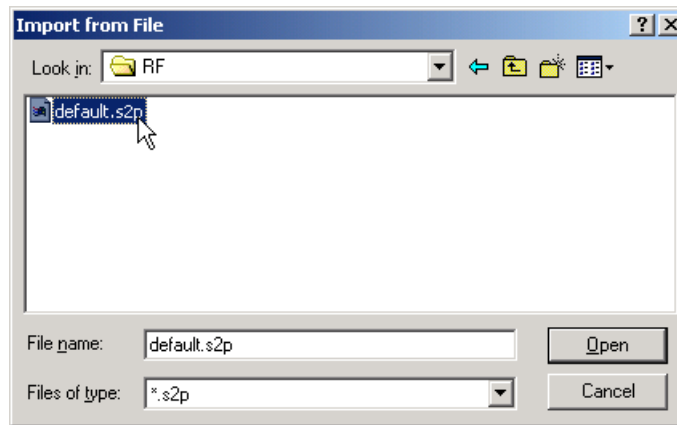

- 4 Click **Open** to add the object to your session as a component.

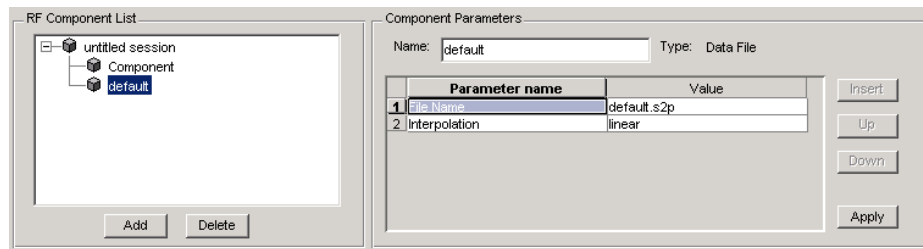

The name of the component is the file name without the extension. If there is already a component by that name, RF Tool appends a numeral, starting with 1, to the new component name. The file name, including the extension, appears as the value of the component's File Name parameter. If the file is not on the MATLAB path, the value of the File Name parameter also contains the file path.

## **Import from a File into a Network**

You can import RF components from the following types of files into a network:

- S2P
- Y2P
- Z2P
- H2P

To import an RF component from a file into a network:

- 1** Insert a Data File component into the network.

For more information on how add a component to a network, see “Populate an RF Network” on page 5-13.

- 2** Specify the name of the file from which to import the component in one of two ways:
  - Select the file name in the file name and type in the Import from File dialog box, and click **Open**.
  - Click **Cancel** to get out of the Import from File dialog box, and enter the file name in the **Value** field across from the **File Name** parameter in the Insert Component or Network dialog box.

“Model an RF Network Using RF Tool” on page 5-31 shows this process.

## Modify Component Data in RF Tool

You can change the values of component parameters that you create and import. The component parameters in RF Tool correspond to the component properties that you specify in the command line.

To modify these values:

- 1** Select the component in the **RF Component List** pane.
- 2** In the **Component Parameters** pane, select the value you want to change, and enter the new value.

Valid values for component parameters are listed on the corresponding RF Toolbox reference page. Use the links in “Available RF Components” on page 5-7 and “Available RF Networks” on page 5-11 to access these pages.

- 3** Click **Apply**.

## Analyze Circuits Using RF Tool

After you add your circuits, you can analyze them with RF Tool:

- 1 Select the component or network you want to analyze in the **RF Component List** pane of RF Tool. For example, select the LC Bandpass Pi component, as shown in the following figure.

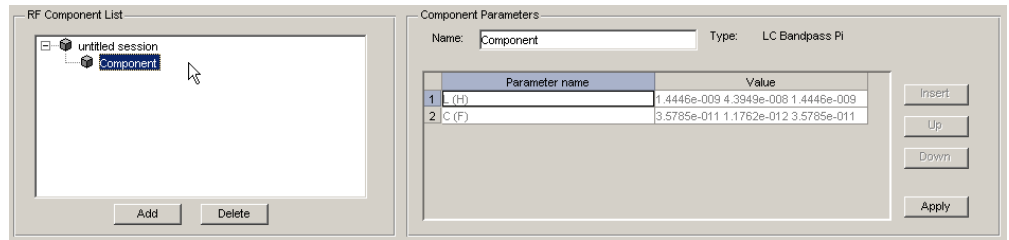

- 2 In the **Analysis** pane:

- Enter [1e8:5e6:2e9], the analysis frequency range and step size in hertz, in the **Frequency** field.

This value specifies an analysis from 0.1 GHz to 2 GHz in 5 MHz steps.

- Enter 50, the reference impedance in ohms, in the **Reference impedance** field.

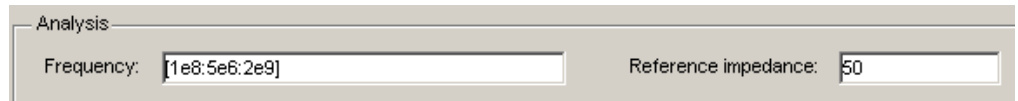



---

**Note** Alternately, you can specify the **Frequency** and **Reference impedance** values as MATLAB workspace variables or as valid MATLAB expressions.

---

### 3 Click Analyze.

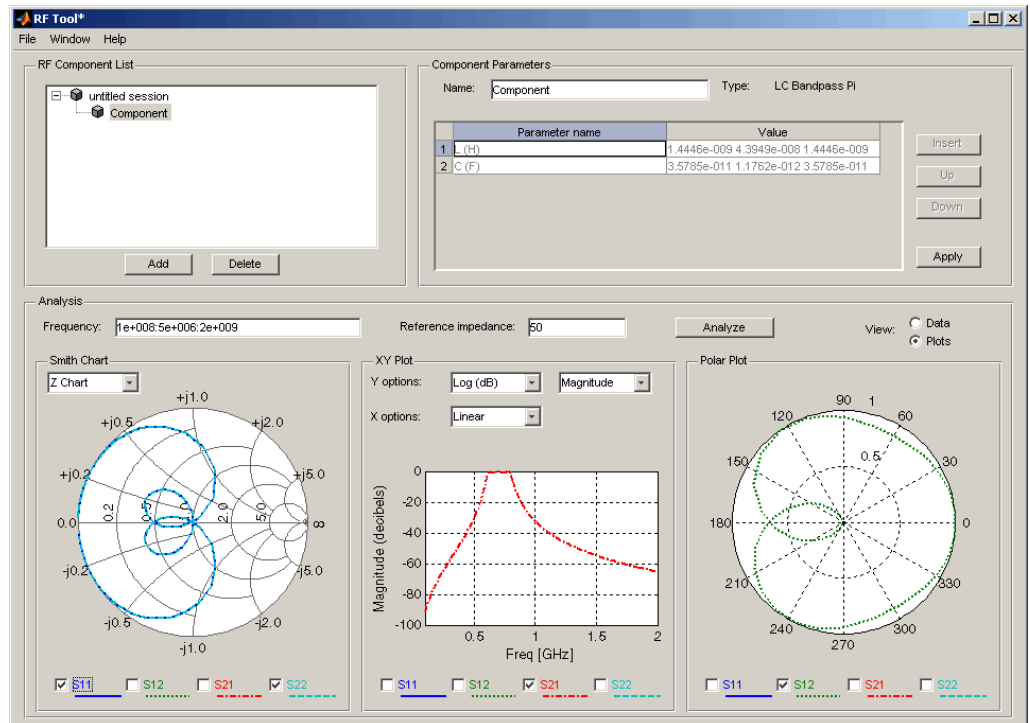
The **Analysis** pane displays a Smith Chart, an XY plot, and a polar plot of the analyzed circuit.



### 4 Select or deselect the S-parameter check boxes at the bottom of each plot to customize the parameters that the plot displays. Use the pull-downs at the top of each plot to customize the plot options.

The plots automatically update as you change the check box and pull-down options on the GUI.

- 5 Click **Data** in the upper-right corner of the **Analysis** pane to view the data in tabular form. The following figure shows the analysis data for the LC Bandpass Pi component at the frequencies and reference impedance shown in step 2.

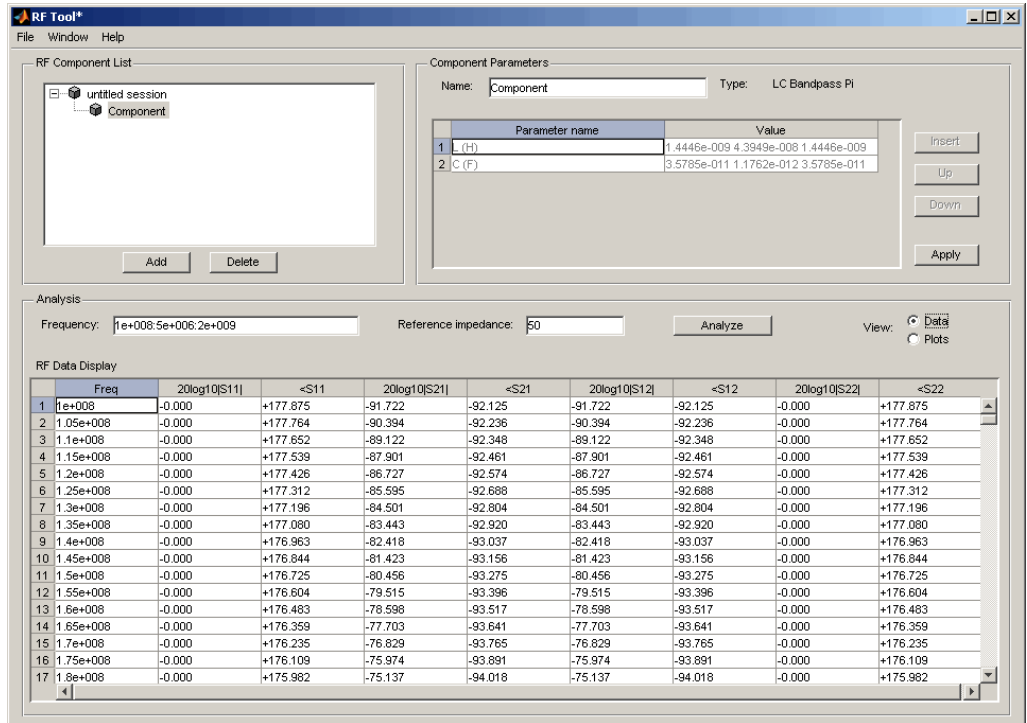

**Note** The magnitude, in decibels, of  $S_{11}$  is listed in the 20log10[S11] column and the phase, in degrees, of  $S_{11}$  is listed in the <S11 column.



## Export RF Objects from RF Tool

In this section...
“Export Components and Networks” on page 5-23
“Export to the Workspace” on page 5-23
“Export to a File” on page 5-25

### Export Components and Networks

You can export RF components and networks that you create and refine in RF Tool to your MATLAB workspace or to files. You export circuits for the following reasons:

- To perform additional analysis using RF Toolbox functions that are not available in RF Tool.
- To incorporate them into larger RF systems.
- To import them into another session.

### Export to the Workspace

RF Tool enables you to export components and networks to the MATLAB workspace. In your workspace, you can use the resulting circuit (`rfckt`) object as you would any other RF circuit object.

To export a component or network to the workspace:

- 1** Select the component or network to export in the **RF Component List** pane of RF Tool.

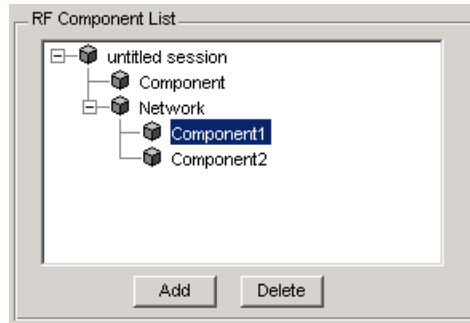

- 2** Select **Export to Workspace** from the **File** menu.
- 3** Enter a name for the exported object's handle in the **Variable name** field and click **OK**. The default name is the name of the component or network prefaced with the string 'rft\_'.

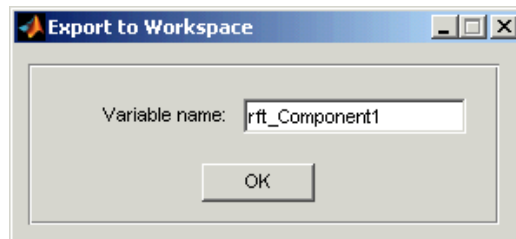

The component or network becomes accessible in the workspace via the specified object handle.

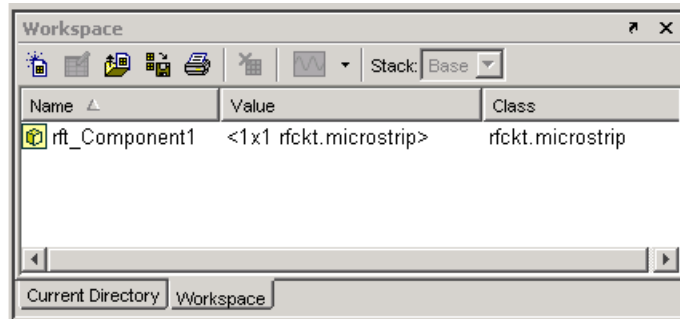

## Export to a File

RF Tool lets you export components and networks to files in S2P format.

---

**Note** You must analyze a component or network in RF Tool before you can export it to a file. See “Analyze Circuits Using RF Tool” on page 5-20 for more information.

---

To export a component or network to a file:

- 1 Select the component or network to export in the **RF Component List** pane of RF Tool.

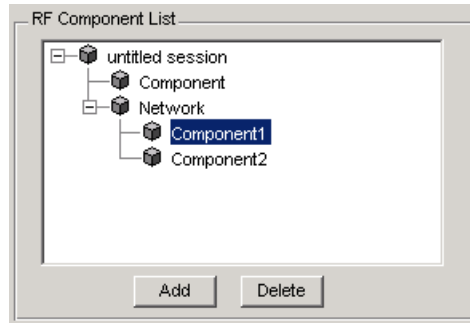

- 2 Select **Export To File** from the **File** menu to open the file browser.

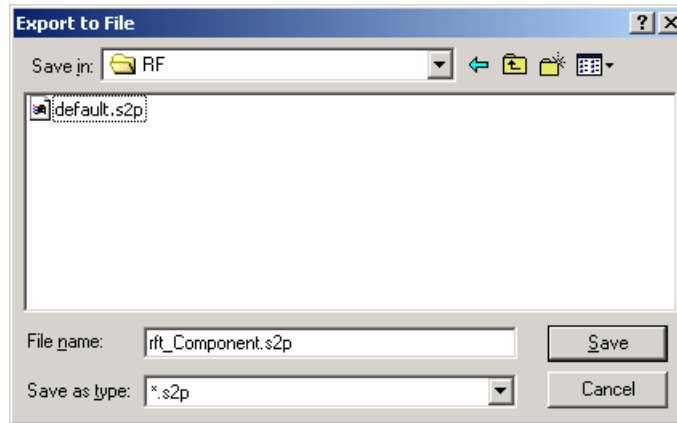

- 3 Browse to the appropriate directory. Enter the name you want to give the file and click **Save**.

The default file name is the current name of the component or network prefaced with the string 'rft\_'. RF Tool also converts any characters that are not alphanumeric to underscores (\_).

## Manage Circuits and Sessions in RF Tool

### In this section...

“Working with Circuits” on page 5-27

“Working with RF Tool Sessions” on page 5-28

### Working with Circuits

In addition to building and specifying circuits, the RF Tool GUI allows you to perform the following tasks:

- “Delete a Circuit” on page 5-27
- “Rename a Circuit” on page 5-28

### Delete a Circuit

To delete a circuit from your session:

- 1 Select the circuit in the **RF Component List** pane.
- 2 Click **Delete**.

**Note** If the circuit you delete is a network, RF Tool deletes the network everything in the network.

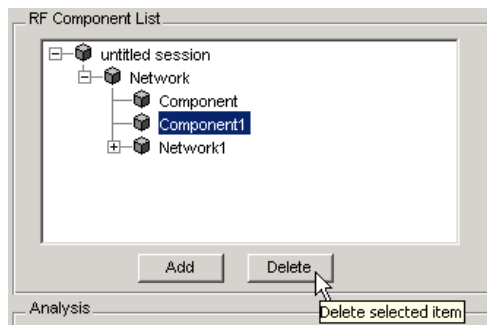

### Rename a Circuit

To rename a component or a network:

- 1 Select the component or network in the **RF Component List** pane.
- 2 Type the new name in the **Name** field of the **Component Parameters** pane.
- 3 Click **Apply**.

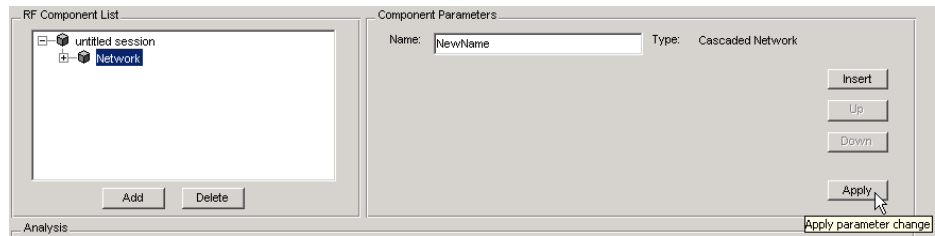

### Working with RF Tool Sessions

The work you do with RF Tool is organized into sessions. Each session is a collection of independent RF circuits, which can be RF components or RF networks.

This section contains the following topics:

- “Name or Rename a Session” on page 5-28
- “Save a Session” on page 5-29
- “Open a Session” on page 5-30
- “Start a New Session” on page 5-30

### Name or Rename a Session

To name or rename an RF Tool session:

- 1 Select the session, or top-level node, in the **RF Component List** pane. (The session is selected by default when you open the RF Tool GUI.)

- 2 Type the desired name in the **Name** field of the **Component Parameters** pane.
- 3 Click **Apply**.

### Save a Session

To save your session, select **Save Session** or **Save Session As** from the **File** menu. The first time you save a session a browser opens, prompting you for a file name.

---

**Note** The default file name is the session name with any characters that are not alphanumeric converted to underscores (\_). The name of the session itself is unchanged.

---

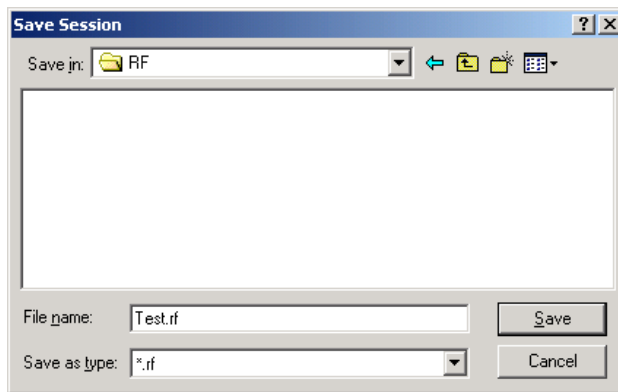

For example, to save your session as **Test.rf** in your current working directory, you would type **Test** in the **File name** field as shown above. RF Tool adds the **.rf** extension automatically to all RF Tool sessions you save.

If the name of your session is **gk's session**, the default file name is **gk\_s\_session.rf**.

## Open a Session

You can load an existing session into RF Tool by selecting **Open Session** from the **File** menu. A browser enables you to select from your previously saved sessions.

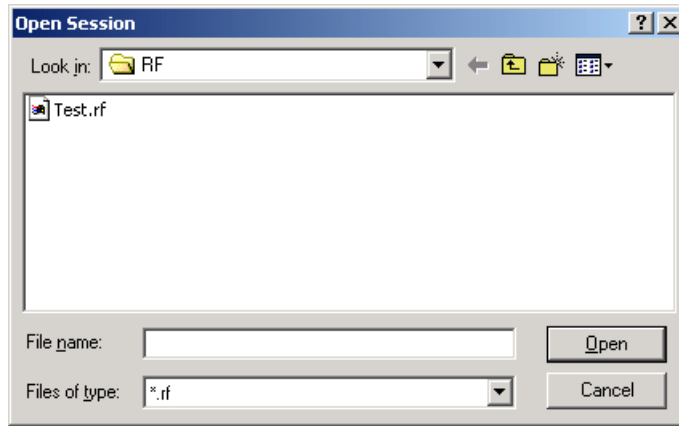

Before opening the requested session, RF Tool prompts you to save your current session.

## Start a New Session

To start a new session, select **New Session** from the **File** menu. A new session opens in RF Tool. All its values are set to their defaults.

Before starting a new session, RF Tool prompts you to save your current session.



## Model an RF Network Using RF Tool

### In this section...

“Overview” on page 5-31

“Start RF Tool” on page 5-31

“Create the Amplifier Network” on page 5-31

“Populate the Amplifier Network” on page 5-34

“Analyze the Amplifier Network” on page 5-38

“Export the Network to the Workspace” on page 5-39

### Overview

In this example, you model the gain and noise figure of a cascaded network and then analyze the network using RF Tool.

The network used in this example consists of an amplifier and two transmission lines. Here, you learn how to create and analyze the network using RF Tool.

### Start RF Tool

Type the following command at the MATLAB prompt to open the RF Tool window:

```
rftool
```

For more information about this GUI, see “RF Tool Window” on page 5-3.

### Create the Amplifier Network

In this part of the example, you create a network to connect the amplifier components in cascade.

**1** In the **RF Component List** pane, click **Add**.

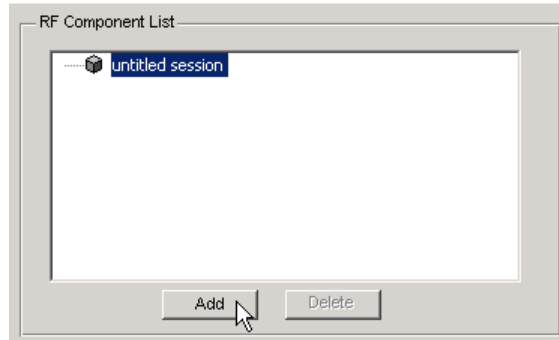

The Create Network or Component dialog box opens.

**2** In the Create Network or Component dialog box:

- Select the **Network** option button.
- In the **Network Name** field, enter Amplifier Network.

This name is used to identify the network in the **RF Component List** pane.

- In the **Network Type** list, select Cascaded Network.

A Cascaded Network means that when you add components to the network, RF Tool connects them in cascade.

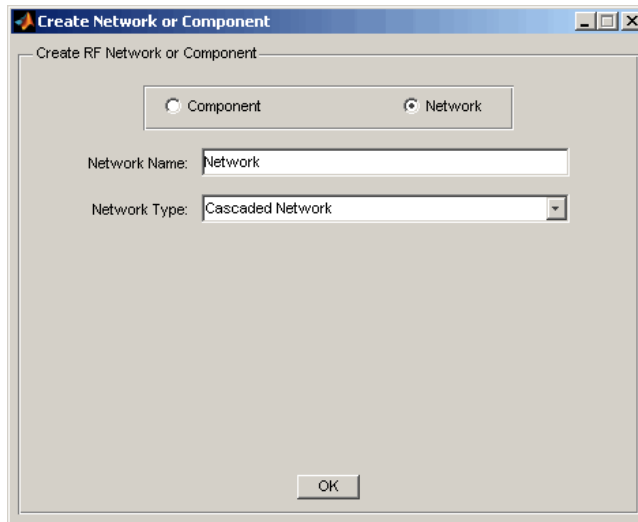

- 3 Click **OK** to add the cascaded network to the session.

The network now appears in the **RF Component List** pane.

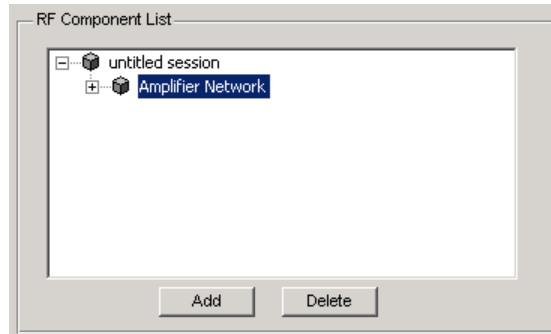

## Populate the Amplifier Network

This part of the example shows how to add the following components to the network:

- “Transmission Line 1” on page 5-34
- “Amplifier” on page 5-35
- “Transmission Line 2” on page 5-37

### Transmission Line 1

- 1 In the **Component Parameters** pane, click **Insert** to open the Insert Component or Network dialog box.

**2** In the Insert Component or Network dialog box:

- Select the **Component** option button.
- In the **Component Name** field, enter Short Transmission Line.  
This name is used to identify the component in the **RF Component List** pane.
- In the **Component Type** pull-down list, select Transmission Line.
- In the **Value** field across from the **Line Length (m)** parameter, enter 0.001.

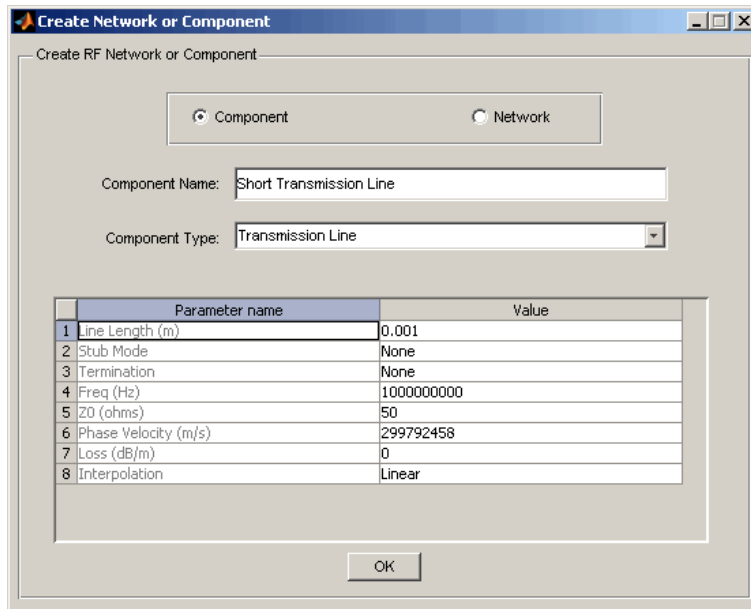

**3** Click **OK** to add the transmission line to the network.

## Amplifier

**1** In the **Component Parameters** pane, click **Insert** to open the Insert Component or Network dialog box.

**2** In the Insert Component or Network dialog box:

- Select the **Component** option button.
- In the **Component Name** field, enter Amplifier.

This name is used to identify the component in the **RF Component List** pane.

- In the **Component Type** list, select Data File.
- In the Import from File dialog box that appears, click **Cancel** . You will specify the name of the file from which to import data in a later step.
- In the **Value** field across from the **Interpolation** parameter, enter cubic.

This value tells RF Tool to use cubic interpolation to determine the behavior of the amplifier at frequency values that are not specified explicitly in the data file.

- In the **Value** field across from the **File Name** parameter, enter default.amp.

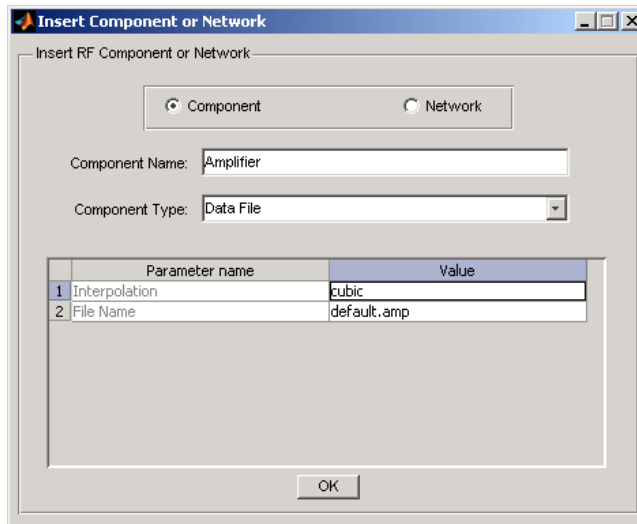

**3** Click **OK** to add the amplifier to the network.

## Transmission Line 2

- 1 In the **Component Parameters** pane, click **Insert** to open the Insert Component or Network dialog box.
- 2 In the Insert Component or Network dialog box, perform the following actions:
  - Select the **Component** option button.
  - In the **Component Name** field, enter Long Transmission Line.  
This name is used to identify the component in the **RF Component List** pane.
  - In the **Component Type** list, select Transmission Line.
  - In the **Value** field across from the **Line Length (m)** parameter, enter 0.025.
  - In the **Value** field across from the **Phase Velocity (m/s)** parameter, enter 2.0e8.

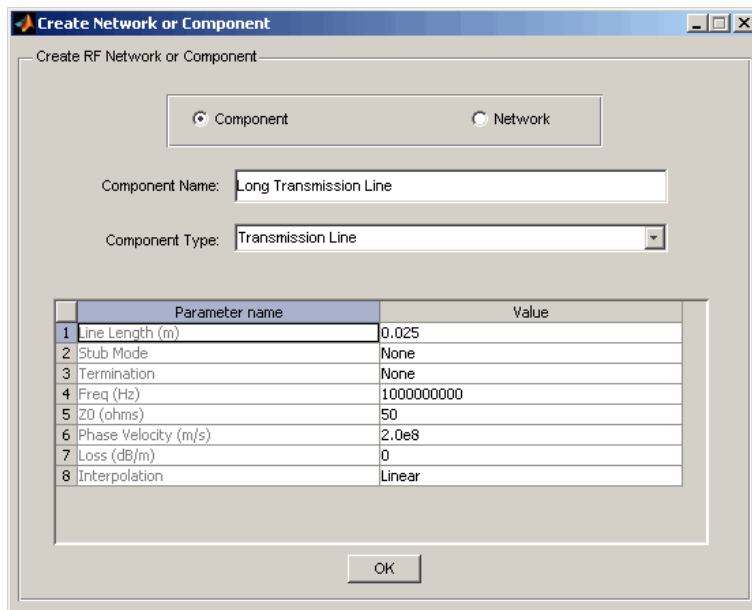

**3** Click **OK** to add the transmission line to the network.

## Analyze the Amplifier Network

In this part of the example, you specify the range of frequencies over which to analyze the amplifier network and then run the analysis.

**1** In the **Analysis** pane, change the **Frequency** entry to [1.0e9:1e7:2.9e9].

This value specifies an analysis from 1 GHz to 2.9 GHz by 10 MHz.

In the **Analysis** pane, click **Analyze** to simulate the network at the specified frequencies.

RF Tool displays a Smith Chart, an XY plot, and a polar plot of the analyzed circuit.

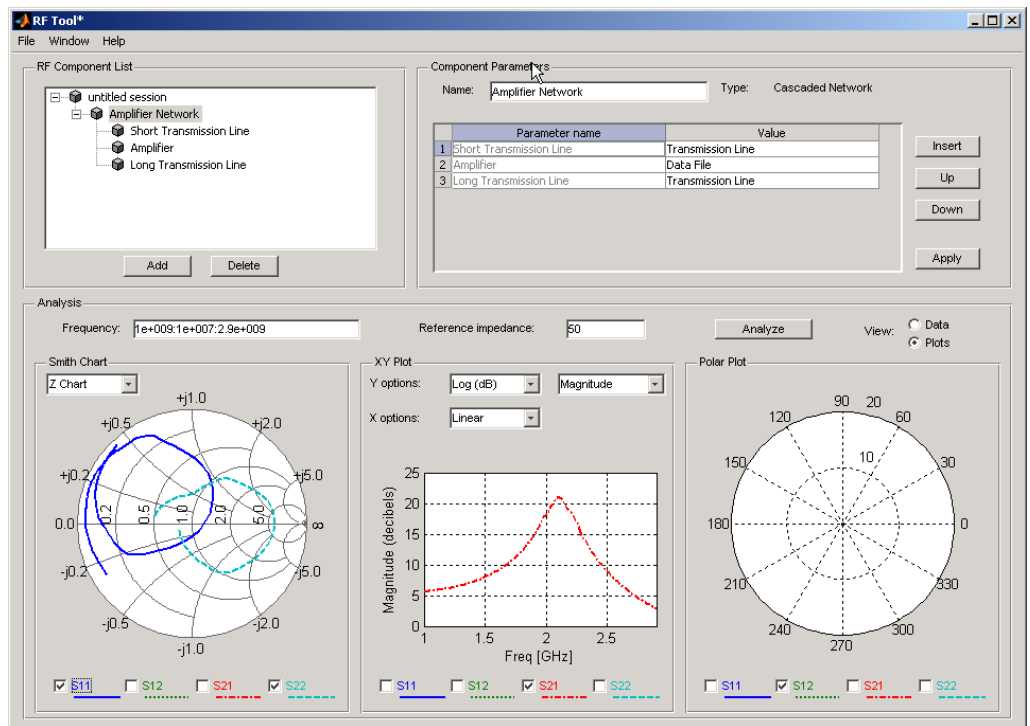



You can modify the plots by

- Selecting and deselecting the S-parameter check boxes at the bottom of each plot to customize the parameters that the plot displays.
- Using the pull-downs at the top of each plot to customize the plot options.

## Export the Network to the Workspace

RF Tool lets you export components and networks to the workspace as circuit objects so you can use the RF Toolbox functions to perform additional analysis. This part of the example shows how to export the amplifier network to the workspace.

- 1 In the RF Tool window, select **File > Export to Workspace**.
- 2 In the **Variable name** field, enter `CascadedCkt`.

This name is the exported object's handle.

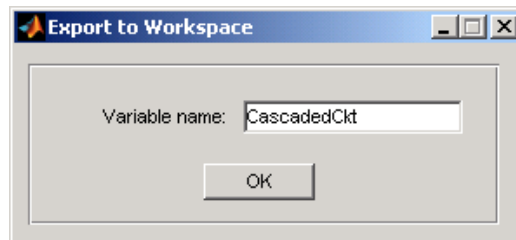

- 3 Click **OK**.

RF Tool exports the amplifier network to an `rfckt.cascade` object, with the specified object handle, in the MATLAB workspace.

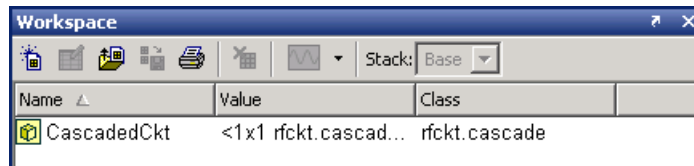



# Object Reference

---

Analysis Objects (p. 6-2)

Analyze RF network properties for RF system design

Circuit Objects (p. 6-3)

Create objects that represent RF components and networks for frequency-domain simulation

Data Objects (p. 6-5)

Create objects that store data

Model Objects (p. 6-6)

Create objects that represent RF components and networks for computing time-domain behavior and exporting models

## **Analysis Objects**

OpenIF

Find open intermediate frequencies (IFs) in multiband transmitter or receiver architecture

## Circuit Objects

Components (p. 6-3)

Represent individual RF components

Networks (p. 6-4)

Represent networks of RF components

### Components

#### Active Components

`rfckt.amplifier`

RF amplifier

`rfckt.mixer`

2-port representation of RF mixer and its local oscillator

#### Ladder Filters

`rfckt.lcbandpasspi`

Bandpass pi filter

`rfckt.lcbandpasstee`

Bandpass tee filter

`rfckt.lcbandstoppi`

Bandstop pi filter

`rfckt.lcbandstoptee`

Bandstop tee filter

`rfckt.lchighpasspi`

Highpass pi filter

`rfckt.lchighpasstee`

Highpass tee filter

`rfckt.lclowpasspi`

Lowpass pi filter

`rfckt.lclowpasstee`

Lowpass tee filter

#### RLC Components

`rfckt.seriesrlc`

Series RLC component

`rfckt.shuntrlc`

Shunt RLC component

## **Transmission Lines**

<code>rfckt.coaxial</code>	Coaxial transmission line
<code>rfckt.cpw</code>	Coplanar waveguide transmission line
<code>rfckt.delay</code>	Delay line
<code>rfckt.microstrip</code>	Microstrip transmission line
<code>rfckt.parallelplate</code>	Parallel-plate transmission line
<code>rfckt.rlcgline</code>	RLCG transmission line
<code>rfckt.twowire</code>	Two-wire transmission line
<code>rfckt.txline</code>	General transmission line

## **Black Box Elements**

<code>rfckt.datafile</code>	Component or network from file data
<code>rfckt.passive</code>	Passive component or network

## **Networks**

<code>rfckt.cascade</code>	Cascaded network
<code>rfckt.hybrid</code>	Hybrid connected network
<code>rfckt.hybridg</code>	Inverse hybrid connected network
<code>rfckt.parallel</code>	Parallel connected network
<code>rfckt.series</code>	Series connected network

## Data Objects

<code>rfdata.data</code>	Store result of circuit object analysis
<code>rfdata.ip3</code>	Store frequency-dependent, third-order intercept points
<code>rfdata.mixerspur</code>	Store data from intermodulation table
<code>rfdata.network</code>	Store frequency-dependent network parameters
<code>rfdata.nf</code>	Store frequency-dependent noise figure data for amplifiers or mixers
<code>rfdata.noise</code>	Store frequency-dependent spot noise data for amplifiers or mixers
<code>rfdata.power</code>	Store output power and phase information for amplifiers or mixers

## **Model Objects**

`rfmodel.rational`

Rational function model



# Objects — Alphabetical List

---

# OpenIF

---

<b>Purpose</b>	Find open intermediate frequencies (IFs) in multiband transmitter or receiver architecture
<b>Description</b>	Use the <code>OpenIF</code> class to analyze the spurs and spur-free zones in a multiband transmitter or receiver. This information helps you determine intermediate frequencies (IFs) that do not produce interference in operating bands.
<b>Construction</b>	<p><code>hif = OpenIF</code> creates an intermediate-frequency (IF) planning object with properties set to their default values.</p> <p><code>hif = OpenIF(Name,Value)</code> creates an intermediate-frequency (IF) planning object with properties with additional options specified by one or more <code>Name,Value</code> pair arguments.</p> <p><code>hif = OpenIF(bandwidth)</code> creates an intermediate-frequency (IF) planning object with a specified IF bandwidth.</p> <p><code>hif = OpenIF(bandwidth,Name,Value)</code> creates an IF-planning object with a specified IF bandwidth and additional options specified by one or more <code>Name,Value</code> pair arguments.</p>
<b>Input Arguments</b>	<p><b>bandwidth</b></p> <p>Specify the bandwidth of the IF signal. The bandwidth is a real positive scalar. The value you provide sets the <code>IFBW</code> property of your object. You can also set this property using an optional name-value pair argument.</p>
<b>Name-Value Pair Arguments</b>	<p>Specify optional comma-separated pairs of <code>Name,Value</code> arguments, where <code>Name</code> is the argument name and <code>Value</code> is the corresponding value. <code>Name</code> must appear inside single quotes ( ' '). You can specify several name and value pair arguments in any order as <code>Name1,Value1,...,NameN,ValueN</code>.</p> <p><b>IFLocation - IF location</b></p> <p>'MixerInput'   'MixerOutput' (default)</p>

Specify an up-conversion or down-conversion setup during object construction. The value you provide sets the `IFLocation` property of your object.

### IFBW - IF bandwidth

nonnegative number

Specify the IF bandwidth during object construction. The value you provide sets the `IFBW` property of your object. You can also set this property using the optional `bandwidth` input argument.

### SpurFloor - Spur floor

nonnegative number

Specify the spur floor during object construction. The value you provide sets the `SpurFloor` property of your object.

## Properties

### IFLocation

Specify an up-conversion or down-conversion setup.

- Setting `IFLocation` to 'MixerInput' specifies an up-converting (transmitting) configuration, where one IF is mixed up to multiple RFs. The following figure shows this convention.

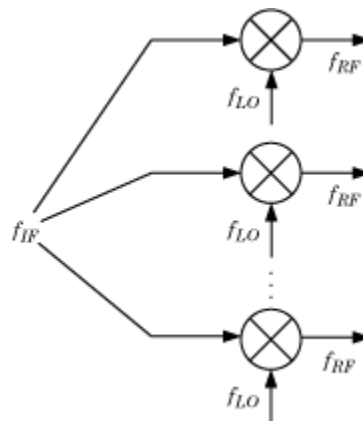

- Setting `IFLocation` to `'MixerOutput'` specifies a down-converting (receiving) configuration, where multiple RFs are mixed down to one IF. The following figure shows this convention.

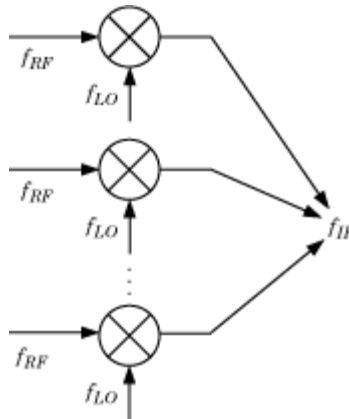

The setting of `IFLocation` determines the available values for the injection argument of the `addMixer` method.

**Default:** `'MixerOutput'`

## **IFBW**

Bandwidth of the IF signal in Hz. When you construct the object, the `bandwidth` argument specifies the value of this property.

## **Mixers**

Vector of objects that holds mixer information. When you add mixers using the `addMixer` method, you also add an `OpenIFMixer` object to the `Mixers` vector of your original `OpenIF` object.

The following table lists the properties of each `OpenIFMixer` object.

Property	Description
IMT	Intermodulation table of the mixer.
RFCF	RF center frequency, in Hz.
RFBW	RF bandwidth, in Hz.
MixingType	Mixing (injection) type.
SpurVector	Vector of spur information.

The IMT, RFCF, RFBW, and MixingType properties are required inputs to the addMixer method.

### NumMixers

Number of mixers. When you use the addMixer method, the number of mixers increases by one. The likelihood of finding an open IF decreases as you add mixers.

### SpurFloor

Maximum difference in magnitude between a signal at 0 dBc and an intermodulation product that the OpenIF object considers a spur. The default value of this parameter is 99, corresponding to a spur floor of -99 dBc.

## Methods

addMixer	Add mixer to multiband transmitter or receiver for IF planning analysis
getSpurData	Find spurs in multiband transmitter or receiver frequency space
getSpurFreeZoneData	Find spur-free zones in multiband transmitter or receiver frequency space

report	Summarize mixer configurations and spur-free-zone information for a multiband transmitter or receiver
show	Produce a spur graph for a multiband transmitter or receiver

## Copy Semantics

Handle. To learn how handle classes affect copy operations, see Copying Objects in the MATLAB Programming Fundamentals documentation.

## Examples

### Spur-free zones of a multiband receiver

Set up an OpenIF object as a multiband receiver, add three mixers to it, and obtain information about its spur-free zones.

Define an OpenIF object. The first input is the bandwidth of the IF signal (50 MHz). The 'IFLocation', 'MixerOutput' name-value pair specifies a downconverting configuration.

```
hif = OpenIF(50e6, 'IFLocation', 'MixerOutput');
```

Define the first mixer with an intermodulation table and add it to the OpenIF object. Mixer 1 has an LO at 2.4 GHz, has a bandwidth of 100 MHz, and uses low-side injection.

```
IMT1 = [99 00 21 17 26; ...  
        11 00 29 29 63; ...  
        60 48 70 65 41; ...  
        90 89 74 68 87; ...  
        99 99 95 99 99];  
addMixer(hif, IMT1, 2.4e9, 100e6, 'low');
```

Mixer 2 has an LO at 3.7 GHz, has a bandwidth of 150 MHz, and uses low-side injection.

```
IMT2 = [99 00 09 12 15; ...  
        20 00 26 31 48; ...
```

```

        55 70 51 70 53; ...
        85 90 60 70 94; ...
        96 95 94 93 92];
addMixer(hif,IMT2,3.7e9,150e6,'low');

```

Mixer 3 has an LO at 5 GHz, has a bandwidth of 200 MHz, and uses low-side injection.

```

IMT3 = [99 00 15 23 36; ...
        10 00 34 27 59; ...
        67 61 56 59 68; ...
        97 82 81 60 77; ...
        99 99 99 99 96];
addMixer(hif,IMT3,5e9,200e6,'low');

```

The multiband receiver is fully defined and ready for spur-free-zone analysis. Use the `report` method to analyze and display spur and spur-free zone information at the command line. The method also returns information about the mixers in the receiver.

```
hif.report
```

```

Intermediate Frequency (IF) Planner
IF Location: MixerOutput

-- MIXER 1 --
RF Center Frequency: 2.4 GHz
RF Bandwidth: 100 MHz
IF Bandwidth: 50 MHz
MixerType: low
Intermodulation Table:

```

	99	0	21	17	26
	11	0	29	29	63
	60	48	70	65	41
	90	89	74	68	87
	99	99	95	99	99

```
-- MIXER 2 --  
RF Center Frequency: 3.7 GHz  
RF Bandwidth: 150 MHz  
IF Bandwidth: 50 MHz  
MixerType: low  
Intermodulation Table:  99  0  9  12  15  
                        20  0  26  31  48  
                        55  70  51  70  53  
                        85  90  60  70  94  
                        96  95  94  93  92
```

```
-- MIXER 3 --  
RF Center Frequency: 5 GHz  
RF Bandwidth: 200 MHz  
IF Bandwidth: 50 MHz  
MixerType: low  
Intermodulation Table:  99  0  15  23  36  
                        10  0  34  27  59  
                        67  61  56  59  68  
                        97  82  81  60  77  
                        99  99  99  99  96
```

```
Spur-Free Zones:  
350.00 - 430.00 MHz  
530.00 - 556.25 MHz  
643.75 - 655.00 MHz  
1.38 - 1.41 GHz  
2.10 - 2.17 GHz  
2.28 - 2.29 GHz
```

Use the `show` method to analyze the receiver and produce an interactive spur graph. Generating a spur graph is a convenient way to summarize the results of the analysis graphically.

```
figure;  
hif.show
```



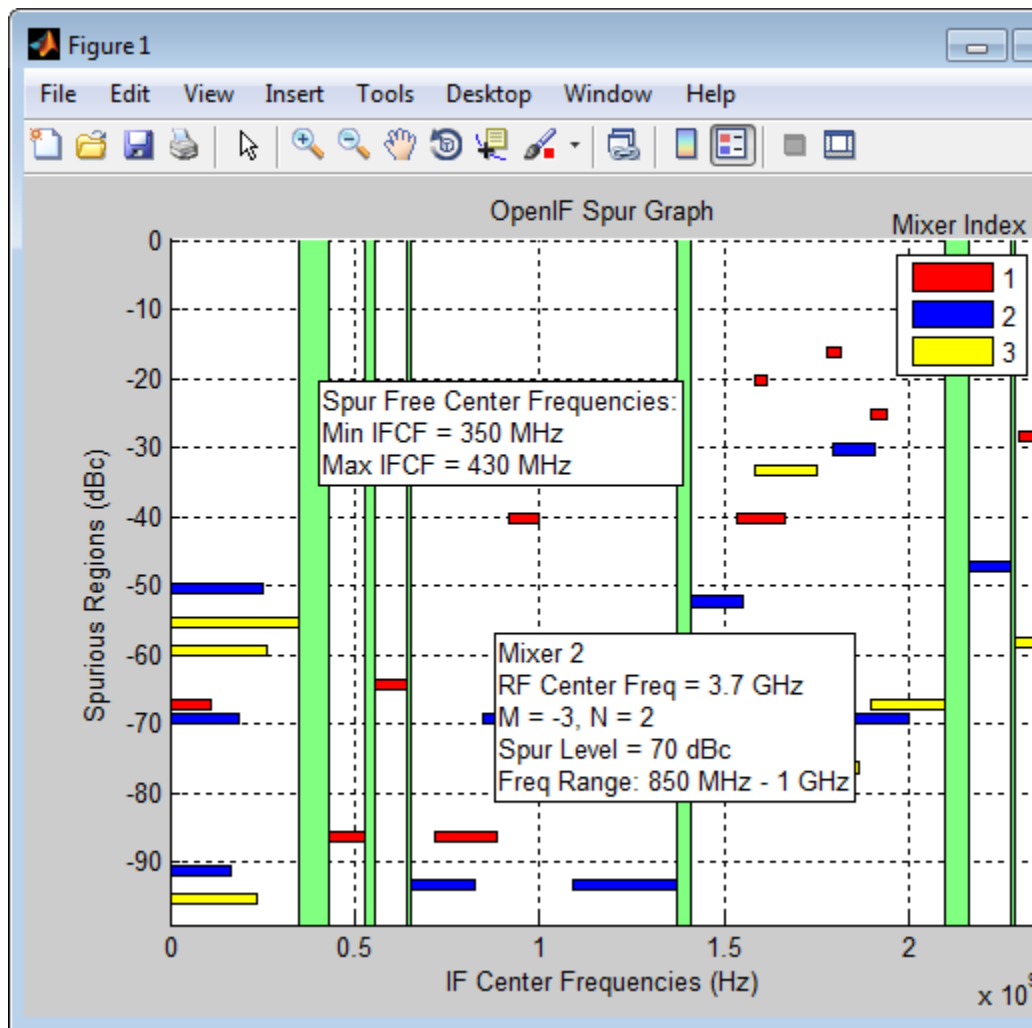

## References

Faria, Daniel, Lawrence Dunleavy, and Terje Svensen. "The Use of Intermodulation Tables for Mixer Simulations." *Microwave Journal*. Vol. 45, No. 4, December 2002, p. 60.

# rfckt.amplifier

---

**Purpose** RF amplifier

**Syntax**  
`h = rfckt.amplifier`  
`h = rfckt.amplifier('Property1',value1,'Property2',value2, ...)`

**Description** Use the `amplifier` class to represent RF amplifiers that are characterized by network parameters, noise data, and nonlinearity data.

`h = rfckt.amplifier` returns an amplifier circuit object whose properties all have their default values.

`h = rfckt.amplifier('Property1',value1,'Property2',value2,...)` returns a circuit object, `h`, based on the specified properties. Properties that you do not specify retain their default values.

Use the `read` method to read the amplifier data from a data file in one of the following formats:

- Touchstone
- Agilent P2D
- Agilent S2D
- AMP

See Appendix A, “AMP File Format” for information about the `.amp` format.

<b>Properties</b>	AnalyzedResult	Computed S-parameters, noise figure, OIP3, and group delay values
	IntpType	Interpolation method
	Name	Object name
	NetworkData	Network parameter information

NoiseData	Noise information
NonlinearData	Nonlinearity information
nPort	Number of ports

## Methods

analyze	Analyze circuit object in frequency domain
analyze	Analyze circuit object in frequency domain
calculate	Calculate specified parameters for circuit object
calculate	Calculate specified parameters for circuit object
circle	Draw circles on Smith chart
circle	Draw circles on Smith chart
extract	Extract array of network parameters from data object
extract	Extract array of network parameters from data object
getop	Display operating conditions
getop	Display operating conditions
listformat	List valid formats for specified circuit object parameter
listformat	List valid formats for specified circuit object parameter
listparam	List valid parameters for specified circuit object
listparam	List valid parameters for specified circuit object

loglog	Plot specified circuit object parameters using log-log scale
loglog	Plot specified circuit object parameters using log-log scale
plot	Plot specified circuit object parameters on X-Y plane
plot	Plot specified circuit object parameters on X-Y plane
plotyy	Plot specified object parameters with <i>y</i> -axes on both left and right sides
plotyy	Plot specified object parameters with <i>y</i> -axes on both left and right sides
polar	Plot specified circuit object parameters on polar coordinates
polar	Plot specified circuit object parameters on polar coordinates
read	Read RF data from file to new or existing circuit or data object
read	Read RF data from file to new or existing circuit or data object
restore	Restore data to original frequencies
restore	Restore data to original frequencies
semilogx	Plot specified circuit object parameters using log scale for <i>x</i> -axis

semilogx	Plot specified circuit object parameters using log scale for <i>x</i> -axis
semilogy	Plot specified circuit object parameters using log scale for <i>x</i> -axis
semilogy	Plot specified circuit object parameters using log scale for <i>x</i> -axis
smith	Plot specified circuit object parameters on Smith chart
smith	Plot specified circuit object parameters on Smith chart
write	Write RF data from circuit or data object to file
write	Write RF data from circuit or data object to file

## Examples

```
amp = rfckt.amplifier('IntpType','cubic')
```

```
amp =
```

```

Name: 'Amplifier'
nPort: 2
AnalyzedResult: [1x1 rfdata.data]
IntpType: 'Cubic'
NetworkData: [1x1 rfdata.network]
NoiseData: [1x1 rfdata.noise]
NonlinearData: [1x1 rfdata.power]
```

## References

EIA/IBIS Open Forum, *Touchstone File Format Specification*, Rev. 1.1, 2002  
([http://www.vhdl.org/pub/ibis/connector/touchstone\\_spec11.pdf](http://www.vhdl.org/pub/ibis/connector/touchstone_spec11.pdf)).

# rfckt.amplifier

---

## **See Also**

`rfckt.datafile` | `rfckt.mixer` | `rfckt.passive` | `rfdata.data`  
| `rfdata.ip3` | `rfdata.network` | `rfdata.nf` | `rfdata.noise` |  
`rfdata.power`

## Purpose

Cascaded network

## Syntax

```
h = rfckt.cascade
h = rfckt.cascade('Property1',value1,'Property2',value2,...)
```

## Description

Use the `cascade` class to represent cascaded networks of RF objects that are characterized by the components that make up the network. The following figure shows the configuration of a pair of cascaded networks.

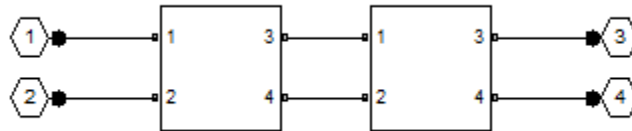

`h = rfckt.cascade` returns a cascaded network object whose properties all have their default values.

`h =`

`rfckt.cascade('Property1',value1,'Property2',value2,...)` returns a cascaded network object, `h`, based on the specified properties. Properties you do not specify retain their default values.

## Properties

AnalyzedResult	Computed S-parameters, noise figure, OIP3, and group delay values
Ckts	Circuit objects in network
Name	Object name
nPort	Number of ports

## Methods

analyze	Analyze circuit object in frequency domain
analyze	Analyze circuit object in frequency domain
calculate	Calculate specified parameters for circuit object
calculate	Calculate specified parameters for circuit object
circle	Draw circles on Smith chart
circle	Draw circles on Smith chart
listformat	List valid formats for specified circuit object parameter
listformat	List valid formats for specified circuit object parameter
listparam	List valid parameters for specified circuit object
listparam	List valid parameters for specified circuit object
loglog	Plot specified circuit object parameters using log-log scale
loglog	Plot specified circuit object parameters using log-log scale
plot	Plot specified circuit object parameters on X-Y plane
plot	Plot specified circuit object parameters on X-Y plane
plotyy	Plot specified object parameters with y-axes on both left and right sides



plotyy	Plot specified object parameters with <i>y</i> -axes on both left and right sides
polar	Plot specified circuit object parameters on polar coordinates
polar	Plot specified circuit object parameters on polar coordinates
semilogx	Plot specified circuit object parameters using log scale for <i>x</i> -axis
semilogx	Plot specified circuit object parameters using log scale for <i>x</i> -axis
semilogy	Plot specified circuit object parameters using log scale for <i>x</i> -axis
semilogy	Plot specified circuit object parameters using log scale for <i>x</i> -axis
smith	Plot specified circuit object parameters on Smith chart
smith	Plot specified circuit object parameters on Smith chart
write	Write RF data from circuit or data object to file
write	Write RF data from circuit or data object to file

## Examples

```
amp = rfckt.amplifier('IntpType','cubic');
tx1 = rfckt.txline;
tx2 = rfckt.txline;
casc = rfckt.cascade('Ckts',{tx1,amp,tx2})
```

cas =

```
Name: 'Cascaded Network'  
nPort: 2  
AnalyzedResult: []  
Ckts: {1x3 cell}
```

## References

Ludwig, R. and P. Bretchko, *RF Circuit Design: Theory and Applications*, Prentice Hall, 2000.

## See Also

[rfckt.hybrid](#) | [rfckt.hybridg](#) | [rfckt.parallel](#) | [rfckt.series](#)

**Purpose** Coaxial transmission line

**Syntax**  
`h = rfckt.coaxial`  
`h = rfckt.coaxial('Property1',value1,'Property2',value2,...)`

**Description** Use the coaxial class to represent coaxial transmission lines that are characterized by line dimensions, stub type, and termination.

A coaxial transmission line is shown in cross-section in the following figure. Its physical characteristics include the radius of the inner conductor of the coaxial transmission line  $a$ , and the radius of the outer conductor  $b$ .

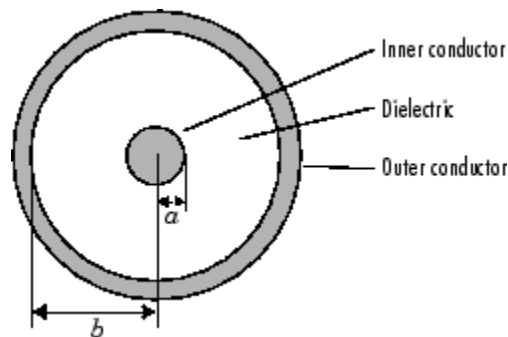

`h = rfckt.coaxial` returns a coaxial transmission line object whose properties are set to their default values.

`h = rfckt.coaxial('Property1',value1,'Property2',value2,...)` returns a coaxial transmission line object, `h`, with the specified properties. Properties that you do not specify retain their default values.

**Properties**

AnalyzedResult	Computed S-parameters, noise figure, OIP3, and group delay values
EpsilonR	Relative permittivity of dielectric

InnerRadius	Inner conductor radius
LineLength	Transmission line length
LossTangent	Tangent of loss angle
MuR	Relative permeability of dielectric
Name	Object name
nPort	Number of ports
OuterRadius	Outer conductor radius
SigmaCond	Conductor conductivity
StubMode	Type of stub
Termination	Stub transmission line termination

## Methods

analyze	Analyze circuit object in frequency domain
analyze	Analyze circuit object in frequency domain
calculate	Calculate specified parameters for circuit object
calculate	Calculate specified parameters for circuit object
circle	Draw circles on Smith chart
circle	Draw circles on Smith chart
getz0	Characteristic impedance of transmission line object
getz0	Characteristic impedance of transmission line object

---

listformat	List valid formats for specified circuit object parameter
listformat	List valid formats for specified circuit object parameter
listparam	List valid parameters for specified circuit object
listparam	List valid parameters for specified circuit object
loglog	Plot specified circuit object parameters using log-log scale
loglog	Plot specified circuit object parameters using log-log scale
plot	Plot specified circuit object parameters on X-Y plane
plot	Plot specified circuit object parameters on X-Y plane
plotyy	Plot specified object parameters with <i>y</i> -axes on both left and right sides
plotyy	Plot specified object parameters with <i>y</i> -axes on both left and right sides
polar	Plot specified circuit object parameters on polar coordinates
polar	Plot specified circuit object parameters on polar coordinates
semilogx	Plot specified circuit object parameters using log scale for <i>x</i> -axis

semilogx	Plot specified circuit object parameters using log scale for <i>x</i> -axis
semilogy	Plot specified circuit object parameters using log scale for <i>x</i> -axis
semilogy	Plot specified circuit object parameters using log scale for <i>x</i> -axis
smith	Plot specified circuit object parameters on Smith chart
smith	Plot specified circuit object parameters on Smith chart
write	Write RF data from circuit or data object to file
write	Write RF data from circuit or data object to file

## Examples

```
tx1=rfckt.coaxial('OuterRadius',0.0045)
```

```
tx1 =
```

```
Name: 'Coaxial Transmission Line'  
nPort: 2  
AnalyzedResult: []  
LineLength: 0.0100  
StubMode: 'NotAStub'  
Termination: 'NotApplicable'  
OuterRadius: 0.0045  
InnerRadius: 7.2500e-004  
MuR: 1  
EpsilonR: 2.3000  
LossTangent: 0
```

SigmaCond: Inf

**References**

Pozar, David M. *Microwave Engineering*, John Wiley & Sons, Inc., 2005.

**See Also**

rfckt.cpw | rfckt.microstrip | rfckt.parallelplate |  
rfckt.rlcgline | rfckt.twowire | rfckt.txline

**Purpose** Coplanar waveguide transmission line

**Syntax**  
`h = rfckt.cpw`  
`h = rfckt.cpw('Property1',value1,'Property2',value2,...)`

**Description** Use the cpw class to represent coplanar waveguide transmission lines that are characterized by line dimensions, stub type, and termination.

A coplanar waveguide transmission line is shown in cross-section in the following figure. Its physical characteristics include the conductor width ( $w$ ), the conductor thickness ( $t$ ), the slot width ( $s$ ), the substrate height ( $d$ ), and the permittivity constant ( $\epsilon$ ).

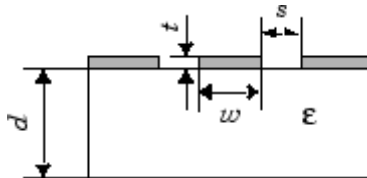

`h = rfckt.cpw` returns a coplanar waveguide transmission line object whose properties are set to their default values.

`h = rfckt.cpw('Property1',value1,'Property2',value2,...)` returns a coplanar waveguide transmission line object, `h`, with the specified properties. Properties that you do not specify retain their default values.

<b>Properties</b>	AnalyzedResult	Computed S-parameters, noise figure, OIP3, and group delay values
	ConductorWidth	Conductor width
	EpsilonR	Relative permittivity of dielectric
	Height	Dielectric thickness
	LineLength	Transmission line length



LossTangent	Tangent of loss angle
Name	Object name
nPort	Number of ports
SigmaCond	Conductor conductivity
SlotWidth	Width of slot
StubMode	Type of stub
Termination	Stub transmission line termination
Thickness	Conductor thickness

## Methods

analyze	Analyze circuit object in frequency domain
analyze	Analyze circuit object in frequency domain
calculate	Calculate specified parameters for circuit object
calculate	Calculate specified parameters for circuit object
circle	Draw circles on Smith chart
circle	Draw circles on Smith chart
getz0	Characteristic impedance of transmission line object
getz0	Characteristic impedance of transmission line object
listformat	List valid formats for specified circuit object parameter

listformat	List valid formats for specified circuit object parameter
listparam	List valid parameters for specified circuit object
listparam	List valid parameters for specified circuit object
loglog	Plot specified circuit object parameters using log-log scale
loglog	Plot specified circuit object parameters using log-log scale
plot	Plot specified circuit object parameters on X-Y plane
plot	Plot specified circuit object parameters on X-Y plane
plotyy	Plot specified object parameters with <i>y</i> -axes on both left and right sides
plotyy	Plot specified object parameters with <i>y</i> -axes on both left and right sides
polar	Plot specified circuit object parameters on polar coordinates
polar	Plot specified circuit object parameters on polar coordinates
semilogx	Plot specified circuit object parameters using log scale for <i>x</i> -axis
semilogx	Plot specified circuit object parameters using log scale for <i>x</i> -axis

semilogy	Plot specified circuit object parameters using log scale for <i>x</i> -axis
semilogy	Plot specified circuit object parameters using log scale for <i>x</i> -axis
smith	Plot specified circuit object parameters on Smith chart
smith	Plot specified circuit object parameters on Smith chart
write	Write RF data from circuit or data object to file
write	Write RF data from circuit or data object to file

## Examples

```
tx1=rfckt.cpw('Thickness',0.0075e-6)
```

```
tx1 =
```

```
Name: 'Coplanar Waveguide Transmission Line'
nPort: 2
AnalyzedResult: []
LineLength: 0.0100
StubMode: 'NotAStub'
Termination: 'NotApplicable'
ConductorWidth: 6.0000e-004
SlotWidth: 2.0000e-004
Height: 6.3500e-004
Thickness: 7.5000e-009
EpsilonR: 9.8000
SigmaCond: Inf
LossTangent: 0
```

## References

[1] Gupta, K. C., R. Garg, I. Bahl, and P. Bhartia, *Microstrip Lines and Slotlines*, 2nd Edition, Artech House, Inc., Norwood, MA, 1996.

## See Also

rfckt.coaxial | rfckt.microstrip | rfckt.parallelplate |  
rfckt.rlcgline | rfckt.twowire | rfckt.txline

## Purpose

Component or network from file data

## Syntax

```
h = rfckt.datafile
h = rfckt.datafile('Property1',value1,'Property2',value2,...)
```

## Description

Use the `datafile` class to represent RF components and networks that are characterized by measured or simulated data in a file.

`h = rfckt.datafile` returns a circuit object whose properties all have their default values.

```
h =
rfckt.datafile('Property1',value1,'Property2',value2,...)
returns a circuit object, h, based on the specified properties. Properties
that you do not specify retain their default values.
```

Use the `read` method to read the data from a file in one of the following formats:

- Touchstone
- Agilent P2D
- Agilent S2D
- AMP

See Appendix A, “AMP File Format” for information about the `.amp` format.

## Properties

AnalyzedResult	Computed S-parameters, noise figure, OIP3, and group delay values
File	File containing circuit data
IntpType	Interpolation method

Name	Object name
nPort	Number of ports

## Methods

analyze	Analyze circuit object in frequency domain
analyze	Analyze circuit object in frequency domain
calculate	Calculate specified parameters for circuit object
calculate	Calculate specified parameters for circuit object
circle	Draw circles on Smith chart
circle	Draw circles on Smith chart
extract	Extract array of network parameters from data object
extract	Extract array of network parameters from data object
listformat	List valid formats for specified circuit object parameter
listformat	List valid formats for specified circuit object parameter
listparam	List valid parameters for specified circuit object
listparam	List valid parameters for specified circuit object
loglog	Plot specified circuit object parameters using log-log scale

loglog	Plot specified circuit object parameters using log-log scale
plot	Plot specified circuit object parameters on X-Y plane
plot	Plot specified circuit object parameters on X-Y plane
plotyy	Plot specified object parameters with $y$ -axes on both left and right sides
plotyy	Plot specified object parameters with $y$ -axes on both left and right sides
polar	Plot specified circuit object parameters on polar coordinates
polar	Plot specified circuit object parameters on polar coordinates
read	Read RF data from file to new or existing circuit or data object
read	Read RF data from file to new or existing circuit or data object
restore	Restore data to original frequencies
restore	Restore data to original frequencies
semilogx	Plot specified circuit object parameters using log scale for $x$ -axis
semilogx	Plot specified circuit object parameters using log scale for $x$ -axis

semilogy	Plot specified circuit object parameters using log scale for <i>x</i> -axis
semilogy	Plot specified circuit object parameters using log scale for <i>x</i> -axis
smith	Plot specified circuit object parameters on Smith chart
smith	Plot specified circuit object parameters on Smith chart
write	Write RF data from circuit or data object to file
write	Write RF data from circuit or data object to file

## Examples

```
data=rfckt.datafile('File','default.s2p')
```

```
data =
```

```
      Name: 'Data File'  
      nPort: 2  
      AnalyzedResult: [1x1 rfddata.data]  
      IntpType: 'Linear'  
      File: 'default.s2p'
```

## References

EIA/IBIS Open Forum, *Touchstone File Format Specification*, Rev. 1.1, 2002  
([http://www.vhdl.org/pub/ibis/connector/touchstone\\_spec11.pdf](http://www.vhdl.org/pub/ibis/connector/touchstone_spec11.pdf)).

## See Also

rfckt.amplifier | rfckt.mixer | rfckt.passive |  
[http://www.vhdl.org/pub/ibis/connector/touchstone\\_spec11.pdf](http://www.vhdl.org/pub/ibis/connector/touchstone_spec11.pdf)



<b>Purpose</b>	Delay line	
<b>Syntax</b>	<pre>h = rfckt.delay h = rfckt.delay('Property1',value1,'Property2',value2,...)</pre>	
<b>Description</b>	<p>Use the <code>delay</code> class to represent delay lines that are characterized by line loss and time delay.</p> <p><code>h = rfckt.delay</code> returns a delay line object whose properties are set to their default values.</p> <p><code>h = rfckt.delay('Property1',value1,'Property2',value2,...)</code> returns a delay line object, <code>h</code>, with the specified properties. Properties that you do not specify retain their default values.</p>	
<b>Properties</b>	<p>AnalyzedResult</p> <p>Loss</p> <p>Name</p> <p>nPort</p> <p>TimeDelay</p> <p>Z0</p>	<p>Computed S-parameters, noise figure, OIP3, and group delay values</p> <p>Delay line loss</p> <p>Object name</p> <p>Number of ports</p> <p>Delay introduced by line</p> <p>Characteristic impedance</p>
<b>Methods</b>	<p>analyze</p> <p>analyze</p> <p>calculate</p>	<p>Analyze circuit object in frequency domain</p> <p>Analyze circuit object in frequency domain</p> <p>Calculate specified parameters for circuit object</p>

calculate	Calculate specified parameters for circuit object
circle	Draw circles on Smith chart
circle	Draw circles on Smith chart
getz0	Characteristic impedance of transmission line object
getz0	Characteristic impedance of transmission line object
listformat	List valid formats for specified circuit object parameter
listformat	List valid formats for specified circuit object parameter
listparam	List valid parameters for specified circuit object
listparam	List valid parameters for specified circuit object
loglog	Plot specified circuit object parameters using log-log scale
loglog	Plot specified circuit object parameters using log-log scale
plot	Plot specified circuit object parameters on X-Y plane
plot	Plot specified circuit object parameters on X-Y plane
ploty	Plot specified object parameters with <i>y</i> -axes on both left and right sides
ploty	Plot specified object parameters with <i>y</i> -axes on both left and right sides

polar	Plot specified circuit object parameters on polar coordinates
polar	Plot specified circuit object parameters on polar coordinates
semilogx	Plot specified circuit object parameters using log scale for <i>x</i> -axis
semilogx	Plot specified circuit object parameters using log scale for <i>x</i> -axis
semilogy	Plot specified circuit object parameters using log scale for <i>x</i> -axis
semilogy	Plot specified circuit object parameters using log scale for <i>x</i> -axis
smith	Plot specified circuit object parameters on Smith chart
smith	Plot specified circuit object parameters on Smith chart
write	Write RF data from circuit or data object to file
write	Write RF data from circuit or data object to file

**Examples**

```
del=rfckt.delay('TimeDelay',1e-11)
```

```
del =
```

```
    Name: 'Delay Line'  
    nPort: 2  
    AnalyzedResult: []
```

# rfckt.delay

---

Z0: 50  
Loss: 0  
TimeDelay: 1.0000e-011

## References

Ludwig, R. and P. Bretchko, *RF Circuit Design: Theory and Applications*, Prentice-Hall, 2000.

## See Also

rfckt.rlcgline | rfckt.txline

**Purpose** Hybrid connected network

**Syntax**  
`h = rfckt.hybrid`  
`h = rfckt.hybrid('Property1',value1,'Property2',value2,...)`

**Description** Use the hybrid class to represent hybrid connected networks of linear RF objects that are characterized by the components that make up the network.

`h = rfckt.hybrid` returns a hybrid connected network object whose properties all have their default values.

`h = rfckt.hybrid('Property1',value1,'Property2',value2,...)` returns a hybrid connected network object, `h`, based on the specified properties. Properties that you do not specify retain their default values.

**Properties**

AnalyzedResult	Computed S-parameters, noise figure, OIP3, and group delay values
Ckts	Circuit objects in network
Name	Object name
nPort	Number of ports

**Methods**

<code>analyze</code>	Analyze circuit object in frequency domain
<code>analyze</code>	Analyze circuit object in frequency domain
<code>calculate</code>	Calculate specified parameters for circuit object
<code>calculate</code>	Calculate specified parameters for circuit object

circle	Draw circles on Smith chart
circle	Draw circles on Smith chart
listformat	List valid formats for specified circuit object parameter
listformat	List valid formats for specified circuit object parameter
listparam	List valid parameters for specified circuit object
listparam	List valid parameters for specified circuit object
loglog	Plot specified circuit object parameters using log-log scale
loglog	Plot specified circuit object parameters using log-log scale
plot	Plot specified circuit object parameters on X-Y plane
plot	Plot specified circuit object parameters on X-Y plane
plotyy	Plot specified object parameters with y-axes on both left and right sides
plotyy	Plot specified object parameters with y-axes on both left and right sides
polar	Plot specified circuit object parameters on polar coordinates
polar	Plot specified circuit object parameters on polar coordinates

semilogx	Plot specified circuit object parameters using log scale for <i>x</i> -axis
semilogx	Plot specified circuit object parameters using log scale for <i>x</i> -axis
semilogy	Plot specified circuit object parameters using log scale for <i>x</i> -axis
semilogy	Plot specified circuit object parameters using log scale for <i>x</i> -axis
smith	Plot specified circuit object parameters on Smith chart
smith	Plot specified circuit object parameters on Smith chart
write	Write RF data from circuit or data object to file
write	Write RF data from circuit or data object to file

## Examples

```
tx1 = rfckt.txline;
tx2 = rfckt.txline;
hyb = rfckt.hybrid('Ckts',{tx1,tx2})
```

```
hyb =
```

```
Name: 'Hybrid Connected Network'
nPort: 2
AnalyzedResult: []
Ckts: {1x2 cell}
```

**References**

Ludwig, R. and P. Bretchko, *RF Circuit Design: Theory and Applications*, Prentice-Hall, 2000.

**See Also**

`rfckt.cascade` | `rfckt.hybridg` | `rfckt.parallel` | `rfckt.series`



<b>Purpose</b>	Inverse hybrid connected network	
<b>Syntax</b>	<pre>h = rfckt.hybridg h = rfckt.hybridg('Property1',value1,'Property2',value2,...)</pre>	
<b>Description</b>	<p>Use the <code>hybridg</code> class to represent inverse hybrid connected networks of linear RF objects that are characterized by the components that make up the network.</p> <p><code>h = rfckt.hybridg</code> returns an inverse hybrid connected network object whose properties all have their default values.</p> <p><code>h = rfckt.hybridg('Property1',value1,'Property2',value2,...)</code> returns an inverse hybrid connected network object, <code>h</code>, based on the specified properties. Properties that you do not specify retain their default values.</p>	
<b>Properties</b>	<p>AnalyzedResult</p> <p>Ckts</p> <p>Name</p> <p>nPort</p>	<p>Computed S-parameters, noise figure, OIP3, and group delay values</p> <p>Circuit objects in network</p> <p>Object name</p> <p>Number of ports</p>
<b>Methods</b>	<p>analyze</p> <p>analyze</p> <p>calculate</p>	<p>Analyze circuit object in frequency domain</p> <p>Analyze circuit object in frequency domain</p> <p>Calculate specified parameters for circuit object</p>

calculate	Calculate specified parameters for circuit object
circle	Draw circles on Smith chart
circle	Draw circles on Smith chart
listformat	List valid formats for specified circuit object parameter
listformat	List valid formats for specified circuit object parameter
listparam	List valid parameters for specified circuit object
listparam	List valid parameters for specified circuit object
loglog	Plot specified circuit object parameters using log-log scale
loglog	Plot specified circuit object parameters using log-log scale
plot	Plot specified circuit object parameters on X-Y plane
plot	Plot specified circuit object parameters on X-Y plane
plotyy	Plot specified object parameters with y-axes on both left and right sides
plotyy	Plot specified object parameters with y-axes on both left and right sides
polar	Plot specified circuit object parameters on polar coordinates
polar	Plot specified circuit object parameters on polar coordinates

semilogx	Plot specified circuit object parameters using log scale for <i>x</i> -axis
semilogx	Plot specified circuit object parameters using log scale for <i>x</i> -axis
semilogy	Plot specified circuit object parameters using log scale for <i>x</i> -axis
semilogy	Plot specified circuit object parameters using log scale for <i>x</i> -axis
smith	Plot specified circuit object parameters on Smith chart
smith	Plot specified circuit object parameters on Smith chart
write	Write RF data from circuit or data object to file
write	Write RF data from circuit or data object to file

## Examples

```
tx1 = rfckt.txline;
tx2 = rfckt.txline;
invhyb = rfckt.hybridg('Ckts',{tx1,tx2})
```

```
invhyb =
```

```
Name: 'Hybrid G Connected Network'
nPort: 2
AnalyzedResult: []
Ckts: {1x2 cell}
```

## References

Davis, A.M., *Linear Circuit Analysis*, PWS Publishing Company, 1998.

# rfckt.hybridg

---

## **See Also**

`rfckt.cascade` | `rfckt.hybrid` | `rfckt.parallel` | `rfckt.series`

## Purpose

Bandpass pi filter

## Syntax

```
h = rfckt.lcbandpasspi
h = rfckt.lcbandpasspi('Property1',value1,'Property2',value2,
    ...)
```

## Description

Use the `lcbandpasspi` class to represent a bandpass pi filter as a network of inductors and capacitors.

The LC bandpass pi network object is a 2-port network as shown in the following circuit diagram.

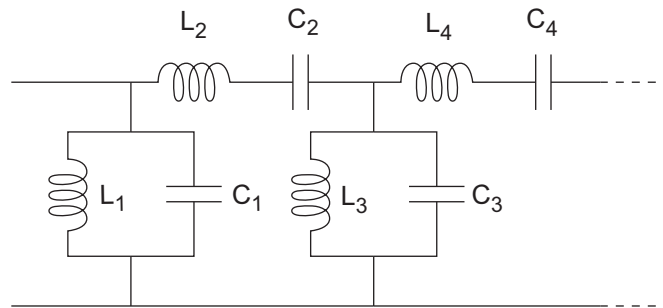

In the diagram,  $[L_1, L_2, L_3, L_4, \dots]$  is the value of the 'L' object property, and  $[C_1, C_2, C_3, C_4, \dots]$  is the value of the 'C' object property.

`h = rfckt.lcbandpasspi` returns an LC bandpass pi network object whose properties all have their default values.

`h = rfckt.lcbandpasspi('Property1',value1,'Property2',value2,...)` returns an LC bandpass pi network object, `h`, based on the specified properties. Properties that you do not specify retain their default values.

## Properties

AnalyzedResult	Computed S-parameters, noise figure, OIP3, and group delay values
C	Capacitance data
L	Inductance data
Name	Object name
nPort	Number of ports

## Methods

analyze	Analyze circuit object in frequency domain
analyze	Analyze circuit object in frequency domain
calculate	Calculate specified parameters for circuit object
calculate	Calculate specified parameters for circuit object
circle	Draw circles on Smith chart
circle	Draw circles on Smith chart
extract	Extract array of network parameters from data object
extract	Extract array of network parameters from data object
listformat	List valid formats for specified circuit object parameter
listformat	List valid formats for specified circuit object parameter
listparam	List valid parameters for specified circuit object

listparam	List valid parameters for specified circuit object
loglog	Plot specified circuit object parameters using log-log scale
loglog	Plot specified circuit object parameters using log-log scale
plot	Plot specified circuit object parameters on X-Y plane
plot	Plot specified circuit object parameters on X-Y plane
plotyy	Plot specified object parameters with <i>y</i> -axes on both left and right sides
plotyy	Plot specified object parameters with <i>y</i> -axes on both left and right sides
polar	Plot specified circuit object parameters on polar coordinates
polar	Plot specified circuit object parameters on polar coordinates
semilogx	Plot specified circuit object parameters using log scale for <i>x</i> -axis
semilogx	Plot specified circuit object parameters using log scale for <i>x</i> -axis
semilogy	Plot specified circuit object parameters using log scale for <i>x</i> -axis

# rfckt.lcbandpasspi

---

semilogy	Plot specified circuit object parameters using log scale for $x$ -axis
smith	Plot specified circuit object parameters on Smith chart
smith	Plot specified circuit object parameters on Smith chart
write	Write RF data from circuit or data object to file
write	Write RF data from circuit or data object to file

## Examples

```
filter = rfckt.lcbandpasspi...  
        ('C',[1e-12 4e-12], 'L',[2e-9 2.5e-9])
```

```
filter =
```

```
      Name: 'LC Bandpass Pi'  
      nPort: 2  
      AnalyzedResult: []  
      L: [2x1 double]  
      C: [2x1 double]
```

## References

Ludwig, R. and P. Bretchko, *RF Circuit Design: Theory and Applications*, Prentice-Hall, 2000.

Zverev, A.I., *Handbook of Filter Synthesis*, John Wiley & Sons, 1967.

## See Also

```
rfckt.lcbandpasstee | rfckt.lcbandstoppi | rfckt.lcbandstoptee  
| rfckt.lchighpasspi | rfckt.lchighpasstee | rfckt.lclowpasspi  
| rfckt.lclowpasstee
```



**Purpose** Bandpass tee filter

**Syntax**

```
h = rfckt.lcbandpasstee
h = rfckt.lcbandpasstee('Property1',value1,'Property2',value2,
    ...)
```

**Description** Use the `lcbandpasstee` class to represent a bandpass tee filter as a network of inductors and capacitors.

The LC bandpass tee network object is a 2-port network as shown in the following circuit diagram.

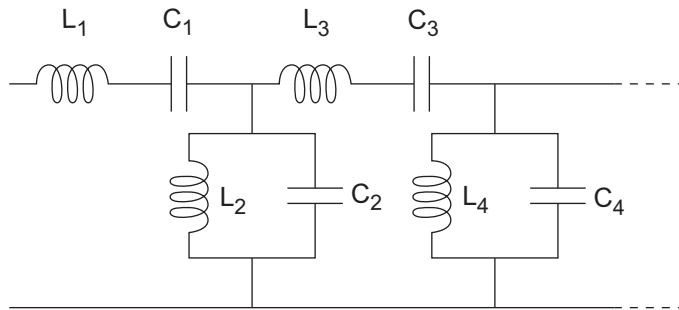

In the diagram,  $[L_1, L_2, L_3, L_4, \dots]$  is the value of the 'L' object property, and  $[C_1, C_2, C_3, C_4, \dots]$  is the value of the 'C' object property.

`h = rfckt.lcbandpasstee` returns an LC bandpass tee network object whose properties all have their default values.

`h = rfckt.lcbandpasstee('Property1',value1,'Property2',value2, ...)` returns an LC bandpass tee network object, `h`, based on the specified properties. Properties that you do not specify retain their default values.

## Properties

AnalyzedResult	Computed S-parameters, noise figure, OIP3, and group delay values
C	Capacitance data
L	Inductance data
Name	Object name
nPort	Number of ports

## Methods

analyze	Analyze circuit object in frequency domain
analyze	Analyze circuit object in frequency domain
calculate	Calculate specified parameters for circuit object
calculate	Calculate specified parameters for circuit object
circle	Draw circles on Smith chart
circle	Draw circles on Smith chart
extract	Extract array of network parameters from data object
extract	Extract array of network parameters from data object
listformat	List valid formats for specified circuit object parameter
listformat	List valid formats for specified circuit object parameter
listparam	List valid parameters for specified circuit object

listparam	List valid parameters for specified circuit object
loglog	Plot specified circuit object parameters using log-log scale
loglog	Plot specified circuit object parameters using log-log scale
plot	Plot specified circuit object parameters on X-Y plane
plot	Plot specified circuit object parameters on X-Y plane
plotyy	Plot specified object parameters with <i>y</i> -axes on both left and right sides
plotyy	Plot specified object parameters with <i>y</i> -axes on both left and right sides
polar	Plot specified circuit object parameters on polar coordinates
polar	Plot specified circuit object parameters on polar coordinates
semilogx	Plot specified circuit object parameters using log scale for <i>x</i> -axis
semilogx	Plot specified circuit object parameters using log scale for <i>x</i> -axis
semilogy	Plot specified circuit object parameters using log scale for <i>x</i> -axis

# rfckt.lcbandpasstee

---

semilogy	Plot specified circuit object parameters using log scale for $x$ -axis
smith	Plot specified circuit object parameters on Smith chart
smith	Plot specified circuit object parameters on Smith chart
write	Write RF data from circuit or data object to file
write	Write RF data from circuit or data object to file

## Examples

```
filter = rfckt.lcbandpasstee...  
        ('C',[1e-12 4e-12], 'L',[2e-9 2.5e-9])
```

```
filter =
```

```
Name: 'LC Bandpass Tee'  
nPort: 2  
AnalyzedResult: []  
L: [2x1 double]  
C: [2x1 double]
```

## References

Ludwig, R. and P. Bretchko, *RF Circuit Design: Theory and Applications*, Prentice-Hall, 2000.

Zverev, A.I., *Handbook of Filter Synthesis*, John Wiley & Sons, 1967.

## See Also

```
rfckt.lcbandpasspi | rfckt.lcbandstoppi | rfckt.lcbandstoptee  
| rfckt.lchighpasspi | rfckt.lchighpasstee | rfckt.lclowpasspi  
| rfckt.lclowpasstee
```

**Purpose** Bandstop pi filter

**Syntax**  
`h = rfckt.lcbandstoppi`  
`h = rfckt.lcbandstoppi('Property1',value1,'Property2',value2, ...)`

**Description** Use the `lcbandstoppi` class to represent a bandstop pi filter as a network of inductors and capacitors. The LC bandstop pi network object is a 2-port network as shown in the following circuit diagram.

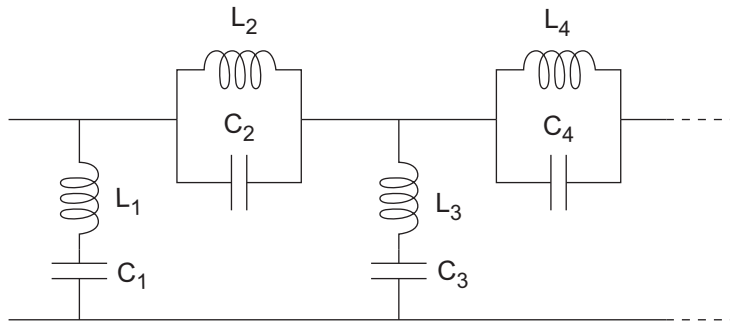

In the diagram,  $[L_1, L_2, L_3, L_4, \dots]$  is the value of the 'L' object property, and  $[C_1, C_2, C_3, C_4, \dots]$  is the value of the 'C' object property.

`h = rfckt.lcbandstoppi` returns an LC bandstop pi network object whose properties all have their default values.

`h = rfckt.lcbandstoppi('Property1',value1,'Property2',value2,...)` returns an LC bandstop pi network object, `h`, based on the specified properties. Properties that you do not specify retain their default values.

## Properties

AnalyzedResult	Computed S-parameters, noise figure, OIP3, and group delay values
C	Capacitance data
L	Inductance data
Name	Object name
nPort	Number of ports

## Methods

analyze	Analyze circuit object in frequency domain
analyze	Analyze circuit object in frequency domain
calculate	Calculate specified parameters for circuit object
calculate	Calculate specified parameters for circuit object
circle	Draw circles on Smith chart
circle	Draw circles on Smith chart
extract	Extract array of network parameters from data object
extract	Extract array of network parameters from data object
listformat	List valid formats for specified circuit object parameter
listformat	List valid formats for specified circuit object parameter
listparam	List valid parameters for specified circuit object

listparam	List valid parameters for specified circuit object
loglog	Plot specified circuit object parameters using log-log scale
loglog	Plot specified circuit object parameters using log-log scale
plot	Plot specified circuit object parameters on X-Y plane
plot	Plot specified circuit object parameters on X-Y plane
plotyy	Plot specified object parameters with <i>y</i> -axes on both left and right sides
plotyy	Plot specified object parameters with <i>y</i> -axes on both left and right sides
polar	Plot specified circuit object parameters on polar coordinates
polar	Plot specified circuit object parameters on polar coordinates
semilogx	Plot specified circuit object parameters using log scale for <i>x</i> -axis
semilogx	Plot specified circuit object parameters using log scale for <i>x</i> -axis
semilogy	Plot specified circuit object parameters using log scale for <i>x</i> -axis

# rfckt.lcbandstoppi

---

semilogy	Plot specified circuit object parameters using log scale for $x$ -axis
smith	Plot specified circuit object parameters on Smith chart
smith	Plot specified circuit object parameters on Smith chart
write	Write RF data from circuit or data object to file
write	Write RF data from circuit or data object to file

## Examples

```
filter = rfckt.lcbandstoppi...  
        ('C',[1e-12 4e-12], 'L',[2e-9 2.5e-9])
```

```
filter =
```

```
      Name: 'LC Bandstop Pi'  
      nPort: 2  
      AnalyzedResult: []  
      L: [2x1 double]  
      C: [2x1 double]
```

## References

Ludwig, R. and P. Bretchko, *RF Circuit Design: Theory and Applications*, Prentice-Hall, 2000.

Zverev, A.I., *Handbook of Filter Synthesis*, John Wiley & Sons, 1967.

## See Also

```
rfckt.lcbandpasspi | rfckt.lcbandpasstee | rfckt.lcbandstoptee  
| rfckt.lchighpasspi | rfckt.lchighpasstee | rfckt.lclowpasspi  
| rfckt.lclowpasstee
```



## Purpose

Bandstop tee filter

## Syntax

```
h = rfckt.lcbandstoptee
h = rfckt.lcbandstoptee('Property1',value1,'Property2',value2,
    ...)
```

## Description

Use the `lcbandstoptee` class to represent a bandstop tee filter as a network of inductors and capacitor. The LC bandstop tee network object is a 2-port network as shown in the following circuit diagram.

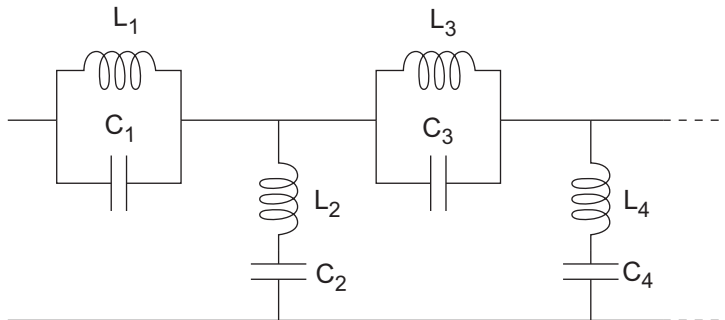

In the diagram,  $[L_1, L_2, L_3, L_4, \dots]$  is the value of the 'L' object property, and  $[C_1, C_2, C_3, C_4, \dots]$  is the value of the 'C' object property.

`h = rfckt.lcbandstoptee` returns an LC bandstop tee network object whose properties all have their default values.

`h =`

`rfckt.lcbandstoptee('Property1',value1,'Property2',value2, ...)` returns an LC bandstop tee network object, `h`, based on the specified properties. Properties that you do not specify retain their default values.

## Properties

AnalyzedResult	Computed S-parameters, noise figure, OIP3, and group delay values
C	Capacitance data
L	Inductance data
Name	Object name
nPort	Number of ports

## Methods

analyze	Analyze circuit object in frequency domain
analyze	Analyze circuit object in frequency domain
calculate	Calculate specified parameters for circuit object
calculate	Calculate specified parameters for circuit object
circle	Draw circles on Smith chart
circle	Draw circles on Smith chart
extract	Extract array of network parameters from data object
extract	Extract array of network parameters from data object
listformat	List valid formats for specified circuit object parameter
listformat	List valid formats for specified circuit object parameter
listparam	List valid parameters for specified circuit object

listparam	List valid parameters for specified circuit object
loglog	Plot specified circuit object parameters using log-log scale
loglog	Plot specified circuit object parameters using log-log scale
plot	Plot specified circuit object parameters on X-Y plane
plot	Plot specified circuit object parameters on X-Y plane
plotyy	Plot specified object parameters with <i>y</i> -axes on both left and right sides
plotyy	Plot specified object parameters with <i>y</i> -axes on both left and right sides
polar	Plot specified circuit object parameters on polar coordinates
polar	Plot specified circuit object parameters on polar coordinates
semilogx	Plot specified circuit object parameters using log scale for <i>x</i> -axis
semilogx	Plot specified circuit object parameters using log scale for <i>x</i> -axis
semilogy	Plot specified circuit object parameters using log scale for <i>x</i> -axis

# rfckt.lcbandstoptee

---

semilogy	Plot specified circuit object parameters using log scale for $x$ -axis
smith	Plot specified circuit object parameters on Smith chart
smith	Plot specified circuit object parameters on Smith chart
write	Write RF data from circuit or data object to file
write	Write RF data from circuit or data object to file

## Examples

```
filter = rfckt.lcbandstoptee...  
        ('C',[1e-12 4e-12], 'L',[2e-9 2.5e-9])
```

```
filter =
```

```
      Name: 'LC Bandstop Tee'  
      nPort: 2  
      AnalyzedResult: []  
      L: [2x1 double]  
      C: [2x1 double]
```

## References

Ludwig, R. and P. Bretchko, *RF Circuit Design: Theory and Applications*, Prentice-Hall, 2000.

Zverev, A.I., *Handbook of Filter Synthesis*, John Wiley & Sons, 1967.

## See Also

```
rfckt.lcbandpasspi | rfckt.lcbandpasstee | rfckt.lcbandstoppi  
| rfckt.lchighpasspi | rfckt.lchighpasstee | rfckt.lclowpasspi  
| rfckt.lclowpasstee
```

**Purpose** Highpass pi filter

**Syntax**  
`h = rfckt.lchighpasspi`  
`h = rfckt.lchighpasspi('Property1',value1,'Property2',value2, ...)`

**Description** Use the `lchighpasspi` class to represent a highpass pi filter as a network of inductors and capacitors.

The LC highpass pi network object is a 2-port network as shown in the following circuit diagram.

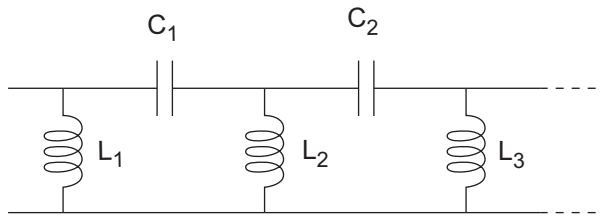

In the diagram,  $[L_1, L_2, L_3, \dots]$  is the value of the 'L' object property, and  $[C_1, C_2, C_3, \dots]$  is the value of the 'C' object property.

`h = rfckt.lchighpasspi` returns an LC highpass pi network object whose properties all have their default values.

`h = rfckt.lchighpasspi('Property1',value1,'Property2',value2, ...)` returns an LC highpass pi network object, `h`, based on the specified properties. Properties that you do not specify retain their default values.

<b>Properties</b>	AnalyzedResult	Computed S-parameters, noise figure, OIP3, and group delay values
	C	Capacitance data
	L	Inductance data

Name	Object name
nPort	Number of ports

## Methods

analyze	Analyze circuit object in frequency domain
analyze	Analyze circuit object in frequency domain
calculate	Calculate specified parameters for circuit object
calculate	Calculate specified parameters for circuit object
circle	Draw circles on Smith chart
circle	Draw circles on Smith chart
extract	Extract array of network parameters from data object
extract	Extract array of network parameters from data object
listformat	List valid formats for specified circuit object parameter
listformat	List valid formats for specified circuit object parameter
listparam	List valid parameters for specified circuit object
listparam	List valid parameters for specified circuit object
loglog	Plot specified circuit object parameters using log-log scale

loglog	Plot specified circuit object parameters using log-log scale
plot	Plot specified circuit object parameters on X-Y plane
plot	Plot specified circuit object parameters on X-Y plane
plotyy	Plot specified object parameters with $y$ -axes on both left and right sides
plotyy	Plot specified object parameters with $y$ -axes on both left and right sides
polar	Plot specified circuit object parameters on polar coordinates
polar	Plot specified circuit object parameters on polar coordinates
semilogx	Plot specified circuit object parameters using log scale for $x$ -axis
semilogx	Plot specified circuit object parameters using log scale for $x$ -axis
semilogy	Plot specified circuit object parameters using log scale for $x$ -axis
semilogy	Plot specified circuit object parameters using log scale for $x$ -axis
smith	Plot specified circuit object parameters on Smith chart

# rfckt.lchighpasspi

---

smith	Plot specified circuit object parameters on Smith chart
write	Write RF data from circuit or data object to file
write	Write RF data from circuit or data object to file

## Examples

```
filter = rfckt.lchighpasspi...  
        ('C',[1e-12 4e-12],'L',[2e-9 2.5e-9])
```

```
filter =
```

```
      Name: 'LC Highpass Pi'  
      nPort: 2  
      AnalyzedResult: []  
      L: [2x1 double]  
      C: [2x1 double]
```

## References

Ludwig, R. and P. Bretchko, *RF Circuit Design: Theory and Applications*, Prentice-Hall, 2000.

Zverev, A.I., *Handbook of Filter Synthesis*, John Wiley & Sons, 1967.

## See Also

```
rfckt.lcbandpasspi | rfckt.lcbandpasstee | rfckt.lcbandstoppi  
| rfckt.lcbandstoptee | rfckt.lchighpasstee |  
rfckt.lclowpasspi | rfckt.lclowpasstee
```



**Purpose** Highpass tee filter

**Syntax**  
`h = rfckt.lchighpasstee`  
`h = rfckt.lchighpasstee('Property1',value1,'Property2',value2, ...)`

**Description** Use the `lchighpasstee` class to represent a highpass tee filter as a network of inductors and capacitors.  
 The LC highpass tee network object is a 2-port network as shown in the following circuit diagram.

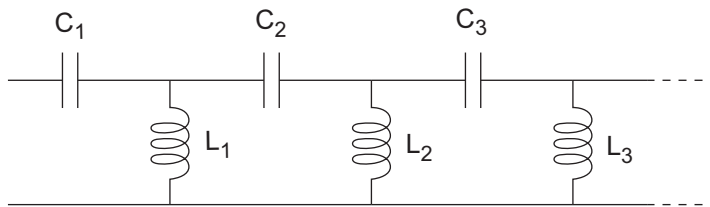

In the diagram,  $[L_1, L_2, L_3, \dots]$  is the value of the 'L' object property, and  $[C_1, C_2, C_3, \dots]$  is the value of the 'C' object property.

`h = rfckt.lchighpasstee` returns an LC highpass tee network object whose properties all have their default values.

`h = rfckt.lchighpasstee('Property1',value1,'Property2',value2, ...)` returns an LC highpass tee network object, `h`, based on the specified properties. Properties that you do not specify retain their default values.

<b>Properties</b>	AnalyzedResult	Computed S-parameters, noise figure, OIP3, and group delay values
	C	Capacitance data
	L	Inductance data

Name	Object name
nPort	Number of ports

## Methods

analyze	Analyze circuit object in frequency domain
analyze	Analyze circuit object in frequency domain
calculate	Calculate specified parameters for circuit object
calculate	Calculate specified parameters for circuit object
circle	Draw circles on Smith chart
circle	Draw circles on Smith chart
extract	Extract array of network parameters from data object
extract	Extract array of network parameters from data object
listformat	List valid formats for specified circuit object parameter
listformat	List valid formats for specified circuit object parameter
listparam	List valid parameters for specified circuit object
listparam	List valid parameters for specified circuit object
loglog	Plot specified circuit object parameters using log-log scale

loglog	Plot specified circuit object parameters using log-log scale
plot	Plot specified circuit object parameters on X-Y plane
plot	Plot specified circuit object parameters on X-Y plane
plotyy	Plot specified object parameters with $y$ -axes on both left and right sides
plotyy	Plot specified object parameters with $y$ -axes on both left and right sides
polar	Plot specified circuit object parameters on polar coordinates
polar	Plot specified circuit object parameters on polar coordinates
semilogx	Plot specified circuit object parameters using log scale for $x$ -axis
semilogx	Plot specified circuit object parameters using log scale for $x$ -axis
semilogy	Plot specified circuit object parameters using log scale for $x$ -axis
semilogy	Plot specified circuit object parameters using log scale for $x$ -axis
smith	Plot specified circuit object parameters on Smith chart

# rfckt.lchighpasstee

---

smith	Plot specified circuit object parameters on Smith chart
write	Write RF data from circuit or data object to file
write	Write RF data from circuit or data object to file

## Examples

```
filter = rfckt.lchighpasstee...  
        ('C',[1e-12 4e-12], 'L',[2e-9 2.5e-9])
```

```
filter =
```

```
Name: 'LC Highpass Tee'  
nPort: 2  
AnalyzedResult: []  
L: [2x1 double]  
C: [2x1 double]
```

## References

Ludwig, R. and P. Bretchko, *RF Circuit Design: Theory and Applications*, Prentice-Hall, 2000.

Zverev, A.I., *Handbook of Filter Synthesis*, John Wiley & Sons, 1967.

## See Also

```
rfckt.lcbandpasspi | rfckt.lcbandpasstee | rfckt.lcbandstoppi  
| rfckt.lcbandstoptee | rfckt.lchighpasspi | rfckt.lclowpasspi  
| rfckt.lclowpasstee
```

**Purpose** Lowpass pi filter

**Syntax**

```
h = rfckt.lclowpasspi
h = rfckt.lclowpasspi('Property1',value1,'Property2',value2,
    ...)
```

**Description** Use the `lclowpasspi` class to represent a lowpass pi filter as a network of inductors and capacitors.

The LC lowpass pi network object is a 2-port network as shown in the following circuit diagram.

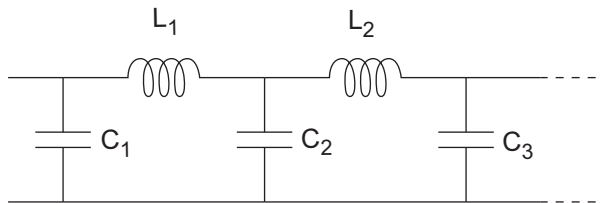

In the diagram,  $[L_1, L_2, L_3, \dots]$  is the value of the 'L' object property, and  $[C_1, C_2, C_3, \dots]$  is the value of the 'C' object property.

`h = rfckt.lclowpasspi` returns an LC lowpass pi network object whose properties all have their default values.

`h = rfckt.lclowpasspi('Property1',value1,'Property2',value2, ...)` returns an LC lowpass pi network object, `h`, based on the specified properties. Properties that you do not specify retain their default values.

<b>Properties</b>	AnalyzedResult	Computed S-parameters, noise figure, OIP3, and group delay values
	C	Capacitance data
	L	Inductance data

Name	Object name
nPort	Number of ports

## Methods

analyze	Analyze circuit object in frequency domain
analyze	Analyze circuit object in frequency domain
calculate	Calculate specified parameters for circuit object
calculate	Calculate specified parameters for circuit object
circle	Draw circles on Smith chart
circle	Draw circles on Smith chart
extract	Extract array of network parameters from data object
extract	Extract array of network parameters from data object
listformat	List valid formats for specified circuit object parameter
listformat	List valid formats for specified circuit object parameter
listparam	List valid parameters for specified circuit object
listparam	List valid parameters for specified circuit object
loglog	Plot specified circuit object parameters using log-log scale

---

loglog	Plot specified circuit object parameters using log-log scale
plot	Plot specified circuit object parameters on X-Y plane
plot	Plot specified circuit object parameters on X-Y plane
plotyy	Plot specified object parameters with $y$ -axes on both left and right sides
plotyy	Plot specified object parameters with $y$ -axes on both left and right sides
polar	Plot specified circuit object parameters on polar coordinates
polar	Plot specified circuit object parameters on polar coordinates
semilogx	Plot specified circuit object parameters using log scale for $x$ -axis
semilogx	Plot specified circuit object parameters using log scale for $x$ -axis
semilogy	Plot specified circuit object parameters using log scale for $x$ -axis
semilogy	Plot specified circuit object parameters using log scale for $x$ -axis
smith	Plot specified circuit object parameters on Smith chart

# rfckt.lclowpasspi

---

smith	Plot specified circuit object parameters on Smith chart
write	Write RF data from circuit or data object to file
write	Write RF data from circuit or data object to file

## Examples

```
filter = rfckt.lclowpasspi...  
        ('C',[1e-12 4e-12],'L',[2e-9 2.5e-9])
```

```
filter =
```

```
      Name: 'LC Lowpass Pi'  
      nPort: 2  
      AnalyzedResult: []  
      L: [2x1 double]  
      C: [2x1 double]
```

## References

Ludwig, R. and P. Bretchko, *RF Circuit Design: Theory and Applications*, Prentice-Hall, 2000.

Zverev, A.I., *Handbook of Filter Synthesis*, John Wiley & Sons, 1967.

## See Also

```
rfckt.lcbandpasspi | rfckt.lcbandpasstee | rfckt.lcbandstoppi  
| rfckt.lcbandstoptee | rfckt.lchighpasspi |  
rfckt.lchighpasstee | rfckt.lclowpasstee
```



**Purpose** Lowpass tee filter

**Syntax**

```
h = rfckt.lclowpasstee
h = rfckt.lclowpasstee('Property1',value1,'Property2',value2,
    ...)
```

**Description** Use the lclowpasstee class to represent a lowpass tee filter as a network of inductors and capacitors.

The LC lowpass tee network object is a 2-port network as shown in the following circuit diagram.

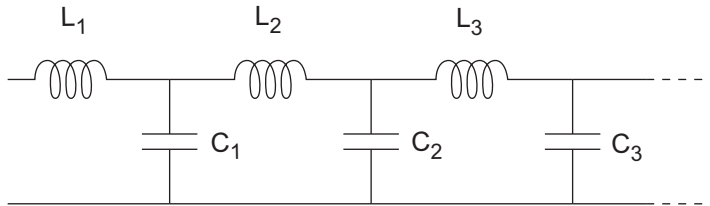

In the diagram,  $[L_1, L_2, L_3, \dots]$  is the value of the 'L' object property, and  $[C_1, C_2, C_3, \dots]$  is the value of the 'C' object property.

`h = rfckt.lclowpasstee` returns an LC lowpass tee network object whose properties all have their default values.

`h = rfckt.lclowpasstee('Property1',value1,'Property2',value2,...)` returns an LC lowpass tee network object, `h`, based on the specified properties. Properties that you do not specify retain their default values.

<b>Properties</b>	AnalyzedResult	Computed S-parameters, noise figure, OIP3, and group delay values
	C	Capacitance data
	L	Inductance data

Name	Object name
nPort	Number of ports

## Methods

analyze	Analyze circuit object in frequency domain
analyze	Analyze circuit object in frequency domain
calculate	Calculate specified parameters for circuit object
calculate	Calculate specified parameters for circuit object
circle	Draw circles on Smith chart
circle	Draw circles on Smith chart
extract	Extract array of network parameters from data object
extract	Extract array of network parameters from data object
listformat	List valid formats for specified circuit object parameter
listformat	List valid formats for specified circuit object parameter
listparam	List valid parameters for specified circuit object
listparam	List valid parameters for specified circuit object
loglog	Plot specified circuit object parameters using log-log scale

loglog	Plot specified circuit object parameters using log-log scale
plot	Plot specified circuit object parameters on X-Y plane
plot	Plot specified circuit object parameters on X-Y plane
plotyy	Plot specified object parameters with $y$ -axes on both left and right sides
plotyy	Plot specified object parameters with $y$ -axes on both left and right sides
polar	Plot specified circuit object parameters on polar coordinates
polar	Plot specified circuit object parameters on polar coordinates
semilogx	Plot specified circuit object parameters using log scale for $x$ -axis
semilogx	Plot specified circuit object parameters using log scale for $x$ -axis
semilogy	Plot specified circuit object parameters using log scale for $x$ -axis
semilogy	Plot specified circuit object parameters using log scale for $x$ -axis
smith	Plot specified circuit object parameters on Smith chart

# rfckt.lclowpasstee

---

smith	Plot specified circuit object parameters on Smith chart
write	Write RF data from circuit or data object to file
write	Write RF data from circuit or data object to file

## Examples

```
filter = rfckt.lclowpasstee...  
        ('C',[1e-12 4e-12], 'L',[2e-9 2.5e-9])
```

```
filter =
```

```
      Name: 'LC Lowpass Tee'  
      nPort: 2  
      AnalyzedResult: []  
      L: [2x1 double]  
      C: [2x1 double]
```

## References

Ludwig, R. and P. Bretchko, *RF Circuit Design: Theory and Applications*, Prentice-Hall, 2000.

Zverev, A.I., *Handbook of Filter Synthesis*, John Wiley & Sons, 1967.

## See Also

```
rfckt.lcbandpasspi | rfckt.lcbandpasstee | rfckt.lcbandstoppi  
| rfckt.lcbandstoptee | rfckt.lchighpasspi |  
rfckt.lchighpasstee | rfckt.lclowpasspi
```

**Purpose** Microstrip transmission line

**Syntax**

```
h = rfckt.microstrip
h = rfckt.microstrip('Property1',value1,'Property2',value2,
    ...)
```

**Description** Use the microstrip class to represent microstrip transmission lines that are characterized by line dimensions and optional stub properties.

A microstrip transmission line is shown in cross-section in the following figure. Its physical characteristics include the microstrip width ( $w$ ), the microstrip thickness ( $t$ ), the substrate height ( $d$ ), and the relative permittivity constant ( $\epsilon$ ).

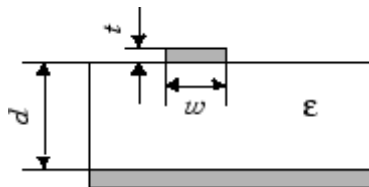

`h = rfckt.microstrip` returns a microstrip transmission line object whose properties are set to their default values.

`h = rfckt.microstrip('Property1',value1,'Property2',value2,...)` returns a microstrip transmission line object, `h`, with the specified properties. Properties that you do not specify retain their default values.

## Properties

AnalyzedResult	Computed S-parameters, noise figure, OIP3, and group delay values
EpsilonR	Relative permittivity of dielectric
Height	Dielectric thickness
LineLength	Microstrip line length

LossTangent	Tangent of loss angle
Name	Object name
nPort	Number of ports
SigmaCond	Conductor conductivity
StubMode	Type of stub
Termination	Stub transmission line termination
Thickness	Microstrip thickness
Width	Parallel-plate width

## Methods

analyze	Analyze circuit object in frequency domain
analyze	Analyze circuit object in frequency domain
calculate	Calculate specified parameters for circuit object
calculate	Calculate specified parameters for circuit object
circle	Draw circles on Smith chart
circle	Draw circles on Smith chart
getz0	Characteristic impedance of transmission line object
getz0	Characteristic impedance of transmission line object
listformat	List valid formats for specified circuit object parameter

listformat	List valid formats for specified circuit object parameter
listparam	List valid parameters for specified circuit object
listparam	List valid parameters for specified circuit object
loglog	Plot specified circuit object parameters using log-log scale
loglog	Plot specified circuit object parameters using log-log scale
plot	Plot specified circuit object parameters on X-Y plane
plot	Plot specified circuit object parameters on X-Y plane
plotyy	Plot specified object parameters with y-axes on both left and right sides
plotyy	Plot specified object parameters with y-axes on both left and right sides
polar	Plot specified circuit object parameters on polar coordinates
polar	Plot specified circuit object parameters on polar coordinates
semilogx	Plot specified circuit object parameters using log scale for x-axis
semilogx	Plot specified circuit object parameters using log scale for x-axis

semilogy	Plot specified circuit object parameters using log scale for $x$ -axis
semilogy	Plot specified circuit object parameters using log scale for $x$ -axis
smith	Plot specified circuit object parameters on Smith chart
smith	Plot specified circuit object parameters on Smith chart
write	Write RF data from circuit or data object to file
write	Write RF data from circuit or data object to file

## Examples

```
tx1=rfckt.microstrip('Thickness',0.0075e-6)
```

```
tx1 =
```

```
Name: 'Microstrip Transmission Line'  
nPort: 2  
AnalyzedResult: []  
LineLength: 0.0100  
StubMode: 'NotAStub'  
Termination: 'NotApplicable'  
Width: 6.0000e-004  
Height: 6.3500e-004  
Thickness: 7.5000e-009  
EpsilonR: 9.8000  
SigmaCond: Inf  
LossTangent: 0
```

## References

[1] Gupta, K. C., R. Garg, I. Bahl, and P. Bhartia, *Microstrip Lines and Slotlines*, 2nd Edition, Artech House, Inc., Norwood, MA, 1996.



**See Also**

rfckt.coaxial | rfckt.cpw | rfckt.parallelplate |  
rfckt.rlcgline | rfckt.twowire | rfckt.txline

# rfckt.mixer

---

**Purpose** 2-port representation of RF mixer and its local oscillator

**Syntax**  
`h = rfckt.mixer`  
`h = rfckt.mixer('Property1',value1,'Property2',value2,...)`

**Description** Use the mixer class to represent RF mixers and their local oscillators that are characterized by network parameters, noise data, nonlinearity data, and local oscillator frequency.

`h = rfckt.mixer` returns a mixer object whose properties all have their default values.

`h = rfckt.mixer('Property1',value1,'Property2',value2,...)` returns a circuit object, `h`, that represents a mixer and its local oscillator (LO) with two ports (RF and IF). Properties that you do not specify retain their default values.

Use the `read` method to read the mixer data from a data file in one of the following formats:

- Touchstone
- Agilent P2D
- Agilent S2D
- AMP

See Appendix A, “AMP File Format” for information about the `.amp` format.

<b>Properties</b>	AnalyzedResult	Computed S-parameters, noise figure, OIP3, and group delay values
	FLO	Local oscillator frequency
	FreqOffset	Frequency offset data
	IntpType	Interpolation method

MixerSpurData	Data from mixer spur table
MixerType	Type of mixer
Name	Object name
NetworkData	Network parameter information
NoiseData	Noise information
NonlinearData	Nonlinearity information
nPort	Number of ports
PhaseNoiseLevel	Phase noise data

## Methods

analyze	Analyze circuit object in frequency domain
analyze	Analyze circuit object in frequency domain
calculate	Calculate specified parameters for circuit object
calculate	Calculate specified parameters for circuit object
circle	Draw circles on Smith chart
circle	Draw circles on Smith chart
extract	Extract array of network parameters from data object
extract	Extract array of network parameters from data object
getop	Display operating conditions
getop	Display operating conditions
listformat	List valid formats for specified circuit object parameter

listformat	List valid formats for specified circuit object parameter
listparam	List valid parameters for specified circuit object
listparam	List valid parameters for specified circuit object
loglog	Plot specified circuit object parameters using log-log scale
loglog	Plot specified circuit object parameters using log-log scale
plot	Plot specified circuit object parameters on X-Y plane
plot	Plot specified circuit object parameters on X-Y plane
plotyy	Plot specified object parameters with y-axes on both left and right sides
plotyy	Plot specified object parameters with y-axes on both left and right sides
polar	Plot specified circuit object parameters on polar coordinates
polar	Plot specified circuit object parameters on polar coordinates
read	Read RF data from file to new or existing circuit or data object
read	Read RF data from file to new or existing circuit or data object
restore	Restore data to original frequencies

restore	Restore data to original frequencies
semilogx	Plot specified circuit object parameters using log scale for <i>x</i> -axis
semilogx	Plot specified circuit object parameters using log scale for <i>x</i> -axis
semilogy	Plot specified circuit object parameters using log scale for <i>x</i> -axis
semilogy	Plot specified circuit object parameters using log scale for <i>x</i> -axis
smith	Plot specified circuit object parameters on Smith chart
smith	Plot specified circuit object parameters on Smith chart
write	Write RF data from circuit or data object to file
write	Write RF data from circuit or data object to file

## Examples

```
mix1 = rfckt.mixer('IntpType','cubic')
```

```
mix1 =
```

```

Name: 'Mixer'
nPort: 2
AnalyzedResult: [1x1 rfdata.data]
IntpType: 'Cubic'
NetworkData: [1x1 rfdata.network]
```

```
NoiseData: [1x1 rfddata.noise]  
NonlinearData: Inf  
MixerSpurData: []  
MixerType: 'Downconverter'  
FLO: 1.0000e+009  
FreqOffset: []  
PhaseNoiseLevel: []
```

## References

EIA/IBIS Open Forum, *Touchstone File Format Specification*, Rev. 1.1, 2002  
([http://www.vhdl.org/pub/ibis/connector/touchstone\\_spec11.pdf](http://www.vhdl.org/pub/ibis/connector/touchstone_spec11.pdf)).

## See Also

rfckt.amplifier | rfckt.datafile | rfckt.passive  
| rfddata.data | rfddata.ip3 | rfddata.mixerspurs |  
rfddata.network | rfddata.nf | rfddata.noise | rfddata.power |  
[http://www.vhdl.org/pub/ibis/connector/touchstone\\_spec11.pdf](http://www.vhdl.org/pub/ibis/connector/touchstone_spec11.pdf)

**Purpose** Parallel connected network

**Syntax**  
`h = rfckt.parallel`  
`h = rfckt.parallel('Property1',value1,'Property2',value2,...)`

**Description** Use the `parallel` class to represent networks of linear RF objects connected in parallel that are characterized by the components that make up the network. The following figure shows a pair of networks in a parallel configuration.

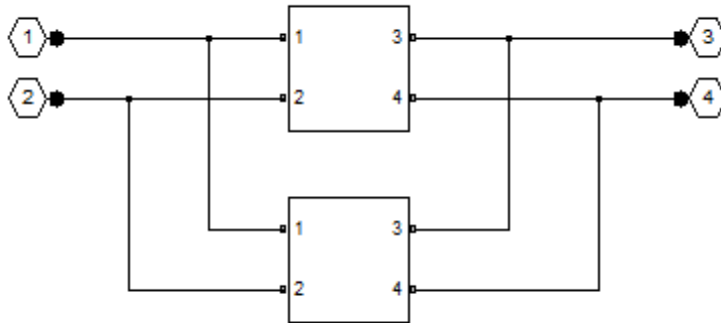

`h = rfckt.parallel` returns a parallel connected network object whose properties all have their default values.

`h = rfckt.parallel('Property1',value1,'Property2',value2,...)` returns a parallel connected network object, `h`, based on the specified properties. Properties that you do not specify retain their default values.

## Properties

AnalyzedResult	Computed S-parameters, noise figure, OIP3, and group delay values
Ckts	Circuit objects in network
Name	Object name
nPort	Number of ports

## Methods

analyze	Analyze circuit object in frequency domain
analyze	Analyze circuit object in frequency domain
calculate	Calculate specified parameters for circuit object
calculate	Calculate specified parameters for circuit object
circle	Draw circles on Smith chart
circle	Draw circles on Smith chart
listformat	List valid formats for specified circuit object parameter
listformat	List valid formats for specified circuit object parameter
listparam	List valid parameters for specified circuit object
listparam	List valid parameters for specified circuit object
loglog	Plot specified circuit object parameters using log-log scale



---

loglog	Plot specified circuit object parameters using log-log scale
plot	Plot specified circuit object parameters on X-Y plane
plot	Plot specified circuit object parameters on X-Y plane
plotyy	Plot specified object parameters with $y$ -axes on both left and right sides
plotyy	Plot specified object parameters with $y$ -axes on both left and right sides
polar	Plot specified circuit object parameters on polar coordinates
polar	Plot specified circuit object parameters on polar coordinates
semilogx	Plot specified circuit object parameters using log scale for $x$ -axis
semilogx	Plot specified circuit object parameters using log scale for $x$ -axis
semilogy	Plot specified circuit object parameters using log scale for $x$ -axis
semilogy	Plot specified circuit object parameters using log scale for $x$ -axis
smith	Plot specified circuit object parameters on Smith chart

# rfckt.parallel

---

smith	Plot specified circuit object parameters on Smith chart
write	Write RF data from circuit or data object to file
write	Write RF data from circuit or data object to file

## Examples

```
tx1 = rfckt.txline;  
tx2 = rfckt.txline;  
ple1 = rfckt.parallel('Ckts',{tx1,tx2})
```

```
ple1 =
```

```
      Name: 'Parallel Connected Network'  
      nPort: 2  
      AnalyzedResult: []  
      Ckts: {1x2 cell}
```

## References

Ludwig, R. and P. Bretchko, *RF Circuit Design: Theory and Applications*, Prentice-Hall, 2000.

## See Also

[rfckt.cascade](#) | [rfckt.hybrid](#) | [rfckt.hybridg](#) | [rfckt.series](#)

**Purpose** Parallel-plate transmission line

**Syntax**

```
h = rfckt.parallelplate
h = rfckt.parallelplate('Property1',value1,'Property2',value2,
    ...)
```

**Description** Use the `parallelplate` class to represent parallel-plate transmission lines that are characterized by line dimensions and optional stub properties.

A parallel-plate transmission line is shown in cross-section in the following figure. Its physical characteristics include the plate width  $w$  and the plate separation  $d$ .

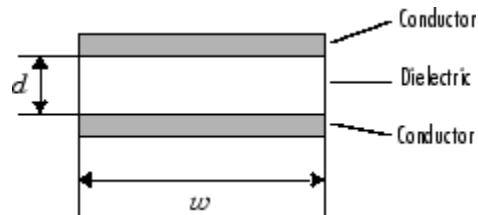

`h = rfckt.parallelplate` returns a parallel-plate transmission line object whose properties are set to their default values.

`h = rfckt.parallelplate('Property1',value1,'Property2',value2,...)` returns a parallel-plate transmission line object, `h`, with the specified properties. Properties that you do not specify retain their default values.

## Properties

AnalyzedResult	Computed S-parameters, noise figure, OIP, and group delay values
EpsilonR	Relative permittivity of dielectric
LineLength	Parallel-plate line length

LossTangent	Tangent of loss angle
MuR	Relative permeability of dielectric
Name	Object name
nPort	Number of ports
Separation	Distance between plates
SigmaCond	Conductor conductivity
StubMode	Type of stub
Termination	Stub transmission line termination
Width	Transmission line width

## Methods

analyze	Analyze circuit object in frequency domain
analyze	Analyze circuit object in frequency domain
calculate	Calculate specified parameters for circuit object
calculate	Calculate specified parameters for circuit object
circle	Draw circles on Smith chart
circle	Draw circles on Smith chart
getz0	Characteristic impedance of transmission line object
getz0	Characteristic impedance of transmission line object
listformat	List valid formats for specified circuit object parameter

listformat	List valid formats for specified circuit object parameter
listparam	List valid parameters for specified circuit object
listparam	List valid parameters for specified circuit object
loglog	Plot specified circuit object parameters using log-log scale
loglog	Plot specified circuit object parameters using log-log scale
plot	Plot specified circuit object parameters on X-Y plane
plot	Plot specified circuit object parameters on X-Y plane
plotyy	Plot specified object parameters with <i>y</i> -axes on both left and right sides
plotyy	Plot specified object parameters with <i>y</i> -axes on both left and right sides
polar	Plot specified circuit object parameters on polar coordinates
polar	Plot specified circuit object parameters on polar coordinates
semilogx	Plot specified circuit object parameters using log scale for <i>x</i> -axis
semilogx	Plot specified circuit object parameters using log scale for <i>x</i> -axis

semilogy	Plot specified circuit object parameters using log scale for $x$ -axis
semilogy	Plot specified circuit object parameters using log scale for $x$ -axis
smith	Plot specified circuit object parameters on Smith chart
smith	Plot specified circuit object parameters on Smith chart
write	Write RF data from circuit or data object to file
write	Write RF data from circuit or data object to file

## Examples

```
tx1=rfckt.parallelplate('LineLength',0.045)
```

```
tx1 =
```

```
Name: 'Parallel-Plate Transmission Line'  
nPort: 2  
AnalyzedResult: []  
LineLength: 0.0450  
StubMode: 'NotAStub'  
Termination: 'NotApplicable'  
Width: 0.0050  
Separation: 1.0000e-003  
MuR: 1  
EpsilonR: 2.3000  
LossTangent: 0  
SigmaCond: Inf
```

## References

Pozar, David M. *Microwave Engineering*, John Wiley & Sons, Inc., 2005.

**See Also**

[rfckt.coaxial](#) | [rfckt.cpw](#) | [rfckt.microstrip](#) | [rfckt.rlogline](#) |  
[rfckt.twowire](#) | [rfckt.txline](#)

# rfckt.passive

---

**Purpose** Passive component or network

**Syntax**  
`h = rfckt.passive`  
`h = rfckt.passive('Property1',value1,'Property2',value2,...)`

**Description** Use the `passive` class to represent passive RF components and networks that are characterized by passive network parameter data.

`h = rfckt.passive` returns an passive-device object whose properties all have their default values.

`h = rfckt.passive('Property1',value1,'Property2',value2,...)` returns a circuit object, `h`, based on the specified properties. Properties that you do not specify retain their default values.

Use the `read` method to read the passive object data from a Touchstone data file. When you read S-parameter data into an `rfckt.passive` object, the magnitude of your  $S_{21}$  data must be less than or equal to 1.

Due to random numerical error, data measured from a passive device is not necessarily passive. However, `rfckt.passive` objects can only contain passive data. To import data with active regions, use the `rfckt.amplifier` object, even if the original data represents a passive device.

<b>Properties</b>	AnalyzedResult	Computed S-parameters, noise figure, OIP3, and group delay values
	IntpType	Interpolation method
	Name	Object name
	NetworkData	Network parameter information
	nPort	Number of ports



**Methods**

analyze	Analyze circuit object in frequency domain
analyze	Analyze circuit object in frequency domain
calculate	Calculate specified parameters for circuit object
calculate	Calculate specified parameters for circuit object
circle	Draw circles on Smith chart
circle	Draw circles on Smith chart
extract	Extract array of network parameters from data object
extract	Extract array of network parameters from data object
listformat	List valid formats for specified circuit object parameter
listformat	List valid formats for specified circuit object parameter
listparam	List valid parameters for specified circuit object
listparam	List valid parameters for specified circuit object
loglog	Plot specified circuit object parameters using log-log scale
loglog	Plot specified circuit object parameters using log-log scale
plot	Plot specified circuit object parameters on X-Y plane

plot	Plot specified circuit object parameters on X-Y plane
plotyy	Plot specified object parameters with <i>y</i> -axes on both left and right sides
plotyy	Plot specified object parameters with <i>y</i> -axes on both left and right sides
polar	Plot specified circuit object parameters on polar coordinates
polar	Plot specified circuit object parameters on polar coordinates
read	Read RF data from file to new or existing circuit or data object
read	Read RF data from file to new or existing circuit or data object
restore	Restore data to original frequencies
restore	Restore data to original frequencies
semilogx	Plot specified circuit object parameters using log scale for <i>x</i> -axis
semilogx	Plot specified circuit object parameters using log scale for <i>x</i> -axis
semilogy	Plot specified circuit object parameters using log scale for <i>x</i> -axis

semilogy	Plot specified circuit object parameters using log scale for <i>x</i> -axis
smith	Plot specified circuit object parameters on Smith chart
smith	Plot specified circuit object parameters on Smith chart
write	Write RF data from circuit or data object to file
write	Write RF data from circuit or data object to file

## Examples

```
pas = rfckt.passive('IntpType','cubic')

pas =

    Name: 'Passive'
    nPort: 2
    AnalyzedResult: [1x1 rfddata.data]
    IntpType: 'Cubic'
    NetworkData: [1x1 rfddata.network]
```

## References

EIA/IBIS Open Forum, *Touchstone File Format Specification*, Rev. 1.1, 2002  
 ([http://www.vhdl.org/pub/ibis/connector/touchstone\\_spec11.pdf](http://www.vhdl.org/pub/ibis/connector/touchstone_spec11.pdf)).

## See Also

rfckt.amplifier | rfckt.datafile |  
 rfckt.mixer | rfddata.data | rfddata.network |  
[http://www.vhdl.org/pub/ibis/connector/touchstone\\_spec11.pdf](http://www.vhdl.org/pub/ibis/connector/touchstone_spec11.pdf)

# rfckt.rlcgline

---

**Purpose** RLCG transmission line

**Syntax**  
`h = rfckt.rlcgline`  
`h = rfckt.rlcgline('Property1',value1,'Property2',value2,...)`

**Description** Use the `rlcgline` class to represent RLCG transmission lines that are characterized by line loss, line length, stub type, and termination.

`h = rfckt.rlcgline` returns an RLCG transmission line object whose properties are set to their default values.

`h = rfckt.rlcgline('Property1',value1,'Property2',value2,...)` returns an RLCG transmission line object, `h`, with the specified properties. Properties that you do not specify retain their default values.

<b>Properties</b>	AnalyzedResult	Computed S-parameters, noise figure, OIP3, and group delay values
	C	Capacitance data
	Freq	Frequency data
	G	Conductance data
	IntpType	Interpolation method
	L	Inductance data
	LineLength	Transmission line length
	Name	Object name
	nPort	Number of ports
	R	Resistance data
	StubMode	Type of stub
	Termination	Stub transmission line termination

**Methods**

analyze	Analyze circuit object in frequency domain
analyze	Analyze circuit object in frequency domain
calculate	Calculate specified parameters for circuit object
calculate	Calculate specified parameters for circuit object
circle	Draw circles on Smith chart
circle	Draw circles on Smith chart
getz0	Characteristic impedance of transmission line object
getz0	Characteristic impedance of transmission line object
listformat	List valid formats for specified circuit object parameter
listformat	List valid formats for specified circuit object parameter
listparam	List valid parameters for specified circuit object
listparam	List valid parameters for specified circuit object
loglog	Plot specified circuit object parameters using log-log scale
loglog	Plot specified circuit object parameters using log-log scale
plot	Plot specified circuit object parameters on X-Y plane

plot	Plot specified circuit object parameters on X-Y plane
plotyy	Plot specified object parameters with y-axes on both left and right sides
plotyy	Plot specified object parameters with y-axes on both left and right sides
polar	Plot specified circuit object parameters on polar coordinates
polar	Plot specified circuit object parameters on polar coordinates
semilogx	Plot specified circuit object parameters using log scale for x-axis
semilogx	Plot specified circuit object parameters using log scale for x-axis
semilogy	Plot specified circuit object parameters using log scale for x-axis
semilogy	Plot specified circuit object parameters using log scale for x-axis
smith	Plot specified circuit object parameters on Smith chart
smith	Plot specified circuit object parameters on Smith chart

write Write RF data from circuit or data object to file

write Write RF data from circuit or data object to file

## Examples

```
tx1=rfckt.rlcgline('R',0.002,'C',8.8542e-12,...
                  'L',1.2566e-6,'G',0.002')
```

```
tx1 =
```

```
Name: 'RLCG Transmission Line'
nPort: 2
AnalyzedResult: []
LineLength: 0.0100
StubMode: 'NotAStub'
Termination: 'NotApplicable'
Freq: 1.0000e+009
R: 0.0020
L: 1.2566e-006
C: 8.8542e-012
G: 0.0020
IntpType: 'Linear'
```

## References

Ludwig, R. and P. Bretchko, *RF Circuit Design: Theory and Applications*, Prentice-Hall, 2000.

## See Also

rfckt.coaxial | rfckt.cpw | rfckt.microstrip |  
 rfckt.parallelplate | rfckt.twowire | rfckt.txline

# rfckt.series

**Purpose** Series connected network

**Syntax**  
`h = rfckt.series`  
`h = rfckt.series('Property1',value1,'Property2',value2,...)`

**Description** Use the `series` class to represent networks of linear RF objects connected in series that are characterized by the components that make up the network. The following figure shows a pair of networks in a series configuration.

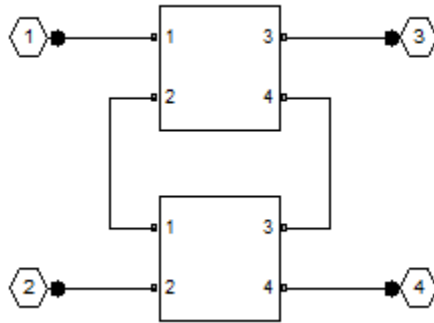

`h = rfckt.series` returns a series connected network object whose properties all have their default values.

`h = rfckt.series('Property1',value1,'Property2',value2,...)` returns a series connected network object, `h`, based on the specified properties. Properties that you do not specify retain their default values.

## Properties

AnalyzedResult	Computed S-parameters, noise figure, OIP3, and group delay values
Ckts	Circuit objects in network



Name	Object name
nPort	Number of ports
<b>Methods</b>	
analyze	Analyze circuit object in frequency domain
analyze	Analyze circuit object in frequency domain
calculate	Calculate specified parameters for circuit object
calculate	Calculate specified parameters for circuit object
circle	Draw circles on Smith chart
circle	Draw circles on Smith chart
listformat	List valid formats for specified circuit object parameter
listformat	List valid formats for specified circuit object parameter
listparam	List valid parameters for specified circuit object
listparam	List valid parameters for specified circuit object
loglog	Plot specified circuit object parameters using log-log scale
loglog	Plot specified circuit object parameters using log-log scale
plot	Plot specified circuit object parameters on X-Y plane

plot	Plot specified circuit object parameters on X-Y plane
plotyy	Plot specified object parameters with y-axes on both left and right sides
plotyy	Plot specified object parameters with y-axes on both left and right sides
polar	Plot specified circuit object parameters on polar coordinates
polar	Plot specified circuit object parameters on polar coordinates
semilogx	Plot specified circuit object parameters using log scale for x-axis
semilogx	Plot specified circuit object parameters using log scale for x-axis
semilogy	Plot specified circuit object parameters using log scale for x-axis
semilogy	Plot specified circuit object parameters using log scale for x-axis
smith	Plot specified circuit object parameters on Smith chart
smith	Plot specified circuit object parameters on Smith chart

`write` Write RF data from circuit or data object to file

`write` Write RF data from circuit or data object to file

## Examples

```
tx1 = rfckt.txline;  
tx2 = rfckt.txline;  
ser = rfckt.series('Ckts',{tx1,tx2})
```

```
ser =
```

```
Name: 'Series Connected Network'  
nPort: 2  
AnalyzedResult: []  
Ckts: {1x2 cell}
```

## References

Ludwig, Reinhold and Pavel Bretchko, *RF Circuit Design: Theory and Applications*, Prentice-Hall, 2000.

## See Also

`rfckt.cascade` | `rfckt.hybrid` | `rfckt.hybridg` | `rfckt.parallel`

# rfckt.seriesrlc

---

**Purpose** Series RLC component

**Syntax**  
`h = rfckt.seriesrlc`  
`h = rfckt.seriesrlc('R',Rvalue,'L',Lvalue,'C',Cvalue)`

**Description** Use the `seriesrlc` class to represent a component as a resistor, inductor, and capacitor connected in series.  
The series RLC network object is a 2-port network as shown in the following circuit diagram.

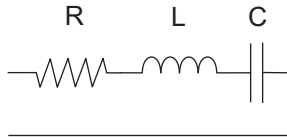

`h = rfckt.seriesrlc` returns a series RLC network object whose properties all have their default values. The default object is equivalent to a pass-through 2-port network, i.e., the resistor, inductor, and capacitor are each replaced by a short circuit.

`h = rfckt.seriesrlc('R',Rvalue,'L',Lvalue,'C',Cvalue)` returns a series RLC network object, `h`, based on the specified resistance (R), inductance (L), and capacitance (C) values. Properties that you do not specify retain their default values, allowing you to specify a network of a single resistor, inductor, or capacitor.

<b>Properties</b>	AnalyzedResult	Computed S-parameters, noise figure, OIP3, and group delay values
	C	Capacitance value
	L	Inductance value
	Name	Object name

nPort	Number of ports
R	Resistance value

## Methods

analyze	Analyze circuit object in frequency domain
analyze	Analyze circuit object in frequency domain
calculate	Calculate specified parameters for circuit object
calculate	Calculate specified parameters for circuit object
circle	Draw circles on Smith chart
circle	Draw circles on Smith chart
extract	Extract array of network parameters from data object
extract	Extract array of network parameters from data object
listformat	List valid formats for specified circuit object parameter
listformat	List valid formats for specified circuit object parameter
listparam	List valid parameters for specified circuit object
listparam	List valid parameters for specified circuit object
loglog	Plot specified circuit object parameters using log-log scale

loglog	Plot specified circuit object parameters using log-log scale
plot	Plot specified circuit object parameters on X-Y plane
plot	Plot specified circuit object parameters on X-Y plane
plotyy	Plot specified object parameters with <i>y</i> -axes on both left and right sides
plotyy	Plot specified object parameters with <i>y</i> -axes on both left and right sides
polar	Plot specified circuit object parameters on polar coordinates
polar	Plot specified circuit object parameters on polar coordinates
semilogx	Plot specified circuit object parameters using log scale for <i>x</i> -axis
semilogx	Plot specified circuit object parameters using log scale for <i>x</i> -axis
semilogy	Plot specified circuit object parameters using log scale for <i>x</i> -axis
semilogy	Plot specified circuit object parameters using log scale for <i>x</i> -axis
smith	Plot specified circuit object parameters on Smith chart

---

smith	Plot specified circuit object parameters on Smith chart
write	Write RF data from circuit or data object to file
write	Write RF data from circuit or data object to file

## Examples

This example creates a series LC resonator and examines its frequency response. It first creates the circuit object and then uses the `analyze` method to calculate its frequency response. Finally, it plots the results — first, the magnitude in decibels (dB):

```
h = rfckt.seriesrlc('L',4.7e-5,'C',2.2e-10);  
analyze(h,logspace(4,8,1000));  
plot(h,'s21','dB')  
set(gca,'Xscale','log')
```

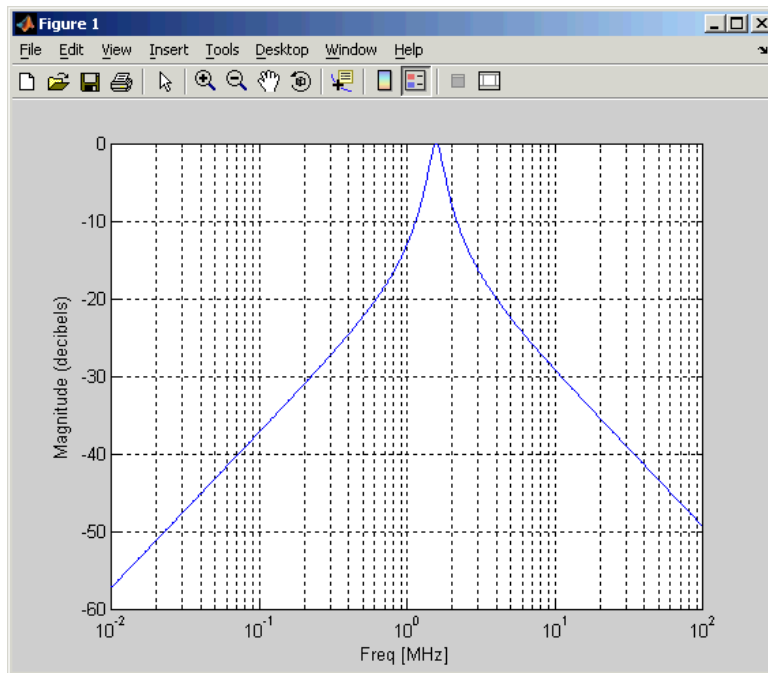

The example then plots the phase, in degrees:

```
figure
plot(h, 's21', 'angle')
set(gca, 'Xscale', 'log')
```



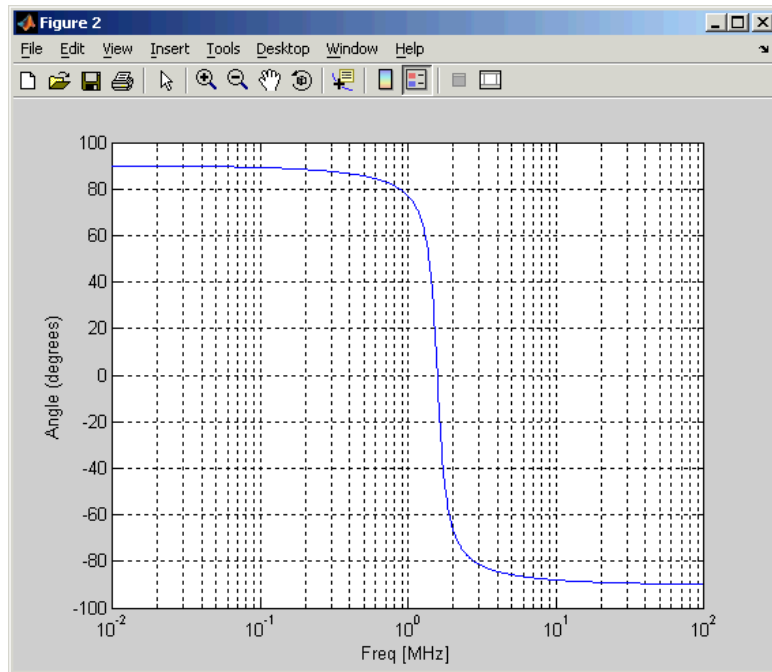

## References

Ludwig, Reinhold and Pavel Bretchko, *RF Circuit Design: Theory and Applications*, Prentice-Hall, 2000.

## See Also

rfckt.shuntrlc

# rfckt.shuntrlc

---

**Purpose** Shunt RLC component

**Syntax**  
`h = rfckt.shuntrlc`  
`h = rfckt.shuntrlc('R',Rvalue,'L',Lvalue,'C',Cvalue)`

**Description** Use the `shuntrlc` class to represent a component as a resistor, inductor, and capacitor connected in a shunt configuration.

The shunt RLC network object is a 2-port network as shown in the following circuit diagram.

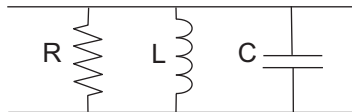

`h = rfckt.shuntrlc` returns a shunt RLC network object whose properties all have their default values. The default object is equivalent to a pass-through 2-port network; i.e., the resistor, inductor, and capacitor are each replaced by a short circuit.

`h = rfckt.shuntrlc('R',Rvalue,'L',Lvalue,'C',Cvalue)` returns a shunt RLC network object, `h`, based on the specified resistance (`R`), inductance (`L`), and capacitance (`C`) values. Properties that you do not specify retain their default values, allowing you to specify a network of a single resistor, inductor, or capacitor.

<b>Properties</b>	AnalyzedResult	Computed S-parameters, noise figure, OIP3, and group delay values
	C	Capacitance value
	L	Inductance value
	Name	Object name

nPort	Number of ports
R	Resistance value

## Methods

analyze	Analyze circuit object in frequency domain
analyze	Analyze circuit object in frequency domain
calculate	Calculate specified parameters for circuit object
calculate	Calculate specified parameters for circuit object
circle	Draw circles on Smith chart
circle	Draw circles on Smith chart
extract	Extract array of network parameters from data object
extract	Extract array of network parameters from data object
listformat	List valid formats for specified circuit object parameter
listformat	List valid formats for specified circuit object parameter
listparam	List valid parameters for specified circuit object
listparam	List valid parameters for specified circuit object
loglog	Plot specified circuit object parameters using log-log scale

loglog	Plot specified circuit object parameters using log-log scale
plot	Plot specified circuit object parameters on X-Y plane
plot	Plot specified circuit object parameters on X-Y plane
plotyy	Plot specified object parameters with <i>y</i> -axes on both left and right sides
plotyy	Plot specified object parameters with <i>y</i> -axes on both left and right sides
polar	Plot specified circuit object parameters on polar coordinates
polar	Plot specified circuit object parameters on polar coordinates
semilogx	Plot specified circuit object parameters using log scale for <i>x</i> -axis
semilogx	Plot specified circuit object parameters using log scale for <i>x</i> -axis
semilogy	Plot specified circuit object parameters using log scale for <i>x</i> -axis
semilogy	Plot specified circuit object parameters using log scale for <i>x</i> -axis
smith	Plot specified circuit object parameters on Smith chart

---

smith	Plot specified circuit object parameters on Smith chart
write	Write RF data from circuit or data object to file
write	Write RF data from circuit or data object to file

## Examples

This example creates a shunt LC resonator and examines its frequency response. It first creates the circuit object and then uses the `analyze` method to calculate its frequency response. Finally, it plots the results — first, the magnitude in decibels (dB):

```
h = rfckt.shuntrlc('L',4.7e-5,'C',2.2e-10);
analyze(h,logspace(4,8,1000));
plot(h,'s21','dB')
set(gca,'Xscale','log')
```

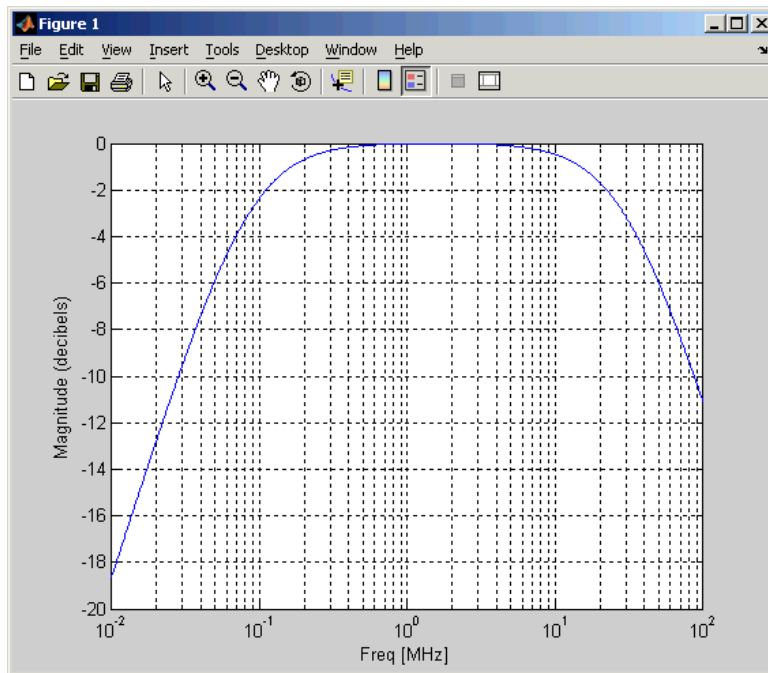

The example then plots the phase, in degrees:

```
figure  
plot(h, 's21', 'angle')  
set(gca, 'Xscale', 'log')
```

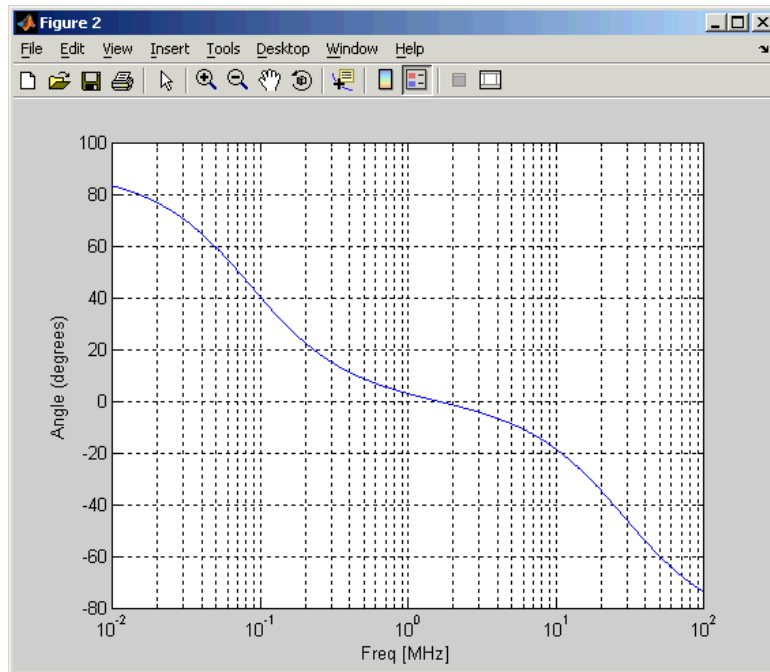

## References

Ludwig, Reinhold and Pavel Bretchko, *RF Circuit Design: Theory and Applications*, Prentice-Hall, 2000.

## See Also

rfckt.seriesrlc

**Purpose** Two-wire transmission line

**Syntax**  
`h = rfckt.twowire`  
`h = rfckt.twowire('Property1',value1,'Property2',value2,...)`

**Description** Use the `twowire` class to represent two-wire transmission lines that are characterized by line dimensions, stub type, and termination.

A two-wire transmission line is shown in cross-section in the following figure. Its physical characteristics include the radius of the wires  $a$ , the separation or physical distance between the wire centers  $S$ , and the relative permittivity and permeability of the wires. RF Toolbox software assumes the relative permittivity and permeability are uniform.

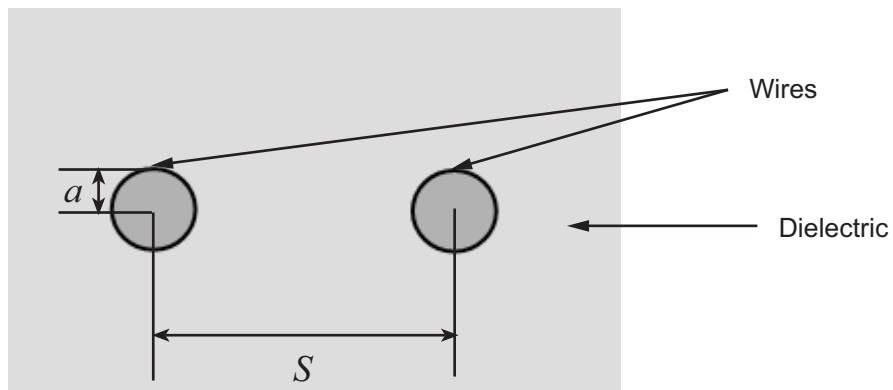

`h = rfckt.twowire` returns a two-wire transmission line object whose properties are set to their default values.

`h = rfckt.twowire('Property1',value1,'Property2',value2,...)` returns a two-wire transmission line object, `h`, with the specified properties. Properties that you do not specify retain their default values.



## Construction

### Properties

AnalyzedResult	Computed S-parameters, noise figure, OIP3, and group delay values
EpsilonR	Relative permittivity of dielectric
LineLength	Transmission line length
LossTangent	Tangent of loss angle
MuR	Relative permeability of dielectric
Name	Object name
nPort	Number of ports
Radius	Wire radius
Separation	Distance between wires
SigmaCond	Conductor conductivity
StubMode	Type of stub
Termination	Stub transmission line termination

### Methods

analyze	Analyze circuit object in frequency domain
analyze	Analyze circuit object in frequency domain
calculate	Calculate specified parameters for circuit object
calculate	Calculate specified parameters for circuit object
circle	Draw circles on Smith chart

circle	Draw circles on Smith chart
getz0	Characteristic impedance of transmission line object
getz0	Characteristic impedance of transmission line object
listformat	List valid formats for specified circuit object parameter
listformat	List valid formats for specified circuit object parameter
listparam	List valid parameters for specified circuit object
listparam	List valid parameters for specified circuit object
loglog	Plot specified circuit object parameters using log-log scale
loglog	Plot specified circuit object parameters using log-log scale
plot	Plot specified circuit object parameters on X-Y plane
plot	Plot specified circuit object parameters on X-Y plane
plotyy	Plot specified object parameters with y-axes on both left and right sides
plotyy	Plot specified object parameters with y-axes on both left and right sides
polar	Plot specified circuit object parameters on polar coordinates

polar	Plot specified circuit object parameters on polar coordinates
semilogx	Plot specified circuit object parameters using log scale for <i>x</i> -axis
semilogx	Plot specified circuit object parameters using log scale for <i>x</i> -axis
semilogy	Plot specified circuit object parameters using log scale for <i>x</i> -axis
semilogy	Plot specified circuit object parameters using log scale for <i>x</i> -axis
smith	Plot specified circuit object parameters on Smith chart
smith	Plot specified circuit object parameters on Smith chart
write	Write RF data from circuit or data object to file
write	Write RF data from circuit or data object to file

## Examples

```
tx1=rfckt.twowire('Radius',7.5e-4)
```

```
tx1 =
```

```
Name: 'Two-Wire Transmission Line'  
nPort: 2  
AnalyzedResult: []  
LineLength: 0.0100  
StubMode: 'NotAStub'
```

Termination: 'NotApplicable'  
Radius: 7.5000e-004  
Separation: 0.0016  
MuR: 1  
EpsilonR: 2.3000  
LossTangent: 0  
SigmaCond: Inf

## References

Pozar, David M. *Microwave Engineering*, John Wiley & Sons, Inc., 2005.

## See Also

rfckt.coaxial | rfckt.cpw | rfckt.microstrip |  
rfckt.parallelplate | rfckt.rlcgline | rfckt.txline

**Purpose** General transmission line

**Syntax**  
`h = rfckt.txline`  
`h = rfckt.txline('Property1',value1,'Property2',value2,...)`

**Description** Use the txline class to represent transmission lines that are characterized by line loss, line length, stub type, and termination.

`h = rfckt.txline` returns a transmission line object whose properties are set to their default values.

`h = rfckt.txline('Property1',value1,'Property2',value2,...)` returns a transmission line object, h, with the specified properties. Properties that you do not specify retain their default values.

<b>Properties</b>	AnalyzedResult	Computed S-parameters, noise figure, OIP3, and group delay values
	Freq	Frequency data
	IntpType	Interpolation method
	LineLength	Transmission line length
	Loss	Transmission line loss
	Name	Object name
	nPort	Number of ports
	PV	Phase velocity
	StubMode	Type of stub
	Termination	Stub transmission line termination
	Z0	Characteristic impedance

## Methods

analyze	Analyze circuit object in frequency domain
analyze	Analyze circuit object in frequency domain
calculate	Calculate specified parameters for circuit object
calculate	Calculate specified parameters for circuit object
circle	Draw circles on Smith chart
circle	Draw circles on Smith chart
getz0	Characteristic impedance of transmission line object
getz0	Characteristic impedance of transmission line object
listformat	List valid formats for specified circuit object parameter
listformat	List valid formats for specified circuit object parameter
listparam	List valid parameters for specified circuit object
listparam	List valid parameters for specified circuit object
loglog	Plot specified circuit object parameters using log-log scale
loglog	Plot specified circuit object parameters using log-log scale
plot	Plot specified circuit object parameters on X-Y plane

---

plot	Plot specified circuit object parameters on X-Y plane
plotyy	Plot specified object parameters with $y$ -axes on both left and right sides
plotyy	Plot specified object parameters with $y$ -axes on both left and right sides
polar	Plot specified circuit object parameters on polar coordinates
polar	Plot specified circuit object parameters on polar coordinates
semilogx	Plot specified circuit object parameters using log scale for $x$ -axis
semilogx	Plot specified circuit object parameters using log scale for $x$ -axis
semilogy	Plot specified circuit object parameters using log scale for $x$ -axis
semilogy	Plot specified circuit object parameters using log scale for $x$ -axis
smith	Plot specified circuit object parameters on Smith chart
smith	Plot specified circuit object parameters on Smith chart

write	Write RF data from circuit or data object to file
write	Write RF data from circuit or data object to file

## Examples

Construct a general transmission line, `tr1`, with the default characteristic impedance of 50 ohms, phase velocity of 299792458 meters per second, and line length of 0.01 meters. Then perform frequency domain analysis from 1.0 GHz to 3.0 GHz. Plot the resulting  $S_{21}$  network parameters, using the 'angle' format, on the X-Y plane.

```
tr1 = rfckt.txline('Z0',75)

tr1 =

    Name: 'Transmission Line'
    nPort: 2
    AnalyzedResult: []
    LineLength: 0.0100
    StubMode: 'NotAStub'
    Termination: 'NotApplicable'
    Freq: 1.0000e+009
    Z0: 75
    PV: 299792458
    Loss: 0
    IntpType: 'Linear'

f = [1e9:1.0e7:3e9]; % Simulation frequencies
analyze(tr1,f); % Do frequency domain analysis
figure
plot(tr1,'s21','angle'); % Plot magnitude of S21
```



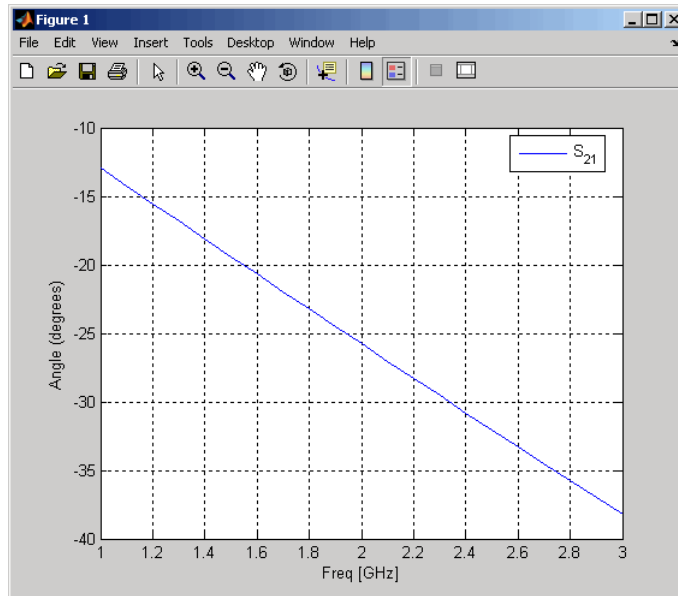

## References

Ludwig, R. and P. Bretchko, *RF Circuit Design: Theory and Applications*, Prentice-Hall, 2000.

## See Also

[rfckt.coaxial](#) | [rfckt.cpw](#) | [rfckt.microstrip](#) |  
[rfckt.parallelplate](#) | [rfckt.rlcgline](#) | [rfckt.twowire](#)

# rfdata.data

---

**Purpose** Store result of circuit object analysis

**Syntax**  
`h = rfdata.data`  
`h = rfdata.data('Property1',value1,'Property2',value2,...)`

**Description** Use the data class to store S-parameters, noise figure in decibels, and frequency-dependent, third-order output (OIP3) intercept points.

There are three ways to create an `rfdata.data` object:

- You can construct it by specifying its properties from workspace data using the `rfdata.data` constructor.
- You can create it from file data using the `read` method.
- You can perform frequency domain analysis of a circuit object using the `analyze` method, and RF Toolbox software stores the results in an `rfdata.data` object.

`h = rfdata.data` returns a data object whose properties all have their default values.

`h = rfdata.data('Property1',value1,'Property2',value2,...)` returns a data object, `h`, based on the specified properties. Properties that you do not specify retain their default values.

Use the `read` method to read data from a file.

<b>Properties</b>		
	<code>Freq</code>	Frequency data
	<code>GroupDelay</code>	Group delay data
	<code>IntpType</code>	Interpolation method
	<code>Name</code>	Object name
	<code>NF</code>	Noise figure
	<code>OIP3</code>	Output third-order intercept point

S_Parameters	S-parameter data
Z0	Reference impedance
ZL	Load impedance
ZS	Source impedance

## Methods

analyze	Analyze circuit object in frequency domain
analyze	Analyze circuit object in frequency domain
calculate	Calculate specified parameters for circuit object
calculate	Calculate specified parameters for circuit object
circle	Draw circles on Smith chart
circle	Draw circles on Smith chart
extract	Extract array of network parameters from data object
extract	Extract array of network parameters from data object
getop	Display operating conditions
getop	Display operating conditions
listformat	List valid formats for specified circuit object parameter
listformat	List valid formats for specified circuit object parameter
listparam	List valid parameters for specified circuit object

listparam	List valid parameters for specified circuit object
loglog	Plot specified circuit object parameters using log-log scale
loglog	Plot specified circuit object parameters using log-log scale
plot	Plot specified circuit object parameters on X-Y plane
plot	Plot specified circuit object parameters on X-Y plane
plotyy	Plot specified object parameters with <i>y</i> -axes on both left and right sides
plotyy	Plot specified object parameters with <i>y</i> -axes on both left and right sides
polar	Plot specified circuit object parameters on polar coordinates
polar	Plot specified circuit object parameters on polar coordinates
read	Read RF data from file to new or existing circuit or data object
read	Read RF data from file to new or existing circuit or data object
restore	Restore data to original frequencies
restore	Restore data to original frequencies

semilogx	Plot specified circuit object parameters using log scale for <i>x</i> -axis
semilogx	Plot specified circuit object parameters using log scale for <i>x</i> -axis
semilogy	Plot specified circuit object parameters using log scale for <i>x</i> -axis
semilogy	Plot specified circuit object parameters using log scale for <i>x</i> -axis
smith	Plot specified circuit object parameters on Smith chart
smith	Plot specified circuit object parameters on Smith chart
write	Write RF data from circuit or data object to file
write	Write RF data from circuit or data object to file

## Examples

Construct an RF data object from a .s2p data file.

```
file = 'default.s2p';
h = read(rfdata.data,file); % Read file into data object.
figure
plot(h,'s21','db'); % Plot dB(S21) in XY plane.
```

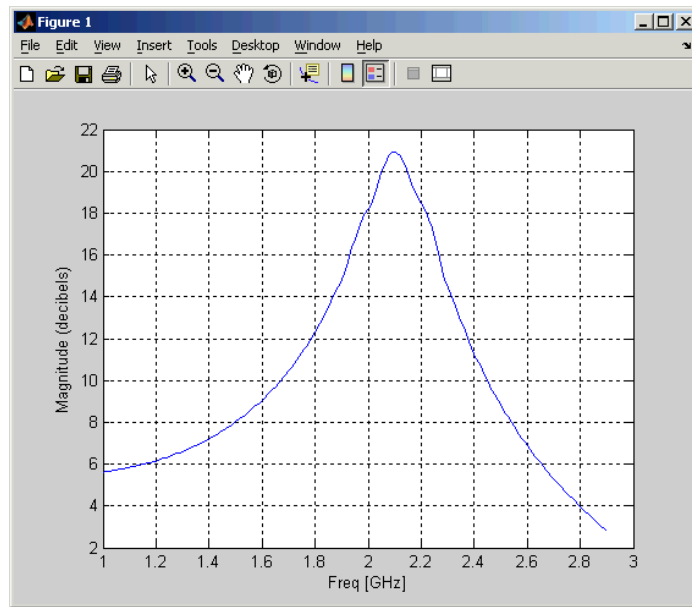

## See Also

`rfdata.ip3` | `rfdata.mixerspur` | `rfdata.network` | `rfdata.nf` |  
`rfdata.noise` | `rfdata.power`

**Purpose** Store frequency-dependent, third-order intercept points

**Syntax**

```
h = rfddata.ip3
h = rfddata.ip3('Type',value1,'Freq',value2,'Data',value3)
```

**Description** Use the ip3 class to store third-order intercept point specifications for a circuit object.

h = rfddata.ip3 returns a data object for the frequency-dependent IP3, h, whose properties all have their default values.

h = rfddata.ip3('Type',value1,'Freq',value2,'Data',value3) returns a data object for the frequency-dependent IP3, h, based on the specified properties.

**Properties**

Data	Third-order intercept values
Freq	Frequency data
Name	Object name
Type	Power reference type

**Examples**

```
ip3data = rfddata.ip3...
           ('Type','OIP3','Freq',2.1e9,'Data',8.45)

ip3data =

    Name: '3rd order intercept'
    Type: 'OIP3'
    Freq: 2.1000e+009
    Data: 8.4500
```

**See Also** [rfddata.data](#) | [rfddata.mixerspur](#) | [rfddata.network](#) | [rfddata.nf](#) | [rfddata.noise](#) | [rfddata.power](#)

# rfdata.mixerspurspur

---

**Purpose** Store data from intermodulation table

**Syntax**

```
h = rfdata.mixerspurspur
h = rfdata.mixerspurspur('Data',value1,'PLORef',value2,'PinRef',
    'value3')
```

**Description** Use the mixerspurspur class to store mixer spur power specifications for a circuit object.

h = rfdata.mixerspurspur returns a data object that defines an intermodulation table, h, whose properties all have their default values.

h =  
rfdata.mixerspurspur('Data',value1,'PLORef',value2,'PinRef','value3)  
returns a data object that defines an intermodulation table,  
h, based on the specified properties.

<b>Properties</b>	Data	Mixer spur power values
	Name	Object name
	PinRef	Reference input power
	PLORef	Reference local oscillator power

**Examples**

```
spurs = rfdata.mixerspurspur...
    ('Data',[2 5 3; 1 0 99; 10 99 99],...
    'PinRef',3,'PLORef',5)
```

```
spurs =

    Name: 'Intermodulation table'
    PLORef: 5
    PinRef: 3
    Data: [3x3 double]
```



## See Also

[rfdata.data](#) | [rfdata.ip3](#) | [rfdata.network](#) | [rfdata.nf](#) |  
[rfdata.noise](#) | [rfdata.power](#) | [Visualizing Mixer Spurs](#)

# rfdata.network

---

**Purpose** Store frequency-dependent network parameters

**Syntax**

```
h = rfdata.network
h = rfdata.network('Type',value1,'Freq',value2, 'Data',value3,
    'Z0',value4)
```

**Description** Use the network class to store frequency-dependent S-, Y-, Z-, ABCD-, H-, G-, or T-parameters for a circuit object.

`h = rfdata.network` returns a data object for the frequency-dependent network parameters `h`, whose properties all have their default values.

`h = rfdata.network('Type',value1,'Freq',value2, 'Data',value3, 'Z0',value4)` returns a data object for the frequency-dependent network parameters, `h`, based on the specified properties.

<b>Properties</b>	Data	Network parameter data
	Freq	Frequency data
	Name	Object name
	Type	Type of network parameters.
	Z0	Reference impedance

**Examples**

```
f = [2.08 2.10 2.15]*1.0e9;
y(:,:,1) = [-.0090-.0104i, .0013+.0018i; ...
    -.2947+.2961i, .0252+.0075i];
y(:,:,2) = [-.0086-.0047i, .0014+.0019i; ...
    -.3047+.3083i, .0251+.0086i];
y(:,:,3) = [-.0051+.0130i, .0017+.0020i; ...
    -.3335+.3861i, .0282+.0110i];

net = rfdata.network...
    ('Type','Y_PARAMETERS','Freq',f,'Data',y)
```

**See Also**

`rfdata.data` | `rfdata.ip3` | `rfdata.mixerspur` | `rfdata.nf` |  
`rfdata.noise` | `rfdata.power`

# rfdata.nf

---

**Purpose** Store frequency-dependent noise figure data for amplifiers or mixers

**Syntax**  
`h = rfdata.nf`  
`h = rfdata.nf('Freq',value1,'Data',value2)`

**Description** Use the `nf` class to store noise figure specifications for a circuit object.  
`h = rfdata.nf` returns a data object for the frequency-dependent noise figure, `h`, whose properties all have their default values.  
`h = rfdata.nf('Freq',value1,'Data',value2)` returns a data object for the frequency-dependent noise figure, `h`, based on the specified properties.

<b>Properties</b>	Data	Noise figure values
	Freq	Frequency data
	Name	Object name

**Examples**  
`f = 2.0e9;`  
`nf = 13.3244;`  
  
`nfdata = rfdata.nf('Freq',f,'Data',nf);`

**See Also** `rfdata.data` | `rfdata.ip3` | `rfdata.mixerspur` | `rfdata.network`  
| `rfdata.noise` | `rfdata.power`

**Purpose** Store frequency-dependent spot noise data for amplifiers or mixers

**Syntax**

```
h = rfdata.noise
h = rfdata.noise('Freq',value1,'FMIN',value2,'GAMMAOPT',
                 value3,'RN',value4)
```

**Description** Use the noise class to store spot noise specifications for a circuit object.

`h = rfdata.noise` returns a data object for the frequency-dependent spot noise, `h`, whose properties all have their default values.

`h = rfdata.noise('Freq',value1,'FMIN',value2,'GAMMAOPT',value3,'RN',value4)` returns a data object for the frequency-dependent spot noise, `h`, based on the specified properties.

<b>Properties</b>	FMIN	Minimum noise figure data
	Freq	Frequency data
	GAMMAOPT	Optimum source reflection coefficients
	Name	Object name
	RN	Equivalent normalized noise resistance data

**Examples**

```
f = [2.08 2.10]*1.0e9;
fmin = [12.08 13.40];
gopt = [0.2484-1.2102j 1.0999-0.9295j];
rn = [0.26 0.45];

noisedata = rfdata.noise('Freq',f,'FMIN',fmin,...
                        'GAMMAOPT',gopt,'RN',rn);
```

**See Also** `rfdata.data` | `rfdata.mixerspur` | `rfdata.network` | `rfdata.nf` | `rfdata.power`

# rfdata.power

---

**Purpose** Store output power and phase information for amplifiers or mixers

**Syntax** `h = rfdata.power`  
`h = rfdata.power(`property1`,value1,'property2',value2,...)`

**Description** Use the power class to store output power and phase specifications for a circuit object.

`h = rfdata.power` returns a data object for the Pin/Pout power data, `h`, whose properties all have their default values.

`h = rfdata.power(`property1`,value1,'property2',value2,...)` returns a data object for the Pin/Pout power data, `h`, based on the specified properties.

<b>Properties</b>	Freq	Frequency data
	Name	Object name
	Phase	Phase shift data
	Pin	Input power data
	Pout	Output power data

**Examples**

```
f = [2.08 2.10]*1.0e9;
phase = {[27.1 35.3],[15.4 19.3 21.1]};
pin = {[0.001 0.002],[0.001 0.005 0.01]};
pout = {[0.0025 0.0031],[0.0025 0.0028 0.0028]};
powerdata = rfdata.power;
powerdata.Freq = f;
powerdata.Phase = phase;
powerdata.Pin = pin;
powerdata.Pout = pout;
```

**See Also** `rfdata.data` | `rfdata.ip3` | `rfdata.mixerspur` | `rfdata.network` | `rfdata.nf` | `rfdata.noise`

**Purpose** Rational function model

**Syntax**

```
h = rfmodel.rational
h = rfmodel.rational('Property1',value1,'Property2',value2,
    ...)
```

**Description** Use the rational class to represent RF components using a rational function model of the form

$$F(s) = \left( \sum_{k=1}^n \frac{C_k}{s - A_k} + D \right) e^{-s\tau}, \quad s = j2\pi f$$

There are two ways to construct an `rfmodel.rational` object:

- You can fit a rational function model to the component data using the `rationalfit` function.
- You can use the `rfmodel.rational` constructor to specify the pole-residue representation of the component directly.

`h = rfmodel.rational` returns a rational function model object whose properties are set to their default values.

`h = rfmodel.rational('Property1',value1,'Property2',value2,...)` returns a rational function model object, `h`, with the specified properties. Properties that you do not specify retain their default values.

## Properties

A	Poles of rational function
C	Residues of rational function
D	Frequency response offset
Delay	Frequency response time delay
Name	Object name

## Methods

freqresp	Frequency response of model object
freqresp	requency response of model object
ispassive	Check passivity of model object
ispassive	Check passivity of scalar model object
stepresp	response of model object
stepresp	Step-signal response of model object
timeresp	ime response for model object
timeresp	Time response for model object
writeva	Write Verilog-A description of RF model object
writeva	Write Verilog-A description of RF model object

## Examples

Fit a rational function to data from an `rfdata.data` object:

```
orig_data=read(rfdata.data,'default.s2p');
freq=orig_data.Freq;
data=orig_data.S_Parameters(2,1,:);
fit_data=rationalfit(freq,data)
```

```
fit_data =
```

```
    Name: 'Rational Function'  
    A: [2x1 double]  
    C: [2x1 double]  
    D: 0  
    Delay: 0
```

---



Define, evaluate, and visualize a rational function in three steps:

- Construct a rational function model, `rat`, with poles at  $-4$  Mrad/s,  $-3$  Grad/s, and  $-5$  Grad/s and residues of  $600$  Mrad/s,  $2$  Grad/s and  $4$  Grad/s.
- Perform frequency-domain analysis from  $1.0$  MHz to  $3.0$  GHz.
- Plot the resulting frequency response in decibels on the X-Y plane.

```
rat=rfmodel.rational...
    ('A',[-5e9,-3e9,-4e6],...
     'C',[6e8,2e9,4e9]);    % Create model
f = [1e6:1.0e7:3e9];
[resp,freq]=freqresp(rat,f); % Compute frequency response
figure
plot(freq/1e9,db(resp));    % Plot frequency response
xlabel('Frequency (GHz)')
ylabel('Magnitude (dB)')
```

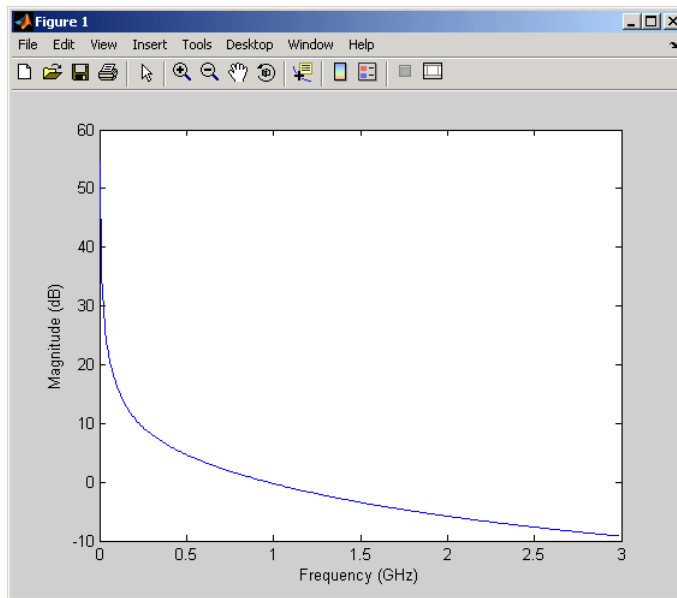

# rfckt.amplifier.AnalyzedResult property

---

<b>Purpose</b>	Computed S-parameters, noise figure, OIP3, and group delay values
<b>Values</b>	rfdata.data object
<b>Description</b>	Handle to an rfdata.data object that contains the S-parameters, noise figure, OIP3, and group delay values computed over the specified frequency range using the analyze method. The default is a 1-by-1 rfdata.data object that contains the S-parameters, noise figure, OIP3, and group delay values that result from analyzing the values stored in the default.amp file at the frequencies stored in this file.

The analyze method computes the AnalyzedResult property using the data stored in the rfckt.amplifier object properties as follows:

- The analyze method uses the data stored in the 'NoiseData' property of the rfckt.amplifier object to calculate the noise figure.
- The analyze method uses the data stored in the 'NonlinearData' property of the rfckt.amplifier object to calculate OIP3.

If power data exists in the 'NonlinearData' property, the block extracts the AM/AM and AM/PM nonlinearities from the power data.

If the 'NonlinearData' property contains only IP3 data, the method computes and adds the nonlinearity by:

- 1 Using the third-order input intercept point value in dBm to compute the factor,  $f$ , that scales the input signal before the amplifier object applies the nonlinearity:

$$F_{AM/AM}(u) = u - \frac{u^3}{3}$$

- 2 Computing the scaled input signal by multiplying the amplifier input signal by  $f$ .
- 3 Limiting the scaled input signal to a maximum value of 1.
- 4 Applying an AM/AM conversion to the amplifier gain, according to the following cubic polynomial equation:

# rfckt.amplifier.AnalyzedResult property

$$F_{AM/AM}(u) = u - \frac{u^3}{3}$$

where  $u$  is the magnitude of the scaled input signal, which is a unitless normalized input voltage.

- The analyze method uses the data stored in the 'NetworkData' property of the rfckt.amplifier object to calculate the group delay values of the amplifier at the frequencies specified in freq, as described in the analyze reference page.
- The analyze method uses the data stored in the 'NetworkData' property of the rfckt.amplifier object to calculate the S-parameter values of the amplifier at the frequencies specified in freq. If the 'NetworkData' property contains network Y- or Z-parameters, the analyze method first converts the parameters to S-parameters. Using the interpolation method you specify with the 'IntpType' property, the analyze method interpolates the S-parameter values to determine their values at the specified frequencies.

Specifically, the analyze method orders the S-parameters according to the ascending order of their frequencies,  $f_n$ . It then interpolates the S-parameters, using the MATLAB interp1 function. For example, the curve in the following diagram illustrates the result of interpolating the  $S_{11}$  parameters at five different frequencies.

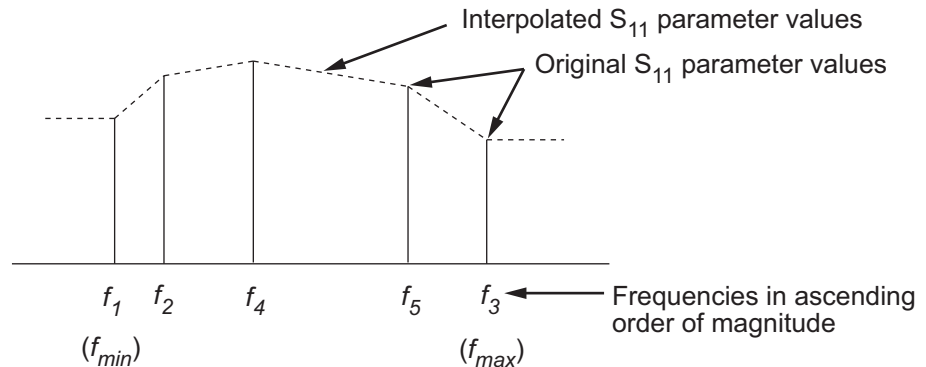

# rfckt.amplifier.AnalyzedResult property

---

For more information, see “One-Dimensional Interpolation” and the `interp1` reference page in the MATLAB documentation.

As shown in the preceding diagram, the `analyze` method uses the parameter values at  $f_{min}$ , the minimum input frequency, for all frequencies smaller than  $f_{min}$ . It uses the parameters values at  $f_{max}$ , the maximum input frequency, for all frequencies greater than  $f_{max}$ . In both cases, the results may not be accurate, so you need to specify network parameter values over a range of frequencies that is wide enough to account for the amplifier behavior.

## Examples

```
amp = rfckt.amplifier;  
amp.AnalyzedResult  
  
ans =  
  
    Name: 'Data object'  
    Freq: [191x1 double]  
    S_Parameters: [2x2x191 double]  
    GroupDelay: [191x1 double]  
    NF: [191x1 double]  
    OIP3: [191x1 double]  
    ZO: 50  
    ZS: 50  
    ZL: 50  
    IntpType: 'Linear'
```

# rfckt.amplifier.IntpType property

---

**Purpose** Interpolation method

**Values** 'Linear' (default), 'Spline', or 'Cubic'

**Description** The analyze method is flexible in that it does not require the frequencies of the specified S-parameters to match the requested analysis frequencies. If needed, analyze applies the interpolation and extrapolation method specified in the IntpType property to the specified data to create a new set of data at the requested analysis frequencies. The following table lists the available interpolation methods and describes each one.

Method	Description
Linear (default)	Linear interpolation
Spline	Cubic spline interpolation
Cubic	Piecewise cubic Hermite interpolation

## Examples

```
amp = rfckt.amplifier;  
amp.IntpType = 'cubic'
```

```
amp =
```

```
Name: 'Amplifier'  
nPort: 2  
AnalyzedResult: [1x1 rfddata.data]  
IntpType: 'Cubic'  
NetworkData: [1x1 rfddata.network]  
NoiseData: [1x1 rfddata.noise]  
NonlinearData: [1x1 rfddata.power]
```

## rfckt.amplifier.Name property

---

<b>Purpose</b>	Object name
<b>Values</b>	'Amplifier'
<b>Description</b>	Read-only string that contains the name of the object.
<b>Examples</b>	<pre>amp = rfckt.amplifier; amp.Name  ans =      Amplifier</pre>

# rfckt.amplifier.NetworkData property

---

**Purpose** Network parameter information

**Values** rfdata.network object

**Description** An rfdata.network object that stores network parameter data. The default network parameter values are taken from the 'default.amp' data file.

**Examples**

```
amp = rfckt.amplifier;
amp.NetworkData

ans =

    Name: 'Network parameters'
    Type: 'S_PARAMETERS'
    Freq: [191x1 double]
    Data: [2x2x191 double]
    Z0: 50
```



# rfckt.amplifier.NoiseData property

---

<b>Purpose</b>	Noise information
<b>Values</b>	Scalar noise figure in decibels, <code>rfdata.noise</code> object or <code>rfdata.nf</code> object
<b>Description</b>	A scalar value or object that stores noise data. The default is an <code>rfdata.noise</code> object whose values are taken from the 'default.amp' data file.
<b>Examples</b>	<pre>amp = rfckt.amplifier; amp.NoiseData  ans =        Name: 'Spot noise data'       Freq: [9x1 double]       FMIN: [9x1 double]       GAMMAOPT: [9x1 double]       RN: [9x1 double]</pre>

# rfckt.amplifier.NonlinearData property

---

<b>Purpose</b>	Nonlinearity information
<b>Values</b>	Scalar OIP3 in decibels relative to one milliwatt, <code>rfdata.power</code> object or <code>rfdata.ip3</code> object
<b>Description</b>	A scalar value or object that stores nonlinearity data. The default is an <code>rfdata.power</code> object whose values are taken from the 'default.amp' data file.
<b>Examples</b>	<pre>amp = rfckt.amplifier; amp.NonlinearData  ans =      Name: 'Power data'     Freq: 2.1000e+009     Pin: {[20x1 double]}     Pout: {[20x1 double]}     Phase: {[20x1 double]}</pre>

**Purpose** Number of ports

**Values** 2

**Description** A read-only integer that indicates the object has two ports.

**Examples**

```
amp = rfckt.amplifier;  
amp.nPort  
  
ans =  
  
    2
```

# rfckt.cascade.AnalyzedResult property

---

**Purpose** Computed S-parameters, noise figure, OIP3, and group delay values

**Values** `rfdata.data` object

**Description** Handle to an `rfdata.data` object that contains the S-parameters, noise figure, OIP3, and group delay values computed over the specified frequency range using the `analyze` method. This property is empty by default.

The `analyze` method computes the `AnalyzedResult` property using the data stored in the `Ckts` property as follows:

- The `analyze` method starts calculating the ABCD-parameters of the cascaded network by converting each component network's parameters to an ABCD-parameters matrix. The figure shows a cascaded network consisting of two 2-port networks, each represented by its ABCD matrix.

The `analyze` method then calculates the ABCD-parameter matrix for the cascaded network by calculating the product of the ABCD matrices of the individual networks.

The following figure shows a cascaded network consisting of two 2-port networks, each represented by its ABCD-parameters.

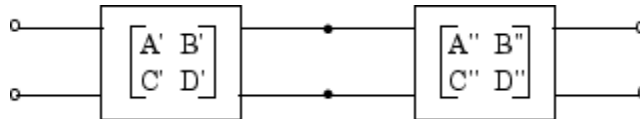

The following equation illustrates calculations of the ABCD-parameters for two 2-port networks.

$$\begin{bmatrix} A & B \\ C & D \end{bmatrix} = \begin{bmatrix} A' & B' \\ C' & D' \end{bmatrix} \begin{bmatrix} A'' & B'' \\ C'' & D'' \end{bmatrix}$$

Finally, `analyze` converts the ABCD-parameters of the cascaded network to S-parameters at the frequencies specified in the `analyze` input argument `freq`.

- The analyze method calculates the noise figure for an N-element cascade. First, the method calculates noise correlation matrices  $C_A'$  and  $C_A''$ , corresponding to the first two matrices in the cascade, using the following equation:

$$C_A = 2kT \begin{bmatrix} R_n & \frac{NF_{\min} - 1}{2} - R_n Y_{opt}^* \\ \frac{NF_{\min} - 1}{2} - R_n Y_{opt} & R_n |Y_{opt}|^2 \end{bmatrix}$$

where  $k$  is Boltzmann's constant, and  $T$  is the noise temperature in Kelvin.

The method combines  $C_A'$  and  $C_A''$  into a single correlation matrix  $C_A$  using the equation

$$C_A = C_A' + \begin{bmatrix} A' & B' \\ C' & D' \end{bmatrix} C_A'' \begin{bmatrix} A' & B' \\ C' & D' \end{bmatrix}$$

By applying this equation recursively, the method obtains a noise correlation matrix for the entire cascade. The method then calculates the noise factor,  $F$ , from the noise correlation matrix of as follows:

$$F = 1 + \frac{z^+ C_A z}{2kT \operatorname{Re}\{Z_S\}}$$

$$z = \begin{bmatrix} 1 \\ Z_S^* \end{bmatrix}$$

In the two preceding equations,  $Z_S$  is the nominal impedance, which is 50 ohms, and  $z^+$  is the Hermitian conjugation of  $z$ .

- The analyze method calculates the output power at the third-order intercept point (OIP3) for an N-element cascade using the following equation:

# rfckt.cascade.AnalyzedResult property

---

$$OIP_3 = \frac{1}{\frac{1}{OIP_{3,N}} + \frac{1}{G_N \cdot OIP_{3,N-1}} + \dots + \frac{1}{G_N \cdot G_{N-1} \cdot \dots \cdot G_2 \cdot OIP_{3,1}}}$$

where  $G_n$  is the gain of the  $n$ th element of the cascade and  $OIP_{3,N}$  is the  $OIP_3$  of the  $n^{\text{th}}$  element.

- The analyze method uses the cascaded S-parameters to calculate the group delay values at the frequencies specified in the analyze input argument freq, as described in the analyze reference page.

## Examples

Analyze a cascade of three circuit objects:

```
amp = rfckt.amplifier('IntpType','cubic');
tx1 = rfckt.txline;
tx2 = rfckt.txline;
casc = rfckt.cascade('Ckts',{tx1,amp,tx2});
analyze(casc,[1e9:1e7:2e9]);
casc.AnalyzedResult
```

## References

Hillbrand, H. and P.H. Russer, "An Efficient Method for Computer Aided Noise Analysis of Linear Amplifier Networks," *IEEE Transactions on Circuits and Systems*, Vol. CAS-23, Number 4, pp. 235–238, 1976.

<b>Purpose</b>	Circuit objects in network
<b>Values</b>	Cell
<b>Description</b>	Cell array containing handles to all circuit objects in the network, in order from source to load. All circuits must be 2-port. This property is empty by default.

### Examples

```
amp = rfckt.amplifier('IntpType','cubic');
tx1 = rfckt.txline;
tx2 = rfckt.txline;
casc = rfckt.cascade;
casc.Ckts = {tx1,amp,tx2};
casc.Ckts

ans =

[1x1 rfckt.txline] [1x1 rfckt.amplifier] [1x1 rfckt.txline]
```

# rfckt.cascade.Name property

---

**Purpose** Object name

**Values** 'Cascaded Network'

**Description** Read-only string that contains the name of the object.

**Examples**

```
casc = rfckt.cascade;  
casc.Name
```

```
ans =
```

```
    Cascaded Network
```



**Purpose** Number of ports

**Values** 2

**Description** A read-only integer that indicates the object has two ports.

**Examples**

```
casc = rfckt.cascade;  
casc.nPort
```

```
ans =
```

```
2
```

# rfckt.coaxial.AnalyzedResult property

---

**Purpose** Computed S-parameters, noise figure, OIP3, and group delay values

**Values** `rfdata.data` object

**Description** Handle to an `rfdata.data` object that contains the S-parameters, noise figure, OIP3, and group delay values computed over the specified frequency range using the `analyze` method. This property is empty by default.

The `analyze` method treats the transmission line as a 2-port linear network. It computes the `AnalyzedResult` property of a stub or as a stubless line using the data stored in the `rfckt.coaxial` object properties as follows:

- If you model the transmission line as a stubless line, the `analyze` method first calculates the ABCD-parameters at each frequency contained in the modeling frequencies vector. It then uses the `abcd2s` function to convert the ABCD-parameters to S-parameters.

The `analyze` method calculates the ABCD-parameters using the physical length of the transmission line,  $d$ , and the complex propagation constant,  $k$ , using the following equations:

$$A = \frac{e^{kd} + e^{-kd}}{2}$$
$$B = \frac{Z_0 * (e^{kd} - e^{-kd})}{2}$$
$$C = \frac{e^{kd} - e^{-kd}}{2 * Z_0}$$
$$D = \frac{e^{kd} + e^{-kd}}{2}$$

$Z_0$  and  $k$  are vectors whose elements correspond to the elements of  $f$ , the vector of frequencies specified in the `analyze` input argument `freq`. Both can be expressed in terms of the resistance ( $R$ ), inductance

( $L$ ), conductance ( $G$ ), and capacitance ( $C$ ) per unit length (meters) as follows:

$$Z_0 = \sqrt{\frac{R + j2\pi fL}{G + j2\pi fC}}$$
$$k = k_r + jk_i = \sqrt{(R + j2\pi fL)(G + j2\pi fC)}$$

where

$$R = \frac{1}{2\pi\sigma_{cond}\delta_{cond}} \left( \frac{1}{a} + \frac{1}{b} \right)$$
$$L = \frac{\mu}{2\pi} \ln\left(\frac{b}{a}\right)$$
$$G = \frac{2\pi\omega\epsilon''}{\ln\left(\frac{b}{a}\right)}$$
$$C = \frac{2\pi\epsilon}{\ln\left(\frac{b}{a}\right)}$$

In these equations:

- $a$  is the radius of the inner conductor.
- $b$  is the radius of the outer conductor.
- $\sigma_{cond}$  is the conductivity in the conductor.
- $\mu$  is the permeability of the dielectric.
- $\epsilon$  is the permittivity of the dielectric.
- $\epsilon''$  is the imaginary part of  $\epsilon$ ,  $\epsilon'' = \epsilon_0\epsilon_r\tan\delta$ , where:
  - $\epsilon_0$  is the permittivity of free space.
  - $\epsilon_r$  is the EpsilonR property value.
  - $\tan\delta$  is the LossTangent property value.

# rfckt.coaxial.AnalyzedResult property

- $\delta_{cond}$  is the skin depth of the conductor, which the method calculates as  $1 / \sqrt{\pi f \mu \sigma_{cond}}$ .
- $f$  is a vector of modeling frequencies determined by the Output Port block.
- If you model the transmission line as a shunt or series stub, the analyze method first calculates the ABCD-parameters at the specified frequencies. It then uses the abcd2s function to convert the ABCD-parameters to S-parameters.

When you set the StubMode property to 'Shunt', the 2-port network consists of a stub transmission line that you can terminate with either a short circuit or an open circuit as shown in the following figure.

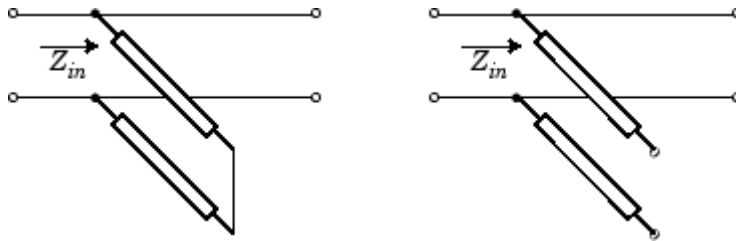

$Z_{in}$  is the input impedance of the shunt circuit. The ABCD-parameters for the shunt stub are calculated as:

$$A = 1$$

$$B = 0$$

$$C = 1 / Z_{in}$$

$$D = 1$$

When you set the StubMode property to 'Series', the 2-port network consists of a series transmission line that you can terminate with either a short circuit or an open circuit as shown in the following figure.

# rfckt.coaxial.AnalyzedResult property

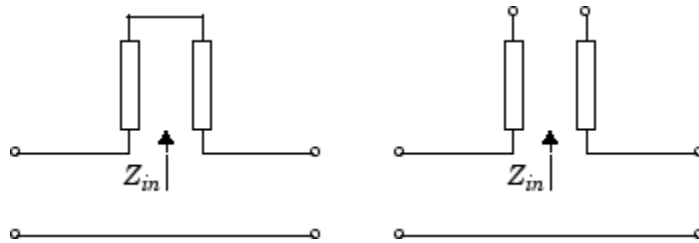

$Z_{in}$  is the input impedance of the series circuit. The ABCD-parameters for the series stub are calculated as

$$\begin{aligned} A &= 1 \\ B &= Z_{in} \\ C &= 0 \\ D &= 1 \end{aligned}$$

The analyze method uses the S-parameters to calculate the group delay values at the frequencies specified in the analyze input argument freq, as described in the analyze reference page.

## Examples

```
tx1 = rfckt.coaxial;  
analyze(tx1,[1e9,2e9,3e9]);  
tx1.AnalyzedResult
```

```
ans =
```

```
Name: 'Data object'  
Freq: [3x1 double]  
S_Parameters: [2x2x3 double]  
GroupDelay: [3x1 double]  
NF: [3x1 double]  
OIP3: [3x1 double]  
Z0: 50  
ZS: 50  
ZL: 50  
IntpType: 'Linear'
```

## rfckt.coaxial.EpsilonR property

---

**Purpose** Relative permittivity of dielectric

**Values** Scalar

**Description** The ratio of the permittivity of the dielectric,  $\epsilon$ , to the permittivity of free space,  $\epsilon_0$ . The default value is 2.3.

**Examples** Change the relative permittivity of the dielectric:

```
tx1=rfckt.coaxial;  
tx1.EpsilonR=2.7;
```

# rfckt.coaxial.InnerRadius property

---

<b>Purpose</b>	Inner conductor radius
<b>Values</b>	Scalar
<b>Description</b>	The radius of the inner conductor, in meters. The default is $7.25e-4$ .
<b>Examples</b>	<pre>tx1=rfckt.coaxial; tx1.InnerRadius=2.5e-4;</pre>

## rfckt.coaxial.LineLength property

---

**Purpose**            Transmission line length

**Values**            Scalar

**Description**        The physical length of the transmission line in meters. The default is 0.01.

**Examples**            `tx1 = rfckt.coaxial;`  
                          `tx1.LineLength = 0.001;`



# rfckt.coaxial.LossTangent property

---

<b>Purpose</b>	Tangent of loss angle
<b>Values</b>	Scalar
<b>Description</b>	The loss angle tangent of the dielectric. The default is 0.
<b>Examples</b>	<pre>tx1=rfckt.coaxial; tx1.LossTangent=0.002;</pre>

# rfckt.coaxial.MuR property

---

**Purpose** Relative permeability of dielectric

**Values** Scalar

**Description** The ratio of the permeability of the dielectric,  $\mu$ , to the permeability in free space,  $\mu_0$ . The default value is 1.

**Examples** Change the relative permeability of the dielectric:

```
tx1=rfckt.coaxial;  
tx1.MuR=0.8;
```

<b>Purpose</b>	Object name
<b>Values</b>	'Coaxial Transmission Line'
<b>Description</b>	Read-only string that contains the name of the object.
<b>Examples</b>	<pre>tx1 = rfckt.coaxial; tx1.Name  ans =      Coaxial Transmission Line</pre>

## rfckt.coaxial.OuterRadius property

---

<b>Purpose</b>	Outer conductor radius
<b>Values</b>	Scalar
<b>Description</b>	The radius of the outer conductor, in meters. The default is 0.0026.
<b>Examples</b>	<pre>tx1=rfckt.coaxial; tx1.OuterRadius=0.0031;</pre>

## rfckt.coaxial.SigmaCond property

---

<b>Purpose</b>	Conductor conductivity
<b>Values</b>	Scalar
<b>Description</b>	Conductivity, in Siemens per meter (S/m), of the conductor. The default is Inf.
<b>Examples</b>	<pre>tx1=rfckt.coaxial; tx1.SigmaCond=5.81e7;</pre>

## rfckt.coaxial.StubMode property

---

<b>Purpose</b>	Type of stub
<b>Values</b>	'NotAStub' (default), 'Series', or 'Shunt'
<b>Description</b>	String that specifies what type of stub, if any, to include in the transmission line model.
<b>Examples</b>	<pre>tx1 = rfckt.coaxial; tx1.StubMode = 'Series';</pre>

# rfckt.coaxial.Termination property

---

<b>Purpose</b>	Stub transmission line termination
<b>Values</b>	'NotApplicable' (default), 'Open', or 'Short'.
<b>Description</b>	String that specifies what type of termination to use for 'Shunt' and 'Series' stub modes. Termination is ignored if the line has no stub. Use 'NotApplicable' when StubMode is 'NotAStub'.
<b>Examples</b>	<pre>tx1 = rfckt.coaxial; tx1.StubMode = 'Series'; tx1.Termination = 'Short';</pre>

## rfckt.coaxial.nPort property

---

<b>Purpose</b>	Number of ports
<b>Values</b>	2
<b>Description</b>	A read-only integer that indicates the object has two ports.
<b>Examples</b>	<pre>tx1 = rfckt.coaxial; tx1.nPort  ans =  2</pre>



**Purpose** Computed S-parameters, noise figure, OIP3, and group delay values

**Values** rfdata.data object

**Description** Handle to an rfdata.data object that contains the S-parameters, noise figure, OIP3, and group delay values computed over the specified frequency range using the analyze method. This property is empty by default.

The analyze method treats the transmission line as a 2-port linear network. It computes the AnalyzedResult property of a stub or as a stubless line using the data stored in the rfckt.cpw object properties as follows:

- If you model the transmission line as a stubless line, the analyze method first calculates the ABCD-parameters at each frequency contained in the modeling frequencies vector. It then uses the abcd2s function to convert the ABCD-parameters to S-parameters.

The analyze method calculates the ABCD-parameters using the physical length of the transmission line,  $d$ , and the complex propagation constant,  $k$ , using the following equations:

$$A = \frac{e^{kd} + e^{-kd}}{2}$$
$$B = \frac{Z_0 * (e^{kd} - e^{-kd})}{2}$$
$$C = \frac{e^{kd} - e^{-kd}}{2 * Z_0}$$
$$D = \frac{e^{kd} + e^{-kd}}{2}$$

$Z_0$  and  $k$  are vectors whose elements correspond to the elements of  $f$ , the vector of frequencies specified in the analyze input argument freq. Both can be expressed in terms of the specified conductor

## rfckt.cpw.AnalyzedResult property

---

strip width, slot width, substrate height, conductor strip thickness, relative permittivity constant, conductivity and dielectric loss tangent of the transmission line, as described in [1].

- If you model the transmission line as a shunt or series stub, the analyze method first calculates the ABCD-parameters at the specified frequencies. It then uses the `abcd2s` function to convert the ABCD-parameters to S-parameters.

When you set the `StubMode` property to 'Shunt', the 2-port network consists of a stub transmission line that you can terminate with either a short circuit or an open circuit as shown in the following figure.

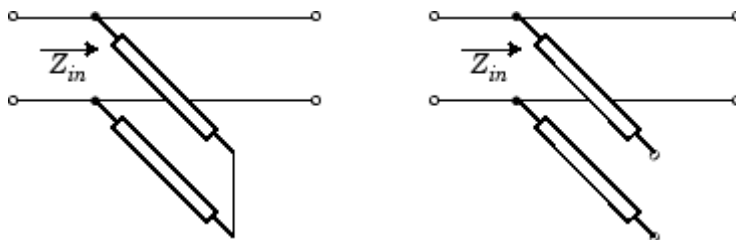

$Z_{in}$  is the input impedance of the shunt circuit. The ABCD-parameters for the shunt stub are calculated as:

$$A = 1$$

$$B = 0$$

$$C = 1 / Z_{in}$$

$$D = 1$$

When you set the `StubMode` property to 'Series', the 2-port network consists of a series transmission line that you can terminate with either a short circuit or an open circuit as shown in the following figure.

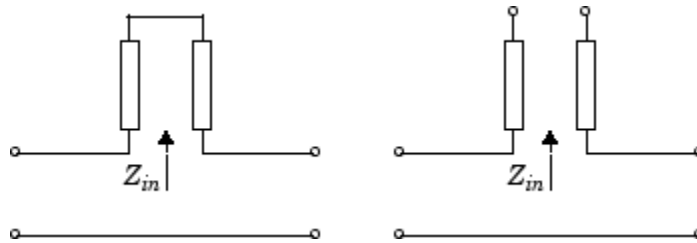

$Z_{in}$  is the input impedance of the series circuit. The ABCD-parameters for the series stub are calculated as:

$$\begin{aligned} A &= 1 \\ B &= Z_{in} \\ C &= 0 \\ D &= 1 \end{aligned}$$

The analyze method uses the S-parameters to calculate the group delay values at the frequencies specified in the analyze input argument freq, as described in the analyze reference page.

## Examples

```
tx1 = rfckt.cpw;  
analyze(tx1,[1e9,2e9,3e9]);  
tx1.AnalyzedResult
```

```
ans =
```

```
Name: 'Data object'  
Freq: [3x1 double]  
S_Parameters: [2x2x3 double]  
NF: [3x1 double]  
GroupDelay: [3x1 double]  
OIP3: [3x1 double]  
Z0: 50  
ZS: 50  
ZL: 50  
IntpType: 'Linear'
```

## rfckt.cpw.ConductorWidth property

---

<b>Purpose</b>	Conductor width
<b>Values</b>	Scalar
<b>Description</b>	Physical width, in meters, of the conductor. The default is $0.6e-4$ .
<b>Examples</b>	<pre>tx1=rfckt.cpw; tx1.ConductorWidth=0.001;</pre>

<b>Purpose</b>	Relative permittivity of dielectric
<b>Values</b>	Scalar
<b>Description</b>	The ratio of the permittivity of the dielectric, $\epsilon$ , to the permittivity of free space, $\epsilon_0$ . The default value is 9.8.
<b>Examples</b>	Change the relative permittivity of the dielectric:  <pre>tx1=rfckt.cpw; tx1.EpsilonR=2.7;</pre>

# rfckt.cpw.Height property

---

**Purpose** Dielectric thickness

**Values** Scalar

**Description** Physical height, in meters, of the dielectric on which the conductor resides. The default is  $0.635e-4$ .

**Examples**

```
tx1=rfckt.cpw;  
tx1.Height=0.001;
```

**Purpose** Transmission line length

**Values** Scalar

**Description** The physical length of the transmission line in meters. The default is 0.01.

**Examples**

```
tx1 = rfckt.cpw;  
tx1.LineLength = 0.001;
```

# rfckt.cpw.LossTangent property

---

**Purpose** Tangent of loss angle

**Values** Scalar

**Description** The loss angle tangent of the dielectric. The default is 0.

**Examples** `tx1 = rfckt.cpw;`  
`tx1.LossTangent`

```
ans =
```

```
0
```



**Purpose** Object name

**Values** 'Coplanar Waveguide Transmission Line'

**Description** Read-only string that contains the name of the object.

**Examples**

```
tx1 = rfckt.cpw;  
tx1.Name
```

```
ans =
```

```
Coplanar Waveguide Transmission Line
```

## rfckt.cpw.SigmaCond property

---

**Purpose** Conductor conductivity

**Values** Scalar

**Description** Conductivity, in Siemens per meter (S/m), of the conductor. The default is Inf.

**Examples**

```
tx1=rfckt.cpw;  
tx1.SigmaCond=5.81e7;
```

<b>Purpose</b>	Width of slot
<b>Values</b>	Scalar
<b>Description</b>	Physical width, in meters, of the slot. The default is $0.2e-4$ .
<b>Examples</b>	<pre>tx1=rfckt.cpw; tx1.SlotWidth=0.002;</pre>

## rfckt.cpw.StubMode property

---

<b>Purpose</b>	Type of stub
<b>Values</b>	'NotAStub' (default), 'Series', or 'Shunt'
<b>Description</b>	String that specifies what type of stub, if any, to include in the transmission line model.
<b>Examples</b>	<pre>tx1 = rfckt.cpw; tx1.StubMode = 'Series';</pre>

<b>Purpose</b>	Stub transmission line termination
<b>Values</b>	'NotApplicable' (default), 'Open', or 'Short'.
<b>Description</b>	String that specifies what type of termination to use for 'Shunt' and 'Series' stub modes. Termination is ignored if the line has no stub. Use 'NotApplicable' when StubMode is 'NotAStub'.
<b>Examples</b>	<pre>tx1 = rfckt.cpw; tx1.StubMode = 'Series'; tx1.Termination = 'Short';</pre>

# rfckt.cpw.Thickness property

---

**Purpose** Conductor thickness

**Values** Scalar

**Description** Physical thickness, in meters, of the conductor. The default is  $0.005e-6$ .

**Examples**

```
tx1=rfckt.cpw;  
tx1.Thickness=2e-5;
```

<b>Purpose</b>	Number of ports
<b>Values</b>	2
<b>Description</b>	A read-only integer that indicates the object has two ports.
<b>Examples</b>	<pre>tx1 = rfckt.cpw; tx1.nPort  ans =        2</pre>

# rfckt.datafile.AnalyzedResult property

**Purpose** Computed S-parameters, noise figure, OIP3, and group delay values

**Values** `rfdata.data` object

**Description** Handle to an `rfdata.data` object that contains the S-parameters, noise figure, OIP3, and group delay values computed over the specified frequency range using the `analyze` method. The default is a 1-by-1 `rfdata.data` object that contains the S-parameters, noise figure, OIP3, and group delay values that are the result of analyzing the values stored in the `passive.s2p` file at the frequencies stored in this file.

The `analyze` method computes the `AnalyzedResult` property using the data stored in the `File` object property. If the file you specify with this property contains network Y- or Z-parameters, `analyze` first converts these parameters, as they exist in the `rfckt.datafile` object, to S-parameters. Using the interpolation method you specify with the `'IntpType'` property, `analyze` interpolates the S-parameters to determine the S-parameters at the specified frequencies. Specifically, `analyze` orders the S-parameters according to the ascending order of their frequencies,  $f_n$ . It then interpolates the S-parameters, using the MATLAB `interp1` function. For example, the curve in the following diagram illustrates the result of interpolating the  $S_{11}$  parameters at five different frequencies.

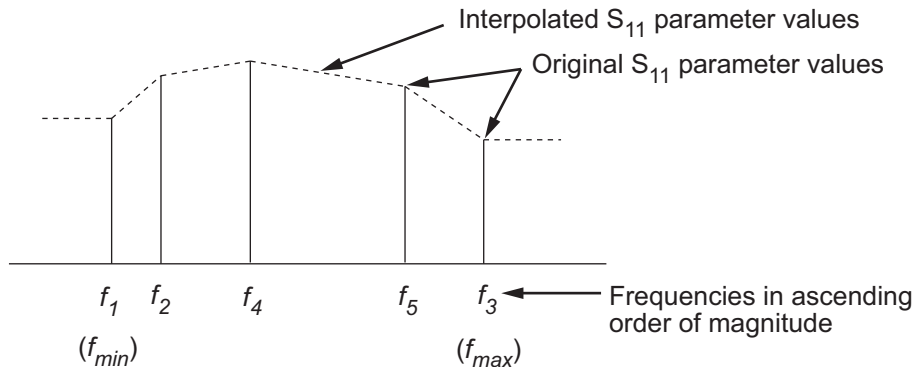



For more information, see “One-Dimensional Interpolation” and the `interp1` reference page in the MATLAB documentation.

As shown in the preceding diagram, the `analyze` method uses the parameter values at  $f_{min}$ , the minimum input frequency, for all frequencies smaller than  $f_{min}$ . It uses the parameters values at  $f_{max}$ , the maximum input frequency, for all frequencies greater than  $f_{max}$ . In both cases, the results may not be accurate, so you need to specify network parameter values over a range of frequencies that is wide enough to account for the component behavior.

The `analyze` method uses the S-parameters to calculate the group delay values at the frequencies specified in the `analyze` input argument `freq`, as described in the `analyze` reference page.

## Examples

```
data = rfckt.datafile;  
data.AnalyzedResult
```

```
ans =
```

```
    Name: 'Data object'  
    Freq: [202x1 double]  
    S_Parameters: [2x2x202 double]  
    GroupDelay: [202x1 double]  
    NF: [202x1 double]  
    OIP3: [202x1 double]  
    ZO: 50  
    ZS: 50  
    ZL: 50  
    IntpType: 'Linear'
```

# rfckt.datafile.File property

---

**Purpose** File containing circuit data

**Values** String

**Description** The name of the .snp, .ynp, .znp, or .hnp file describing the circuit, where n is the number of ports. The default file name is 'passive.s2p'.

**Examples**

```
data=rfckt.datafile;  
data.File='default.s2p'
```

```
data =
```

```
    Name: 'Data File'  
    nPort: 2  
    AnalyzedResult: [1x1 rfddata.data]  
    IntpType: 'Linear'  
    File: 'default.s2p'
```

**Purpose** Interpolation method

**Values** 'Linear' (default), 'Spline', or 'Cubic'

**Description** The analyze method is flexible in that it does not require the frequencies of the specified S-parameters to match the requested analysis frequencies. If needed, analyze applies the interpolation and extrapolation method specified in the IntpType property to the specified data to create a new set of data at the requested analysis frequencies. The following table lists the available interpolation methods and describes each one.

Method	Description
Linear (default)	Linear interpolation
Spline	Cubic spline interpolation
Cubic	Piecewise cubic Hermite interpolation

**Examples**

```
data = rfckt.datafile;  
data.IntpType = 'cubic';
```

# rfckt.datafile.Name property

---

<b>Purpose</b>	Object name
<b>Values</b>	'Data object'
<b>Description</b>	Read-only string that contains the name of the object.
<b>Examples</b>	<pre>data = rfckt.datafile; data.Name  ans =          Data object</pre>

**Purpose** Number of ports

**Values** 2

**Description** A read-only integer that indicates the object has two ports.

**Examples**

```
data = rfckt.datafile;  
data.nPort
```

```
ans =
```

```
2
```

# rfckt.delay.AnalyzedResult property

---

**Purpose** Computed S-parameters, noise figure, OIP3, and group delay values

**Values** `rfdata.data` object

**Description** Handle to an `rfdata.data` object that contains the S-parameters, noise figure, OIP3, and group delay values computed over the specified frequency range using the `analyze` method. This property is empty by default.

The `analyze` method treats the delay line, which can be lossy or lossless, as a 2-port linear network. It computes the `AnalyzedResult` property of the delay line using the data stored in the `rfckt.delay` object properties by calculating the S-parameters for the specified frequencies. This calculation is based on the values of the delay line's loss,  $\alpha$ , and time delay,  $D$ .

$$\begin{cases} S_{11} = 0 \\ S_{12} = e^{-p} \\ S_{21} = e^{-p} \\ S_{22} = 0 \end{cases}$$

Above,  $p = \alpha_a + i\beta$ , where  $\alpha_a$  is the attenuation coefficient and  $\beta$  is the wave number. The attenuation coefficient  $\alpha_a$  is related to the loss,  $\alpha$ , by

$$\alpha_a = -\ln(10^{\alpha/20})$$

and the wave number  $\beta$  is related to the time delay,  $D$ , by

$$\beta = 2\pi fD$$

where  $f$  is the frequency range specified in the `analyze` input argument `freq`.

The `analyze` method uses the S-parameters to calculate the group delay values at the frequencies specified in the `analyze` input argument `freq`, as described in the `analyze` reference page.

## Examples

Compute S-parameters, noise figure, OIP3, and group delay values:

```
del = rfckt.delay;  
analyze(del,[1e9,2e9,3e9]);  
del.AnalyzedResult
```

## rfckt.delay.Loss property

---

**Purpose** Delay line loss

**Values** Scalar

**Description** Line loss value, in decibels. Line loss is the reduction in strength of the signal as it travels over the delay line and must be nonnegative. The default is 0.

**Examples**

```
del = rfckt.delay;  
del.Loss = 10;
```



<b>Purpose</b>	Object name
<b>Values</b>	'Delay Line'
<b>Description</b>	Read-only string that contains the name of the object.
<b>Examples</b>	<pre>del = rfckt.delay; del.Name  ans =      Delay Line</pre>

# rfckt.delay.TimeDelay property

---

**Purpose** Delay introduced by line

**Values** Scalar

**Description** The amount of time delay, in seconds. The default is 1.0000e-012.

**Examples**

```
del = rfckt.delay;  
del.TimeDelay = 1e-9;
```

**Purpose** Characteristic impedance

**Values** Scalar

**Description** The characteristic impedance, in ohms, of the delay line. The default is 50 ohms.

**Examples**

```
del = rfckt.delay;  
del.Z0 = 75;
```

# rfckt.delay.nPort property

---

**Purpose**            Number of ports

**Values**            2

**Description**      A read-only integer that indicates the object has two ports.

**Examples**          `del = rfckt.delay;`  
                      `del.nPort`

`ans =`

`2`

# rfckt.hybrid.AnalyzedResult property

**Purpose** Computed S-parameters, noise figure, OIP3, and group delay values

**Values** `rfdata.data` object

**Description** Handle to an `rfdata.data` object that contains the S-parameters, noise figure, OIP3, and group delay values computed over the specified frequency range using the `analyze` method. This property is empty by default.

The `analyze` method computes the S-parameters of the `AnalyzedResult` property using the data stored in the `Ckts` property as follows:

- The `analyze` method first calculates the  $h$  matrix of the hybrid network. It starts by converting each component network's parameters to an  $h$  matrix. The following figure shows a hybrid connected network consisting of two 2-port networks, each represented by its  $h$  matrix,

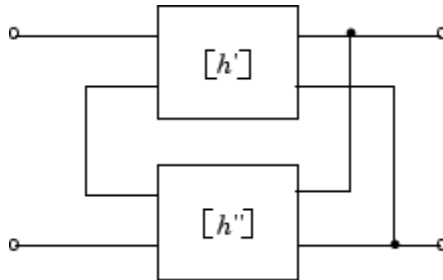

where

$$[h'] = \begin{bmatrix} h_{11}' & h_{12}' \\ h_{21}' & h_{22}' \end{bmatrix}$$
$$[h''] = \begin{bmatrix} h_{11}'' & h_{12}'' \\ h_{21}'' & h_{22}'' \end{bmatrix}$$

# rfckt.hybrid.AnalyzedResult property

---

- The analyze method then calculates the  $h$  matrix for the hybrid network by calculating the sum of the  $h$  matrices of the individual networks. The following equation illustrates the calculations for two 2-port networks.

$$[h] = \begin{bmatrix} h_{11}' + h_{11}'' & h_{12}' + h_{12}'' \\ h_{21}' + h_{21}'' & h_{22}' + h_{22}'' \end{bmatrix}$$

- Finally, analyze converts the  $h$  matrix of the hybrid network to S-parameters at the frequencies specified in the analyze input argument freq.

The analyze method uses the hybrid S-parameters to calculate the group delay values at the frequencies specified in the analyze input argument freq, as described in the analyze reference page.

## Examples

```
tx1 = rfckt.txline;  
tx2 = rfckt.txline;  
hyb = rfckt.hybrid('Ckts',{tx1,tx2})  
analyze(hyb,[1e9:1e7:2e9]);  
hyb.AnalyzedResult
```

```
ans =
```

```
      Name: 'Data object'  
      Freq: [101x1 double]  
S_Parameters: [2x2x101 double]  
  GroupDelay: [101x1 double]  
         NF: [101x1 double]  
      OIP3: [101x1 double]  
         Z0: 50  
         ZS: 50  
         ZL: 50  
      IntpType: 'Linear'
```

**Purpose** Circuit objects in network

**Values** Cell

**Description** Cell array containing handles to all circuit objects in the network. All circuits must be 2-port and linear. This property is empty by default.

**Examples**

```
tx1 = rfckt.txline;  
tx2 = rfckt.txline;  
hyb = rfckt.hybrid;  
hyb.Ckts = {tx1,tx2};  
hyb.Ckts
```

```
ans =
```

```
[1x1 rfckt.txline] [1x1 rfckt.txline]
```

# rfckt.hybrid.Name property

---

<b>Purpose</b>	Object name
<b>Values</b>	'Hybrid Connected Network'
<b>Description</b>	Read-only string that contains the name of the object.
<b>Examples</b>	<pre>hyb = rfckt.hybrid; hyb.Name  ans =      Hybrid Connected Network</pre>



<b>Purpose</b>	Number of ports
<b>Values</b>	2
<b>Description</b>	A read-only integer that indicates the object has two ports.
<b>Examples</b>	<pre>hyb = rfckt.hybrid; hyb.nPort  ans =       2</pre>

# rfckt.hybridg.AnalyzedResult property

---

**Purpose** Computed S-parameters, noise figure, OIP3, and group delay values

**Values** `rfdata.data` object

**Description** Handle to an `rfdata.data` object that contains the S-parameters, noise figure, OIP3, and group delay values computed over the specified frequency range using the `analyze` method. This property is empty by default.

The `analyze` method computes the S-parameters of the `AnalyzedResult` property using the data stored in the `Ckts` property as follows:

- 1 The `analyze` method first calculates the  $g$  matrix of the inverse hybrid network. It starts by converting each component network's parameters to a  $g$  matrix. The following figure shows an inverse hybrid connected network consisting of two 2-port networks, each represented by its  $g$  matrix,

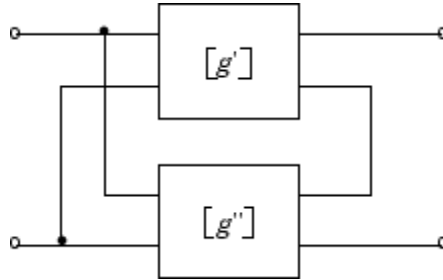

where

$$[g'] = \begin{bmatrix} g_{11}' & g_{12}' \\ g_{21}' & g_{22}' \end{bmatrix}$$
$$[g''] = \begin{bmatrix} g_{11}'' & g_{12}'' \\ g_{21}'' & g_{22}'' \end{bmatrix}$$

- The analyze method then calculates the  $g$  matrix for the inverse hybrid network by calculating the sum of the  $g$  matrices of the individual networks. The following equation illustrates the calculations for two 2-port networks.

$$[g] = \begin{bmatrix} g_{11}' + g_{11}'' & g_{12}' + g_{12}'' \\ g_{21}' + g_{21}'' & g_{22}' + g_{22}'' \end{bmatrix}$$

- Finally, analyze converts the  $g$  matrix of the inverse hybrid network to S-parameters at the frequencies specified in the analyze input argument freq.

The analyze method uses the inverse hybrid S-parameters to calculate the group delay values at the frequencies specified in the analyze input argument freq, as described in the analyze reference page.

## Examples

```
tx1 = rfckt.txline;
tx2 = rfckt.txline;
invhyb = rfckt.hybridg('Ckts',{tx1,tx2})
analyze(invhyb,[1e9:1e7:2e9]);
invhyb.AnalyzedResult
```

```
ans =
```

```
      Name: 'Data object'
      Freq: [101x1 double]
S_Parameters: [2x2x101 double]
  GroupDelay: [101x1 double]
         NF: [101x1 double]
        OIP3: [101x1 double]
           Z0: 50
           ZS: 50
           ZL: 50
      IntpType: 'Linear'
```

# rfckt.hybridg.Ckts property

---

<b>Purpose</b>	Circuit objects in network
<b>Values</b>	Cell
<b>Description</b>	Cell array containing handles to all circuit objects in the network. All circuits must be 2-port and linear. This property is empty by default.
<b>Examples</b>	<pre>tx1 = rfckt.txline; tx2 = rfckt.txline; invhyb = rfckt.hybridg; invhyb.Ckts = {tx1,tx2}; invhyb.Ckts  ans =      [1x1 rfckt.txline] [1x1 rfckt.txline]</pre>

## rfckt.hybridg.Name property

---

<b>Purpose</b>	Object name
<b>Values</b>	'Hybrid G Connected Network'
<b>Description</b>	Read-only string that contains the name of the object.
<b>Examples</b>	<pre>invhyb = rfckt.hybridg; invhyb.Name  ans =      Hybrid G Connected Network</pre>

# rfckt.hybridg.nPort property

---

**Purpose**            Number of ports

**Values**            2

**Description**      A read-only integer that indicates the object has two ports.

**Examples**            `invhyb = rfckt.hybridg;`  
                          `invhyb.nPort`

`ans =`

`2`

# rfckt.lcbandpasspi.AnalyzedResult property

---

<b>Purpose</b>	Computed S-parameters, noise figure, OIP3, and group delay values
<b>Values</b>	rfdata.data object
<b>Description</b>	Handle to an rfdata.data object that contains the S-parameters, noise figure, OIP3, and group delay values computed over the specified frequency range using the analyze method. This property is empty by default.
<b>Examples</b>	<pre>filter = rfckt.lcbandpasspi; analyze(filter,[1e9,2e9,3e9]); filter.AnalyzedResult  ans =      Name: 'Data object'     Freq: [3x1 double]     S_Parameters: [2x2x3 double]     GroupDelay: [3x1 double]     NF: [3x1 double]     OIP3: [3x1 double]     ZO: 50     ZS: 50     ZL: 50     IntpType: 'Linear'</pre>

# rfckt.lcbandpasspi.C property

---

**Purpose** Capacitance data

**Values** Vector

**Description** Capacitance values in farads, in order from source to load, of all capacitors in the network. The length of the capacitance vector must be equal to the length of the vector you provide for 'L'. All values must be strictly positive. The default is [0.3579e-10, 0.0118e-10, 0.3579e-10].

**Examples**

```
filter=rfckt.lcbandpasspi;  
filter.C = [10.1 4.5 14.2]*1e-12;
```



**Purpose** Inductance data

**Values** Vector

**Description** Inductance values in henries, in order from source to load, of all inductors in the network. The length of the inductance vector must be equal to the length of the vector you provide for 'C'. All values must be strictly positive. The default is [0.0144e-7, 0.4395e-7, 0.0144e-7].

**Examples**

```
filter = rfckt.lcbandpasspi;  
filter.L = [3.1 5.9 16.3]*1e-9;
```

# rfckt.lcbandpasspi.Name property

---

<b>Purpose</b>	Object name
<b>Values</b>	'LC Bandpass Pi'
<b>Description</b>	Read-only string that contains the name of the object.
<b>Examples</b>	<pre>filter = rfckt.lcbandpasspi; filter.Name  ans =          LC Bandpass Pi</pre>

# rfckt.lcbandpasspi.nPort property

---

**Purpose** Number of ports

**Values** 2

**Description** A read-only integer that indicates the object has two ports.

**Examples**

```
filter = rfckt.lcbandpasspi;  
filter.nPort
```

```
ans =
```

```
2
```

# rfckt.lcbandpasstee.AnalyzedResult property

---

**Purpose** Computed S-parameters, noise figure, OIP3, and group delay values

**Values** rfdata.data object

**Description** Handle to an rfdata.data object that contains the S-parameters, noise figure, OIP3, and group delay values computed over the specified frequency range using the analyze method. This property is empty by default.

**Examples**

```
filter = rfckt.lcbandpasstee;
analyze(filter,[1e9,2e9,3e9]);
filter.AnalyzedResult
```

```
ans =
```

```
Name: 'Data object'
Freq: [3x1 double]
S_Parameters: [2x2x3 double]
GroupDelay: [3x1 double]
NF: [3x1 double]
OIP3: [3x1 double]
ZO: 50
ZS: 50
ZL: 50
IntpType: 'Linear'
```

## rfckt.lcbandpasstee.C property

---

<b>Purpose</b>	Capacitance data
<b>Values</b>	Vector
<b>Description</b>	Capacitance values in farads, in order from source to load, of all capacitors in the network. The length of the capacitance vector must be equal to the length of the vector you provide for 'L'. All values must be strictly positive. The default is [0.0186e-10, 0.1716e-10, 0.0186e-10].
<b>Examples</b>	<pre>filter=rfckt.lcbandpasstee; filter.C = [10.1 4.5 14.2]*1e-12;</pre>

# rfckt.lcbandpasstee.L property

---

**Purpose** Inductance data

**Values** Vector

**Description** Inductance values in henries, in order from source to load, of all inductors in the network. The length of the inductance vector must be equal to the length of the vector you provide for 'C'. All values must be strictly positive. The default is [0.2781e-7, 0.0301e-7, 0.2781e-7].

**Examples**

```
filter = rfckt.lcbandpasstee;  
filter.L = [3.1 5.9 16.3]*1e-9;
```

# rfckt.lcbandpasstee.Name property

---

<b>Purpose</b>	Object name
<b>Values</b>	'LC Bandpass Tee'
<b>Description</b>	Read-only string that contains the name of the object.
<b>Examples</b>	<pre>filter = rfckt.lcbandpasstee; filter.Name  ans =  LC Bandpass Tee</pre>

# rfckt.lcbandpasstee.nPort property

---

**Purpose**            Number of ports

**Values**            2

**Description**      A read-only integer that indicates the object has two ports.

**Examples**            `filter = rfckt.lcbandpasstee;`  
                          `filter.nPort`

`ans =`

`2`



# rfckt.lcbandstoppi.AnalyzedResult property

---

<b>Purpose</b>	Computed S-parameters, noise figure, OIP3, and group delay values
<b>Values</b>	rfdata.data object
<b>Description</b>	Handle to an rfdata.data object that contains the S-parameters, noise figure, OIP3, and group delay values computed over the specified frequency range using the analyze method. This property is empty by default.
<b>Examples</b>	<pre>filter = rfckt.lcbandstoppi; analyze(filter,[1e9,2e9,3e9]); filter.AnalyzedResult  ans =      Name: 'Data object'     Freq: [3x1 double]     S_Parameters: [2x2x3 double]     GroupDelay: [3x1 double]     NF: [3x1 double]     OIP3: [3x1 double]     ZO: 50     ZS: 50     ZL: 50     IntpType: 'Linear'</pre>

# rfckt.lcbandstoppi.C property

---

**Purpose** Capacitance data

**Values** Vector

**Description** Capacitance values in farads, in order from source to load, of all capacitors in the network. The length of the capacitance vector must be equal to the length of the vector you provide for 'L'. All values must be strictly positive. The default is [0.0184e-10, 0.2287e-10, 0.0184e-10].

**Examples**

```
filter=rfckt.lcbandstoppi;  
filter.C = [10.1 4.5 14.2]*1e-12;
```

**Purpose** Inductance data

**Values** Vector

**Description** Inductance values in henries, in order from source to load, of all inductors in the network. The length of the inductance vector must be equal to the length of the vector you provide for 'C'. All values must be strictly positive. The default is [0.2809e-7, 0.0226e-7, 0.2809e-7].

**Examples**

```
filter = rfckt.lcbandstoppi;  
filter.L = [3.1 5.9 16.3]*1e-9;
```

# rfckt.lcbandstoppi.Name property

---

**Purpose** Object name

**Values** 'LC Bandstop Pi'

**Description** Read-only string that contains the name of the object.

**Examples**

```
filter = rfckt.lcbandstoppi;  
filter.Name
```

```
ans =
```

```
LC Bandstop Pi
```

# rfckt.lcbandstoppi.nPort property

---

**Purpose** Number of ports

**Values** 2

**Description** A read-only integer that indicates the object has two ports.

**Examples**

```
filter = rfckt.lcbandstoppi;  
filter.nPort
```

```
ans =
```

```
2
```

# rfckt.lcbandstoptee.AnalyzedResult property

---

**Purpose** Computed S-parameters, noise figure, OIP3, and group delay values

**Values** rfdata.data object

**Description** Handle to an rfdata.data object that contains the S-parameters, noise figure, OIP3, and group delay values computed over the specified frequency range using the analyze method. This property is empty by default.

**Examples**

```
filter = rfckt.lcbandstoptee;
analyze(filter,[1e9,2e9,3e9]);
filter.AnalyzedResult
```

```
ans =
```

```
Name: 'Data object'
Freq: [3x1 double]
S_Parameters: [2x2x3 double]
GroupDelay: [3x1 double]
NF: [3x1 double]
OIP3: [3x1 double]
Z0: 50
ZS: 50
ZL: 50
IntpType: 'Linear'
```

<b>Purpose</b>	Capacitance data
<b>Values</b>	Vector
<b>Description</b>	Capacitance values in farads, in order from source to load, of all capacitors in the network. The length of the capacitance vector must be equal to the length of the vector you provide for 'L'. All values must be strictly positive. The default is [0.1852e-10, 0.0105e-10, 0.1852e-10].
<b>Examples</b>	<pre>filter=rfckt.lcbandstoptee; filter.C = [10.1 4.5 14.2]*1e-12;</pre>

# rfckt.lcbandstoptee.L property

---

**Purpose** Inductance data

**Values** Vector

**Description** Inductance values in henries, in order from source to load, of all inductors in the network. The length of the inductance vector must be equal to the length of the vector you provide for 'C'. All values must be strictly positive. The default is [0.0279e-7, 0.4932e-7, 0.0279e-7].

**Examples**

```
filter = rfckt.lcbandstoptee;  
filter.L = [3.1 5.9 16.3]*1e-9;
```



# rfckt.lcbandstoptee.Name property

---

<b>Purpose</b>	Object name
<b>Values</b>	'LC Bandstop Tee'
<b>Description</b>	Read-only string that contains the name of the object.
<b>Examples</b>	<pre>filter = rfckt.lcbandstoptee; filter.Name  ans =      LC Bandstop Tee</pre>

# rfckt.lcbandstoptee.nPort property

---

**Purpose**            Number of ports

**Values**            2

**Description**      A read-only integer that indicates the object has two ports.

**Examples**            `filter = rfckt.lcbandstoptee;`  
                          `filter.nPort`

`ans =`

`2`

# rfckt.lchighpasspi.AnalyzedResult property

---

**Purpose** Computed S-parameters, noise figure, OIP3, and group delay values

**Values** rfdata.data object

**Description** Handle to an rfdata.data object that contains the S-parameters, noise figure, OIP3, and group delay values computed over the specified frequency range using the analyze method. This property is empty by default.

**Examples**

```
filter = rfckt.lchighpasspi;
analyze(filter,[1e9,2e9,3e9]);
filter.AnalyzedResult
```

ans =

```
Name: 'Data object'
Freq: [3x1 double]
S_Parameters: [2x2x3 double]
GroupDelay: [3x1 double]
NF: [3x1 double]
OIP3: [3x1 double]
ZO: 50
ZS: 50
ZL: 50
IntpType: 'Linear'
```

# rfckt.lchighpasspi.C property

---

**Purpose** Capacitance data

**Values** Vector

**Description** Capacitance values in farads, in order from source to load, of all capacitors in the network. The length of the capacitance vector must be equal to the length of the vector you provide for 'L'. All values must be strictly positive. The default is [0.1188e-5, 0.1188e-5].

**Examples**

```
filter=rfckt.lchighpasspi;  
filter.C = [10.1 4.5 14.2]*1e-12;
```

**Purpose** Inductance data

**Values** Vector

**Description** Inductance values in henries, in order from source to load, of all inductors in the network. The length of the inductance vector must be equal to the length of the vector you provide for 'C'. All values must be strictly positive. The default is [2.2363e-9].

**Examples**

```
filter = rfckt.lchighpasspi;  
filter.L = [3.1 5.9 16.3]*1e-9;
```

# rfckt.lchighpasspi.Name property

---

<b>Purpose</b>	Object name
<b>Values</b>	'LC Highpass Pi'
<b>Description</b>	Read-only string that contains the name of the object.
<b>Examples</b>	<pre>filter = rfckt.lchighpasspi; filter.Name  ans =        LC Highpass Pi</pre>

# rfckt.lchighpasspi.nPort property

---

**Purpose** Number of ports

**Values** 2

**Description** A read-only integer that indicates the object has two ports.

**Examples**

```
filter = rfckt.lchighpasspi;  
filter.nPort
```

```
ans =
```

```
2
```

# rfckt.lchighpasstee.AnalyzedResult property

---

**Purpose** Computed S-parameters, noise figure, OIP3, and group delay values

**Values** rfdata.data object

**Description** Handle to an rfdata.data object that contains the S-parameters, noise figure, OIP3, and group delay values computed over the specified frequency range using the analyze method. This property is empty by default.

**Examples**

```
filter = rfckt.lchighpasstee;  
analyze(filter,[1e9,2e9,3e9]);  
filter.AnalyzedResult
```

```
ans =
```

```
Name: 'Data object'  
Freq: [3x1 double]  
S_Parameters: [2x2x3 double]  
GroupDelay: [3x1 double]  
NF: [3x1 double]  
OIP3: [3x1 double]  
Z0: 50  
ZS: 50  
ZL: 50  
IntpType: 'Linear'
```



**Purpose** Capacitance data

**Values** Vector

**Description** Capacitances values in farads, in order from source to load, of all capacitors in the network. The length of the capacitance vector must be equal to the length of the vector you provide for 'L'. All values must be strictly positive. The default is [0.4752e-9, 0.4752e-9].

**Examples**

```
filter=rfckt.lchighpasstee;  
filter.C = [10.1 4.5 14.2]*1e-12;
```

# rfckt.lchighpasstee.L property

---

**Purpose** Inductance data

**Values** Vector

**Description** Inductance values in henries, in order from source to load, of all inductors in the network. The length of the inductance vector must be equal to the length of the vector you provide for 'C'. All values must be strictly positive. The default is [5.5907e-6].

**Examples**

```
filter = rfckt.lchighpasstee;  
filter.L = [3.1 5.9 16.3]*1e-9;
```

# rfckt.lchighpasstee.Name property

---

<b>Purpose</b>	Object name
<b>Values</b>	'LC Highpass Tee'
<b>Description</b>	Read-only string that contains the name of the object.
<b>Examples</b>	<pre>filter = rfckt.lchighpasstee; filter.Name  ans =        LC Highpass Tee</pre>

## rfckt.lchighpasstee.nPort property

---

<b>Purpose</b>	Number of ports
<b>Values</b>	2
<b>Description</b>	A read-only integer that indicates the object has two ports.
<b>Examples</b>	<pre>filter = rfckt.lchighpasstee; filter.nPort  ans =       2</pre>

# rfckt.lclowpasspi.AnalyzedResult property

---

**Purpose** Computed S-parameters, noise figure, OIP3, and group delay values

**Values** rfdata.data object

**Description** Handle to an rfdata.data object that contains the S-parameters, noise figure, OIP3, and group delay values computed over the specified frequency range using the analyze method. This property is empty by default.

**Examples**

```
filter = rfckt.lclowpasspi;
analyze(filter,[1e9,2e9,3e9]);
filter.AnalyzedResult
```

```
ans =
```

```
Name: 'Data object'
Freq: [3x1 double]
S_Parameters: [2x2x3 double]
GroupDelay: [3x1 double]
NF: [3x1 double]
OIP3: [3x1 double]
ZO: 50
ZS: 50
ZL: 50
IntpType: 'Linear'
```

# rfckt.lclowpasspi.C property

---

**Purpose** Capacitance data

**Values** Vector

**Description** Capacitance values in farads, in order from source to load, of all capacitors in the network. The length of the capacitance vector must be equal to or one greater than the length of the vector you provide for 'L'. All values must be strictly positive. The default is [0.5330e-8, 0.5330e-8].

**Examples**

```
filter=rfckt.lclowpasspi;  
filter.C = [10.1 4.5 14.2]*1e-12;
```

**Purpose** Inductance data

**Values** Vector

**Description** Inductance values in henries, in order from source to load, of all inductors in the network. The length of the inductance vector must be equal to or one less than the length of the vector you provide for 'C'. All values must be strictly positive. The default is [2.8318e-6].

**Examples**

```
filter = rfckt.lclowpasspi;  
filter.L = [3.1 5.9 16.3]*1e-9;
```

# rfckt.lclowpasspi.Name property

---

**Purpose** Object name

**Values** 'LC Lowpass Pi'

**Description** Read-only string that contains the name of the object.

**Examples**

```
filter = rfckt.lclowpasspi;  
filter.Name
```

```
ans =
```

```
LC Lowpass Pi
```



**Purpose** Number of ports

**Values** 2

**Description** A read-only integer that indicates the object has two ports.

**Examples**

```
filter = rfckt.lclowpasspi;  
filter.nPort
```

```
ans =
```

```
2
```

# rfckt.lclowpasstee.AnalyzedResult property

---

**Purpose** Computed S-parameters, noise figure, OIP3, and group delay values

**Values** rfdata.data object

**Description** Handle to an rfdata.data object that contains the S-parameters, noise figure, OIP3, and group delay values computed over the specified frequency range using the analyze method. This property is empty by default.

**Examples**

```
filter = rfckt.lclowpasstee;
analyze(filter,[1e9,2e9,3e9]);
filter.AnalyzedResult
```

```
ans =
```

```
Name: 'Data object'
Freq: [3x1 double]
S_Parameters: [2x2x3 double]
GroupDelay: [3x1 double]
NF: [3x1 double]
OIP3: [3x1 double]
ZO: 50
ZS: 50
ZL: 50
IntpType: 'Linear'
```

**Purpose** Capacitance data

**Values** Vector

**Description** Capacitance values in farads, in order from source to load, of all capacitors in the network. The length of the capacitance vector must be equal to or one less than the length of the vector you provide for 'L'. All values must be strictly positive. The default is [1.1327e-9].

**Examples**

```
filter=rfckt.lclowpasstee;  
filter.C = [10.1 4.5 14.2]*1e-12;
```

# rfckt.lclowpasstee.L property

---

**Purpose** Inductance data

**Values** Vector

**Description** Inductance values in henries, in order from source to load, of all inductors in the network. The length of the inductance vector must be equal to or one greater than the length of the vector you provide for 'C'. All values must be strictly positive. The default is [0.1332e-4, 0.1332e-4].

**Examples**

```
filter = rfckt.lclowpasstee;  
filter.L = [3.1 5.9 16.3]*1e-9;
```

# rfckt.lclowpasstee.Name property

---

<b>Purpose</b>	Object name
<b>Values</b>	'LC Lowpass Tee'
<b>Description</b>	Read-only string that contains the name of the object.
<b>Examples</b>	<pre>filter = rfckt.lclowpasstee; filter.Name  ans =      LC Lowpass Tee</pre>

# rfckt.lclowpasstee.nPort property

---

**Purpose**            Number of ports

**Values**            2

**Description**      A read-only integer that indicates the object has two ports.

**Examples**            `filter = rfckt.lclowpasstee;`  
                          `filter.nPort`

`ans =`

`2`

# rfckt.microstrip.AnalyzedResult property

**Purpose** Computed S-parameters, noise figure, OIP3, and group delay values

**Values** rfdata.data object

**Description** Handle to an rfdata.data object that contains the S-parameters, noise figure, OIP3, and group delay values computed over the specified frequency range using the analyze method. This property is empty by default.

The analyze method treats the microstrip line as a 2-port linear network and models the line as a transmission line with optional stubs. The analyze method computes the AnalyzedResult property of the transmission line using the data stored in the rfckt.microstrip object properties as follows:

- 

If you model the transmission line as a stubless line, the analyze method first calculates the ABCD-parameters at each frequency contained in the modeling frequencies vector. It then uses the abcd2s function to convert the ABCD-parameters to S-parameters.

The analyze method calculates the ABCD-parameters using the physical length of the transmission line,  $d$ , and the complex propagation constant,  $k$ , using the following equations:

$$A = \frac{e^{kd} + e^{-kd}}{2}$$

$$B = \frac{Z_0 * (e^{kd} - e^{-kd})}{2}$$

$$C = \frac{e^{kd} - e^{-kd}}{2 * Z_0}$$

$$D = \frac{e^{kd} + e^{-kd}}{2}$$

## rfckt.microstrip.AnalyzedResult property

$Z_0$  and  $k$  are vectors whose elements correspond to the elements of  $f$ , the vector of frequencies specified in the `analyze` input argument `freq`. Both can be expressed in terms of the specified conductor strip width, substrate height, conductor strip thickness, relative permittivity constant, conductivity, and dielectric loss tangent of the microstrip line, as described in [1].

- If you model the transmission line as a shunt or series stub, the `analyze` method first calculates the ABCD-parameters at the specified frequencies. It then uses the `abcd2s` function to convert the ABCD-parameters to S-parameters.

When you set the `StubMode` property to 'Shunt', the 2-port network consists of a stub transmission line that you can terminate with either a short circuit or an open circuit as shown in the following figure.

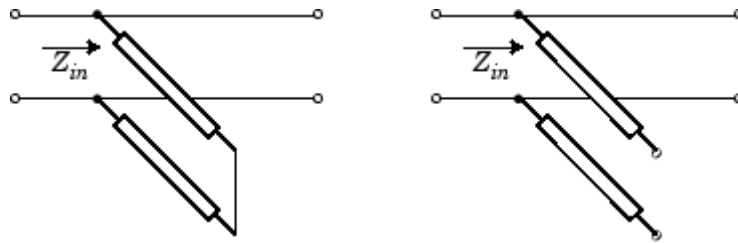

$Z_{in}$  is the input impedance of the shunt circuit. The ABCD-parameters for the shunt stub are calculated as:

$$\begin{aligned} A &= 1 \\ B &= 0 \\ C &= 1 / Z_{in} \\ D &= 1 \end{aligned}$$

When you set the `StubMode` property to 'Series', the 2-port network consists of a series transmission line that you can terminate with either a short circuit or an open circuit as shown in the following figure.



# rfckt.microstrip.AnalyzedResult property

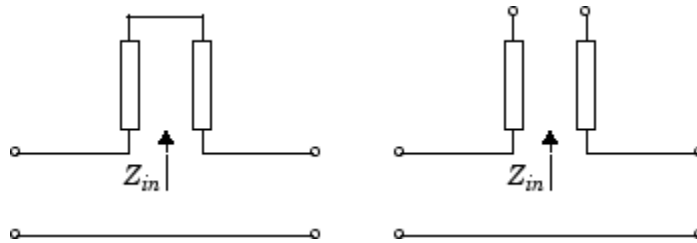

$Z_{in}$  is the input impedance of the series circuit. The ABCD-parameters for the series stub are calculated as:

$$\begin{aligned}A &= 1 \\B &= Z_{in} \\C &= 0 \\D &= 1\end{aligned}$$

The analyze method uses the S-parameters to calculate the group delay values at the frequencies specified in the analyze input argument freq, as described in the analyze reference page.

## Examples

```
tx1 = rfckt.microstrip;  
analyze(tx1,[1e9,2e9,3e9]);  
tx1.AnalyzedResult
```

```
ans =
```

```
Name: 'Data object'  
Freq: [3x1 double]  
S_Parameters: [2x2x3 double]  
GroupDelay: [3x1 double]  
NF: [3x1 double]  
OIP3: [3x1 double]  
Z0: 50  
ZS: 50  
ZL: 50  
IntpType: 'Linear'
```

# rfckt.microstrip.EpsilonR property

---

**Purpose** Relative permittivity of dielectric

**Values** Scalar

**Description** The ratio of the permittivity of the dielectric,  $\epsilon$ , to the permittivity of free space,  $\epsilon_0$ . The default value is 9.8.

**Examples** Change the relative permittivity of the dielectric:

```
tx1=rfckt.microstrip;  
tx1.EpsilonR=2.7;
```

## rfckt.microstrip.Height property

---

<b>Purpose</b>	Dielectric thickness
<b>Values</b>	Scalar
<b>Description</b>	Physical height, in meters, of the dielectric on which the microstrip resides. The default is $6.35e-4$ .
<b>Examples</b>	<pre>tx1=rfckt.microstrip; tx1.Height=0.001;</pre>

# rfckt.microstrip.LineLength property

---

**Purpose** Microstrip line length

**Values** Scalar

**Description** The physical length of the transmission line in meters. The default is 0.01.

**Examples**

```
tx1 = rfckt.microstrip;  
tx1.LineLength = 0.001;
```

## rfckt.microstrip.LossTangent property

---

**Purpose** Tangent of loss angle

**Values** Scalar

**Description** The loss angle tangent of the dielectric. The default is 0.

**Examples**

```
tx1 = rfckt.microstrip;  
tx1.LossTangent
```

```
ans =
```

```
0
```

# rfckt.microstrip.Name property

---

**Purpose** Object name

**Values** 'Microstrip Waveguide Transmission Line'

**Description** Read-only string that contains the name of the object.

**Examples**

```
tx1 = rfckt.microstrip;  
tx1.Name
```

```
ans =
```

```
Microstrip Transmission Line
```

# rfckt.microstrip.SigmaCond property

---

<b>Purpose</b>	Conductor conductivity
<b>Values</b>	Scalar
<b>Description</b>	Conductivity, in Siemens per meter (S/m), of the conductor. The default is Inf.
<b>Examples</b>	<pre>tx1=rfckt.microstrip; tx1.SigmaCond=5.81e7;</pre>

## rfckt.microstrip.StubMode property

---

<b>Purpose</b>	Type of stub
<b>Values</b>	'NotAStub' (default), 'Series', or 'Shunt'
<b>Description</b>	String that specifies what type of stub, if any, to include in the transmission line model.
<b>Examples</b>	<pre>tx1 = rfckt.microstrip; tx1.StubMode = 'Series';</pre>



# rfckt.microstrip.Termination property

---

<b>Purpose</b>	Stub transmission line termination
<b>Values</b>	'NotApplicable' (default), 'Open', or 'Short'.
<b>Description</b>	String that specifies what type of termination to use for 'Shunt' and 'Series' stub modes. Termination is ignored if the line has no stub. Use 'NotApplicable' when StubMode is 'NotAStub'.
<b>Examples</b>	<pre>tx1 = rfckt.microstrip; tx1.StubMode = 'Series'; tx1.Termination = 'Short';</pre>

# rfckt.microstrip.Thickness property

---

**Purpose**            Microstrip thickness

**Values**            Scalar

**Description**      Physical thickness, in meters, of the microstrip. The default is  $5.0e-6$ .

**Examples**            `tx1=rfckt.microstrip;`  
                          `tx1.Thickness=2e-6;`

## rfckt.microstrip.Width property

---

**Purpose** Parallel-plate width

**Values** Scalar

**Description** Physical width, in meters, of the parallel-plate. The default is  $6.0e-4$ .

**Examples**

```
tx1=rfckt.microstrip;  
tx1.Thickness=2e-4;
```

# rfckt.microstrip.nPort property

---

**Purpose**            Number of ports

**Values**            2

**Description**      A read-only integer that indicates the object has two ports.

**Examples**            `tx1 = rfckt.microstrip;`  
                          `tx1.nPort`

`ans =`

`2`

# rfckt.mixer.AnalyzedResult property

---

**Purpose** Computed S-parameters, noise figure, OIP3, and group delay values

**Values** `rfdata.data` object

**Description** Handle to an `rfdata.data` object that contains the S-parameters, noise figure, OIP3, and group delay values computed over the specified frequency range using the `analyze` method. The default is a 1-by-1 `rfdata.data` object that contains the S-parameters, noise figure, OIP3, and group delay values that result from analyzing the values stored in the `default.amp` file at the frequencies stored in this file.

The `analyze` method computes the `AnalyzedResult` property using the data stored in the `rfckt.mixer` object properties as follows:

- The `analyze` method uses the data stored in the `'NoiseData'` property of the `rfckt.mixer` object to calculate the noise figure.
- The `analyze` method uses the data stored in the `'PhaseNoiseLevel'` property of the `rfckt.mixer` object to calculate phase noise. The `analyze` method first generates additive white Gaussian noise (AWGN) and filters the noise with a digital FIR filter. It then adds the resulting noise to the angle component of the input signal.

The method computes the digital filter by:

- 1** Interpolating the specified phase noise amplitude to determine the phase noise values at the modeling frequencies.
  - 2** Taking the IFFT of the resulting phase noise spectrum to get the coefficients of the FIR filter.
- The `analyze` method uses the data stored in the `'NonlinearData'` property of the `rfckt.mixer` object to calculate OIP3.

If power data exists in the `'NonlinearData'` property, the block extracts the AM/AM and AM/PM nonlinearities from the power data.

If the `'NonlinearData'` property contains only IP3 data, the method computes and adds the nonlinearity by:

## rfckt.mixer.AnalyzedResult property

---

- 1 Using the third-order input intercept point value in dBm to compute the factor,  $f$ , that scales the input signal before the mixer object applies the nonlinearity:

$$F_{AM/AM}(u) = u - \frac{u^3}{3}$$

- 2 Computing the scaled input signal by multiplying the mixer input signal by  $f$ .
- 3 Limiting the scaled input signal to a maximum value of 1.
- 4 Applying an AM/AM conversion to the mixer gain, according to the following cubic polynomial equation:

$$F_{AM/AM}(u) = u - \frac{u^3}{3}$$

where  $u$  is the magnitude of the scaled input signal, which is a unitless normalized input voltage.

- The `analyze` method uses the data stored in the 'NetworkData' property of the `rfckt.mixer` object to calculate the group delay values of the mixer at the frequencies specified in `freq`, as described in the `analyze` reference page.
- The `analyze` method uses the data stored in the 'NetworkData' property of the `rfckt.mixer` object to calculate the S-parameter values of the mixer at the frequencies specified in `freq`. If the 'NetworkData' property contains network Y- or Z-parameters, the `analyze` method first converts the parameters to S-parameters. Using the interpolation method you specify with the 'IntpType' property, the `analyze` method interpolates the S-parameter values to determine their values at the specified frequencies.

Specifically, the `analyze` method orders the S-parameters according to the ascending order of their frequencies,  $f_n$ . It then interpolates the S-parameters, using the MATLAB `interp1` function. For example, the curve in the following diagram illustrates the result of interpolating the  $S_{11}$  parameters at five different frequencies.

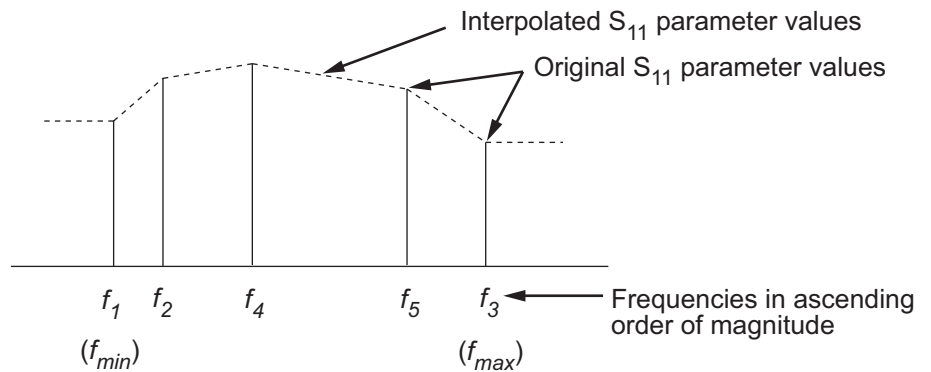

For more information, see “One-Dimensional Interpolation” and the `interp1` reference page in the MATLAB documentation.

As shown in the preceding diagram, the `analyze` method uses the parameter values at  $f_{min}$ , the minimum input frequency, for all frequencies smaller than  $f_{min}$ . It uses the parameters values at  $f_{max}$ , the maximum input frequency, for all frequencies greater than  $f_{max}$ . In both cases, the results may not be accurate, so you need to specify network parameter values over a range of frequencies that is wide enough to account for the mixer behavior.

RF Toolbox software computes the reflected wave at the mixer input ( $b_1$ ) and at the mixer output ( $b_2$ ) from the interpolated S-parameters as

$$\begin{bmatrix} b_1(f_{in}) \\ b_2(f_{out}) \end{bmatrix} = \begin{bmatrix} S_{11} & S_{12} \\ S_{21} & S_{22} \end{bmatrix} \begin{bmatrix} a_1(f_{in}) \\ a_2(f_{out}) \end{bmatrix}$$

where

- $f_{in}$  and  $f_{out}$  are the mixer input and output frequencies, respectively.
- $a_1$  and  $a_2$  are the incident waves at the mixer input and output, respectively.

The interpolated  $S_{21}$  parameter values describe the conversion gain as a function of frequency, referred to the mixer input frequency.

# rfckt.mixer.AnalyzedResult property

---

## Examples

```
mix1 = rfckt.mixer;  
mix1.AnalyzedResult
```

```
ans =
```

```
Name: 'Data object'  
Freq: [191x1 double]  
S_Parameters: [2x2x191 double]  
GroupDelay: [191x1 double]  
NF: [191x1 double]  
OIP3: [191x1 double]  
ZO: 50  
ZS: 50  
ZL: 50  
IntpType: 'Linear'
```



**Purpose** Local oscillator frequency

**Values** Scalar

**Description** Frequency, in hertz, of the local oscillator. The default is 1.0e+9.

If the MixerType property is set to 'Downconverter', the mixer output frequency is calculated as  $f_{out} = f_{in} - f_{lo}$ . If the MixerType property is set to 'Upconverter', the mixer output frequency is calculated as  $f_{out} = f_{in} + f_{lo}$ .

**Examples**

```
mix1 = rfckt.mixer;  
mix1.FLO = 1.6e9;
```

# rfckt.mixer.FreqOffset property

---

**Purpose** Frequency offset data

**Values** Vector

**Description** Vector specifying the frequency offset values, in hertz, that correspond to the phase noise level values specified by the `PhaseNoiseLevel` property. This property is empty by default.

**Examples**

```
mix1 = rfckt.mixer;  
mix1.FreqOffset = [1.6e6, 2.1e6];
```

**Purpose** Interpolation method

**Values** 'Linear' (default), 'Spline', or 'Cubic'

**Description** The analyze method is flexible in that it does not require the frequencies of the specified S-parameters to match the requested analysis frequencies. If needed, analyze applies the interpolation and extrapolation method specified in the IntpType property to the specified data to create a new set of data at the requested analysis frequencies. The following table lists the available interpolation methods and describes each one.

Method	Description
Linear (default)	Linear interpolation
Spline	Cubic spline interpolation
Cubic	Piecewise cubic Hermite interpolation

## Examples

```
mix1 = rfckt.mixer;  
mix1.IntpType = 'cubic'
```

```
mix1 =
```

```
Name: 'Mixer'  
nPort: 2  
AnalyzedResult: [1x1 rfdata.data]  
IntpType: 'Cubic'  
NetworkData: [1x1 rfdata.network]  
NoiseData: [1x1 rfdata.noise]  
NonlinearData: Inf  
MixerType: 'downconverter'  
FLO: 1.0000e+009  
FreqOffset: []  
PhaseNoiseLevel: []
```

# rfckt.mixer.MixerSpurData property

---

**Purpose** Data from mixer spur table

**Values** rfddata.mixerspurspur object

**Description** An rfddata.mixerspurspur object that stores data from an intermodulation table. This property is empty by default.

## Examples

```
mix1 = rfckt.mixer;  
mix1.MixerSpurData=rfddata.mixerspurspur('Data',[2 5; 1 0],...  
                                           'PinRef',3,'PLORef',5)  
mix1 =
```

```
          Name: 'Mixer'  
          nPort: 2  
AnalyzedResult: [1x1 rfddata.data]  
          IntpType: 'Linear'  
          NetworkData: [1x1 rfddata.network]  
          NoiseData: [1x1 rfddata.noise]  
          NonlinearData: Inf  
          MixerSpurData: [1x1 rfddata.mixerspurspur]  
          MixerType: 'Downconverter'  
          FLO: 1.0000e+009  
          FreqOffset: []  
          PhaseNoiseLevel: []
```

## rfckt.mixer.MixerType property

---

<b>Purpose</b>	Type of mixer
<b>Values</b>	'Downconverter' (default) or 'Upconverter'
<b>Description</b>	String specifying whether the mixer downconverting or upconverting.
<b>Examples</b>	<pre>mix1 = rfckt.mixer; mix1.MixerType = 'Upconverter';</pre>

# rfckt.mixer.Name property

---

**Purpose** Object name

**Values** 'Mixer'

**Description** Read-only string that contains the name of the object.

**Examples**

```
mix1 = rfckt.mixer;
mix1.Name

ans =

    Mixer
```

# rfckt.mixer.NetworkData property

---

**Purpose** Network parameter information

**Values** rfdata.network object

**Description** An rfdata.network object that stores network parameter data. The default network parameter values are taken from the 'default.s2p' data file.

**Examples**

```
mix1 = rfckt.mixer;  
mix1.NetworkData
```

```
ans =
```

```
Name: 'Network parameters'  
Type: 'S_PARAMETERS'  
Freq: [191x1 double]  
Data: [2x2x191 double]  
Z0: 50
```

# rfckt.mixer.NoiseData property

---

<b>Purpose</b>	Noise information
<b>Values</b>	Scalar noise figure in decibels, <code>rfdata.noise</code> object or <code>rfdata.nf</code> object
<b>Description</b>	A scalar value or object that stores noise data. The default is an <code>rfdata.noise</code> object whose values are taken from the 'default.s2p' data file.
<b>Examples</b>	<pre>mix1 = rfckt.mixer; mix1.NoiseData  ans =        Name: 'Spot noise data'       Freq: [9x1 double]       FMIN: [9x1 double]       GAMMAOPT: [9x1 double]       RN: [9x1 double]</pre>



# rfckt.mixer.NonlinearData property

---

<b>Purpose</b>	Nonlinearity information
<b>Values</b>	Scalar OIP3 in decibels relative to one milliwatt, <code>rfdata.power</code> object or <code>rfdata.ip3</code> object
<b>Description</b>	A scalar value or object that stores nonlinearity data. The default is an <code>Inf</code> .
<b>Examples</b>	<pre>mix1 = rfckt.mixer; mix1.NonlinearData  ans =      Inf</pre>

# rfckt.mixer.PhaseNoiseLevel property

---

**Purpose** Phase noise data

**Values** Vector

**Description** Vector specifying the phase noise levels, in dBc/Hz, that correspond to the frequency offset values specified by the `FreqOffset` property. This property is empty by default.

**Examples**

```
mix1 = rfckt.mixer;  
mix1.PhaseNoiseLevel = [-75, -110];
```

**Purpose**            Number of ports

**Values**            2

**Description**      A read-only integer that indicates the object has two ports.

**Examples**          `mix1 = rfckt.mixer;`  
                      `mix1.nPort`

`ans =`

`2`

# rfckt.parallel.AnalyzedResult property

---

**Purpose** Computed S-parameters, noise figure, OIP3, and group delay values

**Values** `rfdata.data` object

**Description** Handle to an `rfdata.data` object that contains the S-parameters, noise figure, OIP3, and group delay values computed over the specified frequency range using the `analyze` method. This property is empty by default.

The `analyze` method computes the S-parameters of the `AnalyzedResult` property using the data stored in the `Ckts` property as follows:

- 1 The `analyze` method first calculates the admittance matrix of the parallel connected network. It starts by converting each component network's parameters to an admittance matrix. The following figure shows a parallel connected network consisting of two 2-port networks, each represented by its admittance matrix,

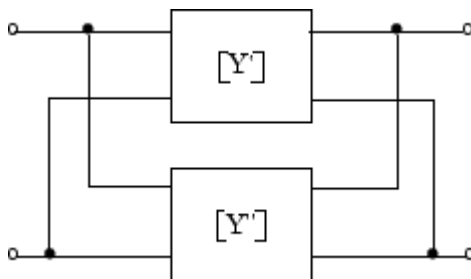

where

$$[Y'] = \begin{bmatrix} Y_{11}' & Y_{12}' \\ Y_{21}' & Y_{22}' \end{bmatrix}$$
$$[Y''] = \begin{bmatrix} Y_{11}'' & Y_{12}'' \\ Y_{21}'' & Y_{22}'' \end{bmatrix}$$

- The analyze method then calculates the admittance matrix for the parallel network by calculating the sum of the individual admittances. The following equation illustrates the calculations for two 2-port circuits.

$$[Y] = [Y'] + [Y''] = \begin{bmatrix} Y_{11}' + Y_{11}'' & Y_{12}' + Y_{12}'' \\ Y_{21}' + Y_{21}'' & Y_{22}' + Y_{22}'' \end{bmatrix}$$

- Finally, analyze converts the admittance matrix of the parallel network to S-parameters at the frequencies specified in the analyze input argument freq.

The analyze method uses the parallel S-parameters to calculate the group delay values at the frequencies specified in the analyze input argument freq, as described in the analyze reference page.

## Examples

```
tx1 = rfckt.txline;  
tx2 = rfckt.txline;  
ple1 = rfckt.parallel('Ckts',{tx1,tx2})  
analyze(ple1,[1e9:1e7:2e9]);  
ple1.AnalyzedResult
```

```
ans =
```

```
      Name: 'Data object'  
      Freq: [101x1 double]  
S_Parameters: [2x2x101 double]  
  GroupDelay: [101x1 double]  
         NF: [101x1 double]  
       OIP3: [101x1 double]  
         Z0: 50  
         ZS: 50  
         ZL: 50  
      IntpType: 'Linear'
```

# rfckt.parallel.Ckts property

---

**Purpose**            Circuit objects in network

**Values**            Cell

**Description**      Cell array containing handles to all circuit objects in the network. All circuits must be 2-port and linear. This property is empty by default.

**Examples**

```
tx1 = rfckt.txline;  
tx2 = rfckt.txline;  
ple1 = rfckt.parallel;  
ple1.Ckts = {tx1,tx2};  
ple1.Ckts  
  
ans =  
  
          [1x1 rfckt.txline] [1x1 rfckt.txline]
```

# rfckt.parallel.Name property

---

<b>Purpose</b>	Object name
<b>Values</b>	'Parallel Connected Network'
<b>Description</b>	Read-only string that contains the name of the object.
<b>Examples</b>	<pre>pl1 = rfckt.parallel; pl1.Name  ans =      Parallel Connected Network</pre>

# rfckt.parallel.nPort property

---

**Purpose**            Number of ports

**Values**            2

**Description**      A read-only integer that indicates the object has two ports.

**Examples**            `pl1 = rfckt.parallel;`  
                          `pl1.nPort`

`ans =`

`2`



# rfckt.parallelplate.AnalyzedResult property

**Purpose** Computed S-parameters, noise figure, OIP<sub>3</sub>, and group delay values

**Values** rfdata.data object

**Description** Handle to an rfdata.data object that contains the S-parameters, noise figure, OIP<sub>3</sub>, and group delay values computed over the specified frequency range using the analyze method. This property is empty by default.

The analyze method treats the parallel-plate line as a 2-port linear network and models the line as a transmission line with optional stubs. The analyze method computes the AnalyzedResult property of the line using the data stored in the rfckt.parallelplate object properties as follows:

- If you model the transmission line as a stubless line, the analyze method first calculates the ABCD-parameters at each frequency contained in the modeling frequencies vector. It then uses the abcd2s function to convert the ABCD-parameters to S-parameters.

The analyze method calculates the ABCD-parameters using the physical length of the transmission line,  $d$ , and the complex propagation constant,  $k$ , using the following equations:

$$A = \frac{e^{kd} + e^{-kd}}{2}$$
$$B = \frac{Z_0 * (e^{kd} - e^{-kd})}{2}$$
$$C = \frac{e^{kd} - e^{-kd}}{2 * Z_0}$$
$$D = \frac{e^{kd} + e^{-kd}}{2}$$

$Z_0$  and  $k$  are vectors whose elements correspond to the elements of  $f$ , the vector of frequencies specified in the analyze input argument

## rfckt.parallelplate.AnalyzedResult property

---

freq. Both can be expressed in terms of the resistance ( $R$ ), inductance ( $L$ ), conductance ( $G$ ), and capacitance ( $C$ ) per unit length (meters) as follows:

$$Z_0 = \sqrt{\frac{R + j2\pi fL}{G + j2\pi fC}}$$
$$k = k_r + jk_i = \sqrt{(R + j2\pi fL)(G + j2\pi fC)}$$

where

$$R = \frac{2}{w\sigma_{cond}\delta_{cond}}$$
$$L = \mu \frac{d}{w}$$
$$G = \omega\epsilon'' \frac{w}{d}$$
$$C = \epsilon \frac{w}{d}$$

In these equations:

- $w$  is the plate width.
- $d$  is the plate separation.
- $\sigma_{cond}$  is the conductivity in the conductor.
- $\mu$  is the permeability of the dielectric.
- $\epsilon$  is the permittivity of the dielectric.
- $\epsilon''$  is the imaginary part of  $\epsilon$ ,  $\epsilon'' = \epsilon_0\epsilon_r\tan \delta$ , where:
  - $\epsilon_0$  is the permittivity of free space.
  - $\epsilon_r$  is the EpsilonR property value.
  - $\tan \delta$  is the LossTangent property value.

- $\delta_{cond}$  is the skin depth of the conductor, which the block calculates as  $1/\sqrt{\pi f \mu \sigma_{cond}}$ .
- $f$  is a vector of modeling frequencies determined by the Output Port block.
- If you model the transmission line as a shunt or series stub, the `analyze` method first calculates the ABCD-parameters at the specified frequencies. It then uses the `abcd2s` function to convert the ABCD-parameters to S-parameters.

When you set the `StubMode` property to 'Shunt', the 2-port network consists of a stub transmission line that you can terminate with either a short circuit or an open circuit as shown in the following figure.

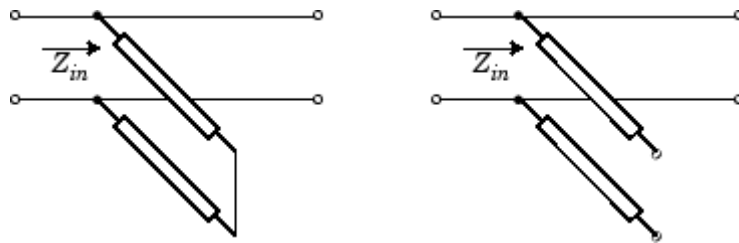

$Z_{in}$  is the input impedance of the shunt circuit. The ABCD-parameters for the shunt stub are calculated as:

$$A = 1$$

$$B = 0$$

$$C = 1 / Z_{in}$$

$$D = 1$$

When you set the `StubMode` property to 'Series', the 2-port network consists of a series transmission line that you can terminate with either a short circuit or an open circuit as shown in the following figure.

# rfckt.parallelplate.AnalyzedResult property

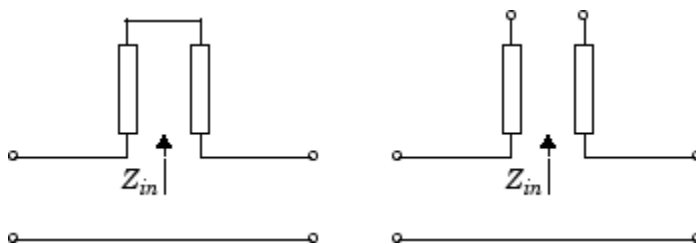

$Z_{in}$  is the input impedance of the series circuit. The ABCD-parameters for the series stub are calculated as:

$$A = 1$$

$$B = Z_{in}$$

$$C = 0$$

$$D = 1$$

The analyze method uses the S-parameters to calculate the group delay values at the frequencies specified in the analyze input argument freq, as described in the analyze reference page.

## Examples

```
tx1 = rfckt.parallelplate;  
analyze(tx1,[1e9,2e9,3e9]);  
tx1.AnalyzedResult
```

```
ans =
```

```
Name: 'Data object'  
Freq: [3x1 double]  
S_Parameters: [2x2x3 double]  
GroupDelay: [3x1 double]  
NF: [3x1 double]  
OIP3: [3x1 double]  
ZO: 50  
ZS: 50  
ZL: 50  
IntpType: 'Linear'
```

# rfckt.parallelplate.EpsilonR property

---

<b>Purpose</b>	Relative permittivity of dielectric
<b>Values</b>	Scalar
<b>Description</b>	The ratio of the permittivity of the dielectric, $\epsilon$ , to the permittivity of free space, $\epsilon_0$ . The default value is 2.3.
<b>Examples</b>	<pre>tx1=rfckt.parallelplate; tx1.EpsilonR=2.7;</pre>

## rfckt.parallelplate.LineLength property

---

<b>Purpose</b>	Parallel-plate line length
<b>Values</b>	Scalar
<b>Description</b>	The physical length of the parallel-plate transmission line in meters. The default is 0.01.
<b>Examples</b>	<pre>tx1 = rfckt.parallelplate; tx1.LineLength = 0.001;</pre>

# rfckt.parallelplate.LossTangent property

---

<b>Purpose</b>	Tangent of loss angle
<b>Values</b>	Scalar
<b>Description</b>	The loss angle tangent of the dielectric. The default is 0.
<b>Examples</b>	<pre>tx1=rfckt.parallelplate; tx1.LossTangent=0.002;</pre>

# rfckt.parallelplate.MuR property

---

**Purpose** Relative permeability of dielectric

**Values** Scalar

**Description** The ratio of the permeability of the dielectric,  $\mu$ , to the permeability of free space,  $\mu_0$ . The default value is 1.

**Examples** Change the relative permeability of the dielectric:

```
tx1=rfckt.parallelplate;  
tx1.MuR=0.8;
```



# rfckt.parallelplate.Name property

---

<b>Purpose</b>	Object name
<b>Values</b>	'Parallel-Plate Transmission Line'
<b>Description</b>	Read-only string that contains the name of the object.
<b>Examples</b>	<pre>tx1 = rfckt.parallelplate; tx1.Name  ans =      Parallel-Plate Transmission Line</pre>

## rfckt.parallelplate.Separation property

---

<b>Purpose</b>	Distance between plates
<b>Values</b>	Scalar
<b>Description</b>	Thickness, in meters, of the dielectric separating the plates. The default is $1.0e-3$ .
<b>Examples</b>	<pre>tx1=rfckt.parallelplate; tx1.Separation=0.8e-3;</pre>

# rfckt.parallelplate.SigmaCond property

---

<b>Purpose</b>	Conductor conductivity
<b>Values</b>	Scalar
<b>Description</b>	Conductivity, in Siemens per meter (S/m), of the conductor. The default is Inf.
<b>Examples</b>	<pre>tx1=rfckt.parallelplate; tx1.SigmaCond=5.81e7;</pre>

## rfckt.parallelplate.StubMode property

---

<b>Purpose</b>	Type of stub
<b>Values</b>	'NotAStub' (default), 'Series', or 'Shunt'
<b>Description</b>	String that specifies what type of stub, if any, to include in the transmission line model.
<b>Examples</b>	<pre>tx1 = rfckt.parallelplate; tx1.StubMode = 'Series';</pre>

# rfckt.parallelplate.Termination property

---

<b>Purpose</b>	Stub transmission line termination
<b>Values</b>	'NotApplicable' (default), 'Open', or 'Short'.
<b>Description</b>	String that specifies what type of termination to use for 'Shunt' and 'Series' stub modes. Termination is ignored if the line has no stub. Use 'NotApplicable' when StubMode is 'NotAStub'.
<b>Examples</b>	<pre>tx1 = rfckt.parallelplate; tx1.StubMode = 'Series'; tx1.Termination = 'Short';</pre>

## rfckt.parallelplate.Width property

---

**Purpose**            Transmission line width

**Values**            Scalar

**Description**       Physical width, in meters, of the parallel-plate transmission line. The default is .005..

**Examples**            `tx1=rfckt.parallelplate;`  
                          `tx1.Width=0.001;`

**Purpose**            Number of ports

**Values**            2

**Description**        A read-only integer that indicates the object has two ports.

**Examples**            `tx1 = rfckt.parallelplate;`  
                          `tx1.nPort`

`ans =`

`2`

# rfckt.passive.AnalyzedResult property

---

**Purpose** Computed S-parameters, noise figure, OIP3, and group delay values

**Values** `rfdata.data` object

**Description** Handle to an `rfdata.data` object that contains the S-parameters, noise figure, OIP3, and group delay values computed over the specified frequency range using the `analyze` method. The default is a 1-by-1 `rfdata.data` object that contains the S-parameters, noise figure, OIP3, and group delay values that result from analyzing the values stored in the `passive.s2p` file at the frequencies stored in this file.

The `analyze` method computes the `AnalyzedResult` property as follows:

The `analyze` method uses the data stored in the `'NetworkData'` property of the `rfckt.passive` object to calculate the S-parameter values of the passive component at the frequencies specified in `freq`. If the `'NetworkData'` property contains network Y- or Z-parameters, the `analyze` method first converts the parameters to S-parameters. Using the interpolation method you specify with the `'IntpType'` property, the `analyze` method interpolates the S-parameter values to determine their values at the specified frequencies.

Specifically, the `analyze` method orders the S-parameters according to the ascending order of their frequencies,  $f_n$ . It then interpolates the S-parameters, using the MATLAB `interp1` function. For example, the curve in the following diagram illustrates the result of interpolating the  $S_{11}$  parameters at five different frequencies.



# rfckt.passive.AnalyzedResult property

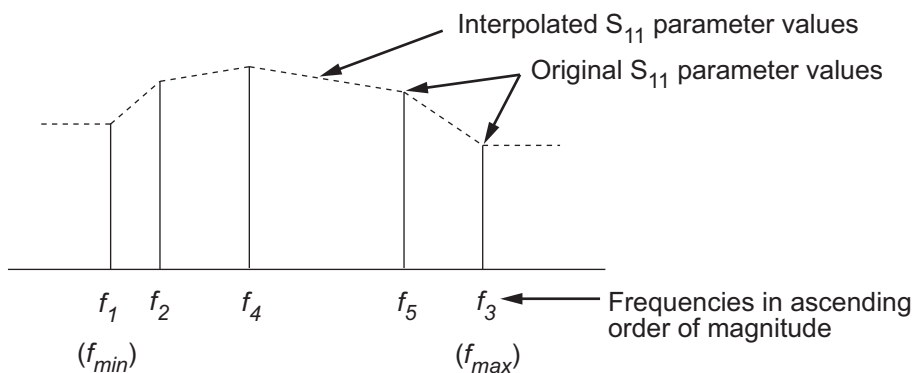

For more information, see “One-Dimensional Interpolation” and the `interp1` reference page in the MATLAB documentation.

As shown in the preceding diagram, the `analyze` method uses the parameter values at  $f_{min}$ , the minimum input frequency, for all frequencies smaller than  $f_{min}$ . It uses the parameters values at  $f_{max}$ , the maximum input frequency, for all frequencies greater than  $f_{max}$ . In both cases, the results may not be accurate, so you need to specify network parameter values over a range of frequencies that is wide enough to account for the component behavior.

The `analyze` method uses the S-parameters to calculate the group delay values at the frequencies specified in the `analyze` input argument `freq`, as described in the `analyze` reference page.

## Examples

```
pas = rfckt.passive;  
pas.AnalyzedResult  
  
ans =  
  
Name: 'Data object'  
Freq: [202x1 double]  
S_Parameters: [2x2x202 double]  
GroupDelay: [202x1 double]  
NF: [202x1 double]  
OIP3: [202x1 double]
```

## rfckt.passive.AnalyzedResult property

---

Z0: 50  
ZS: 50  
ZL: 50  
IntpType: 'Linear'

**Purpose** Interpolation method

**Values** 'Linear' (default), 'Spline', or 'Cubic'

**Description** The analyze method is flexible in that it does not require the frequencies of the specified S-parameters to match the requested analysis frequencies. If needed, analyze applies the interpolation and extrapolation method specified in the IntpType property to the specified data to create a new set of data at the requested analysis frequencies. The following table lists the available interpolation methods and describes each one.

Method	Description
Linear (default)	Linear interpolation
Spline	Cubic spline interpolation
Cubic	Piecewise cubic Hermite interpolation

## Examples

```
pas = rfckt.passive;  
pas.IntpType = 'cubic'
```

```
pas =
```

```
Name: 'Passive'  
nPort: 2  
AnalyzedResult: [1x1 rfdata.data]  
IntpType: 'Cubic'  
NetworkData: [1x1 rfdata.network]
```

# rfckt.passive.Name property

---

**Purpose** Object name

**Values** 'Passive'

**Description** Read-only string that contains the name of the object.

**Examples**

```
pas = rfckt.passive;  
pas.Name  
  
ans =  
  
Passive
```

# rfckt.passive.NetworkData property

---

**Purpose** Network parameter information

**Values** rfdata.network object

**Description** An rfdata.network object that stores network parameter data. The default network parameter values are taken from the 'passive.s2p' data file.

**Examples**

```
pas = rfckt.passive;  
pas.NetworkData
```

```
ans =
```

```
    Name: 'Network parameters'
```

```
    Type: 'S_PARAMETERS'
```

```
    Freq: [202x1 double]
```

```
    Data: [2x2x202 double]
```

```
    Z0: 50
```

# rfckt.passive.nPort property

---

**Purpose**            Number of ports

**Values**            2

**Description**      A read-only integer that indicates the object has two ports.

**Examples**            `pas = rfckt.passive;`  
                          `pas.nPort`

`ans =`

`2`

# rfckt.rlcgline.AnalyzedResult property

**Purpose** Computed S-parameters, noise figure, OIP3, and group delay values

**Values** rfdata.data object

**Description** Handle to an rfdata.data object that contains the S-parameters, noise figure, OIP3, and group delay values computed over the specified frequency range using the analyze method. This property is empty by default.

The analyze method treats the transmission line, which can be lossy or lossless, as a 2-port linear network. It uses the interpolation method you specify in the IntpType property to find the R, L, C, and G values at the frequencies you specify when you call analyze. Then, it calculates the characteristic impedance, Z0, phase velocity, PV, and loss using these interpolated values. It computes the AnalyzedResult property of a stub or as a stubless line using the data stored in the rfckt.rlcgline object properties as follows:

- If you model the transmission line as a stubless line, the analyze method first calculates the ABCD-parameters at each frequency contained in the modeling frequencies vector. It then uses the abcd2s function to convert the ABCD-parameters to S-parameters.

The analyze method calculates the ABCD-parameters using the physical length of the transmission line,  $d$ , and the complex propagation constant,  $k$ , using the following equations:

$$A = \frac{e^{kd} + e^{-kd}}{2}$$
$$B = \frac{Z_0 * (e^{kd} - e^{-kd})}{2}$$
$$C = \frac{e^{kd} - e^{-kd}}{2 * Z_0}$$
$$D = \frac{e^{kd} + e^{-kd}}{2}$$

## rfckt.rlcgline.AnalyzedResult property

$Z_0$  and  $k$  are vectors whose elements correspond to the elements of  $f$ , the vector of frequencies specified in the `analyze` input argument `freq`. Both can be expressed in terms of the resistance ( $R$ ), inductance ( $L$ ), conductance ( $G$ ), and capacitance ( $C$ ) per unit length (meters) as follows:

$$Z_0 = \sqrt{\frac{R + j2\pi fL}{G + j2\pi fC}}$$
$$k = k_r + jk_i = \sqrt{(R + j2\pi fL)(G + j2\pi fC)}$$

- If you model the transmission line as a shunt or series stub, the `analyze` method first calculates the ABCD-parameters at the specified frequencies. It then uses the `abcd2s` function to convert the ABCD-parameters to S-parameters.

When you set the `StubMode` property to 'Shunt', the 2-port network consists of a stub transmission line that you can terminate with either a short circuit or an open circuit as shown in the following figure.

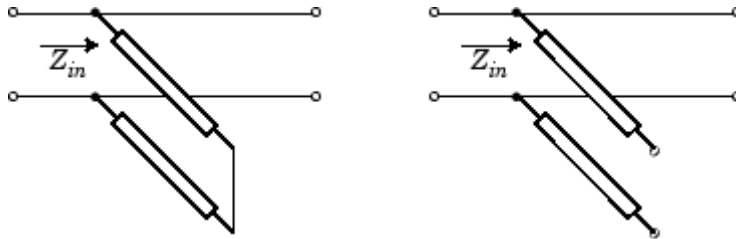

$Z_{in}$  is the input impedance of the shunt circuit. The ABCD-parameters for the shunt stub are calculated as:

$$A = 1$$
$$B = 0$$
$$C = 1 / Z_{in}$$
$$D = 1$$

When you set the `StubMode` property to 'Series', the 2-port network consists of a series transmission line that you can terminate with



# rfckt.rlcgline.AnalyzedResult property

either a short circuit or an open circuit as shown in the following figure.

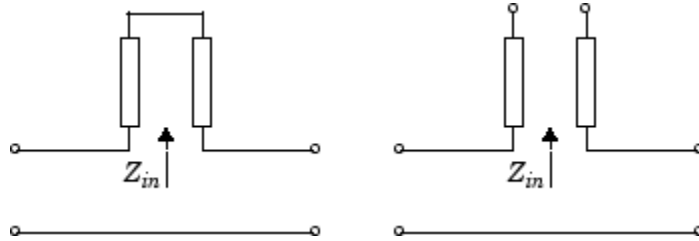

$Z_{in}$  is the input impedance of the series circuit. The ABCD-parameters for the series stub are calculated as:

$$\begin{aligned} A &= 1 \\ B &= Z_{in} \\ C &= 0 \\ D &= 1 \end{aligned}$$

The analyze method uses the S-parameters to calculate the group delay values at the frequencies specified in the analyze input argument freq, as described in the analyze reference page.

## Examples

```
tx1 = rfckt.rlcgline;  
analyze(tx1,[1e9,2e9,3e9]);  
tx1.AnalyzedResult
```

```
ans =
```

```
Name: 'Data object'  
Freq: [3x1 double]  
S_Parameters: [2x2x3 double]  
GroupDelay: [3x1 double]  
F: [3x1 double]  
OIP3: [3x1 double]  
Z0: 50
```

## rfckt.rlcgline.AnalyzedResult property

---

ZS: 50  
ZL: 50  
IntpType: 'Linear'

<b>Purpose</b>	Capacitance data
<b>Values</b>	Vector
<b>Description</b>	Capacitance values per length, in farads per meter, that correspond to the frequencies stored in the Freq property. All values must be nonnegative. The default is 0.
<b>Examples</b>	<pre>tx1=rfckt.rlcgline; tx1.C = [10.1 4.5 14.2]*1e-12;</pre>

## rfckt.rlcgline.Freq property

---

**Purpose** Frequency data

**Values** Vector

**Description** M-element vector of frequency values in hertz for the RLCG values. The values must be positive, and the order of the frequencies must correspond to the order of the RLCG values. The default is 1e9.

**Examples**

```
f = [2.08 2.10]*1.0e9;  
tx1 = rfckt.rlcgline;  
tx1.Freq = f;
```

<b>Purpose</b>	Conductance data
<b>Values</b>	Vector
<b>Description</b>	Conductances per length, in Siemens per meter, that correspond to the frequencies stored in the Freq property. All values must be nonnegative. The default is 0.
<b>Examples</b>	<pre>tx1=rfckt.rlcgline; tx1.G = [10.1 4.5 14.2]*1e-3;</pre>

# rfckt.rlcgline.IntpType property

---

**Purpose** Interpolation method

**Values** 'Linear' (default), 'Spline', or 'Cubic'

**Description** The analyze method is flexible in that it does not require the frequencies of the specified S-parameters to match the requested analysis frequencies. If needed, analyze applies the interpolation and extrapolation method specified in the IntpType property to the specified data to create a new set of data at the requested analysis frequencies. The following table lists the available interpolation methods and describes each one.

Method	Description
Linear (default)	Linear interpolation
Spline	Cubic spline interpolation
Cubic	Piecewise cubic Hermite interpolation

**Examples**

```
tx1 = rfckt.rlcgline;  
tx1.IntpType = 'cubic';
```

<b>Purpose</b>	Inductance data
<b>Values</b>	Vector
<b>Description</b>	Inductance values per length, in henries per meter, that correspond to the frequencies stored in the Freq property. All values must be nonnegative. The default is 0.
<b>Examples</b>	<pre>filter = rfckt.rlcgline; filter.L = [3.1 5.9 16.3]*1e-9;</pre>

## rfckt.rlcgline.LineLength property

---

<b>Purpose</b>	Transmission line length
<b>Values</b>	Scalar
<b>Description</b>	The physical length of the transmission line in meters. The default is 0.01.
<b>Examples</b>	<pre>tx1 = rfckt.rlcgline; tx1.LineLength = 0.001;</pre>



# rfckt.rlcgline.Name property

---

<b>Purpose</b>	Object name
<b>Values</b>	'RLCG Transmission Line'
<b>Description</b>	Read-only string that contains the name of the object.
<b>Examples</b>	<pre>tx1 = rfckt.rlcgline; tx1.Name  ans =        RLCG Transmission Line</pre>

## rfckt.rlcgline.R property

---

**Purpose** Resistance data

**Values** Vector

**Description** Resistance per length, in ohms per meter, that correspond to the frequencies stored in the `Freq` property. All values must be nonnegative. The default is 0.

**Examples**

```
filter = rfckt.rlcgline;  
filter.R = [3.1 5.9 16.3]*1e-3;
```

## rfckt.rlcgline.StubMode property

---

<b>Purpose</b>	Type of stub
<b>Values</b>	'NotAStub' (default), 'Series', or 'Shunt'
<b>Description</b>	String that specifies what type of stub, if any, to include in the transmission line model.
<b>Examples</b>	<pre>tx1 = rfckt.rlcgline; tx1.StubMode = 'Series';</pre>

# rfckt.rlcgline.Termination property

---

**Purpose** Stub transmission line termination

**Values** 'NotApplicable' (default), 'Open', or 'Short'.

**Description** String that specifies what type of termination to use for 'Shunt' and 'Series' stub modes. Termination is ignored if the line has no stub. Use 'NotApplicable' when StubMode is 'NotAStub'.

**Examples**

```
tx1 = rfckt.rlcgline;  
tx1.StubMode = 'Series';  
tx1.Termination = 'Short';
```

**Purpose**            Number of ports

**Values**            2

**Description**      A read-only integer that indicates the object has two ports.

**Examples**          `tx1 = rfckt.rlcgline;`  
                      `tx1.nPort`

`ans =`

`2`

# rfckt.series.AnalyzedResult property

---

**Purpose** Computed S-parameters, noise figure, OIP3, and group delay values

**Values** `rfdata.data` object

**Description** Handle to an `rfdata.data` object that contains the S-parameters, noise figure, OIP3, and group delay values computed over the specified frequency range using the `analyze` method. This property is empty by default.

The `analyze` method computes the S-parameters of the `AnalyzedResult` property using the data stored in the `Ckts` property as follows:

- 1 The `analyze` method first calculates the impedance matrix of the series connected network. It starts by converting each component network's parameters to an impedance matrix. The following figure shows a series connected network consisting of two 2-port networks, each represented by its impedance matrix,

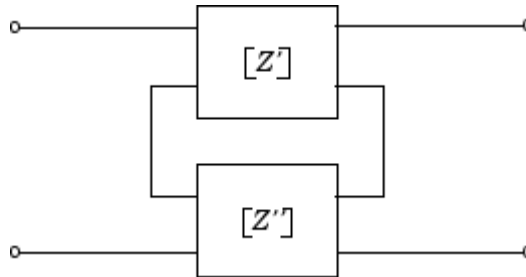

where

$$[Z'] = \begin{bmatrix} Z_{11}' & Z_{12}' \\ Z_{21}' & Z_{22}' \end{bmatrix}$$
$$[Z''] = \begin{bmatrix} Z_{11}'' & Z_{12}'' \\ Z_{21}'' & Z_{22}'' \end{bmatrix}$$

- The `analyze` method then calculates the impedance matrix for the series network by calculating the sum of the individual impedances. The following equation illustrates the calculations for two 2-port circuits.

$$[Z] = [Z'] + [Z''] = \begin{bmatrix} Z_{11}' + Z_{11}'' & Z_{12}' + Z_{12}'' \\ Z_{21}' + Z_{21}'' & Z_{22}' + Z_{22}'' \end{bmatrix}$$

- Finally, `analyze` converts the impedance matrix of the series network to S-parameters at the frequencies specified in the `analyze` input argument `freq`.

The `analyze` method uses the series S-parameters to calculate the group delay values at the frequencies specified in the `analyze` input argument `freq`, as described in the `analyze` reference page.

### Examples

```
tx1 = rfckt.txline;
tx2 = rfckt.txline;
ser = rfckt.series('Ckts',{tx1,tx2})
analyze(ser,[1e9:1e7:2e9]);
ser.AnalyzedResult
```

```
ans =
```

```
Name: 'Data object'
Freq: [101x1 double]
S_Parameters: [2x2x101 double]
GroupDelay: [101x1 double]
NF: [101x1 double]
OIP3: [101x1 double]
Z0: 50
ZS: 50
ZL: 50
IntpType: 'Linear'
```

# rfckt.series.Ckts property

---

**Purpose**            Circuit objects in network

**Values**            Cell

**Description**      Cell array containing handles to all circuit objects in the network. All circuits must be 2-port and linear. This property is empty by default.

**Examples**

```
tx1 = rfckt.txline;  
tx2 = rfckt.txline;  
ser = rfckt.series;  
ser.Ckts = {tx1,tx2};  
ser.Ckts
```

```
ans =
```

```
    [1x1 rfckt.txline] [1x1 rfckt.txline]
```



## rfckt.series.Name property

---

<b>Purpose</b>	Object name
<b>Values</b>	'Series Connected Network'
<b>Description</b>	Read-only string that contains the name of the object.
<b>Examples</b>	<pre>ser = rfckt.series; ser.Name  ans =      Series Connected Network</pre>

# rfckt.series.nPort property

---

**Purpose**            Number of ports

**Values**            2

**Description**      A read-only integer that indicates the object has two ports.

**Examples**

```
ser = rfckt.series;  
ser.nPort  
  
ans =  
  
      2
```

# rfckt.seriesrlc.AnalyzedResult property

**Purpose** Computed S-parameters, noise figure, OIP3, and group delay values

**Values** rfdata.data object

**Description** Handle to an rfdata.data object that contains the S-parameters, noise figure, OIP3, and group delay values computed over the specified frequency range using the analyze method. This property is empty by default.

The analyze method computes the S-parameters of the AnalyzedResult property using the data stored in the rfckt.seriesrlc object properties by first calculating the ABCD-parameters for the circuit, and then converting the ABCD-parameters to S-parameters using the abcd2s function. For this circuit,  $A = 1$ ,  $B = Z$ ,  $C = 0$ , and  $D = 1$ , where

$$Z = \frac{-LC\omega^2 + jRC\omega + 1}{jC\omega}$$

and  $\omega = 2\pi f$ .

The analyze method uses the S-parameters to calculate the group delay values at the frequencies specified in the analyze input argument freq, as described in the analyze reference page.

## Examples

```
rlc1 = rfckt.seriesrlc;  
analyze(rlc1,[1e9,2e9,3e9]);  
rlc1.AnalyzedResult
```

```
ans =
```

```
Name: 'Data object'  
Freq: [3x1 double]  
S_Parameters: [2x2x3 double]  
GroupDelay: [3x1 double]  
NF: [3x1 double]  
OIP3: [3x1 double]  
ZO: 50  
ZS: 50
```

# rfckt.seriesrlc.AnalyzedResult property

---

ZL: 50  
IntpType: 'Linear'

<b>Purpose</b>	Capacitance value
<b>Values</b>	Scalar
<b>Description</b>	Positive capacitance value in farads. The default is Inf.
<b>Examples</b>	<pre>rlc1=rfckt.seriesrlc; rlc1.C = 1e-12;</pre>

## rfckt.seriesrlc.L property

---

<b>Purpose</b>	Inductance value
<b>Values</b>	Scalar
<b>Description</b>	Positive inductance value in henries. The default is 0.
<b>Examples</b>	<pre>rlc1 = rfckt.seriesrlc; rlc1.L = 1e-9;</pre>

## rfckt.seriesrlc.Name property

---

<b>Purpose</b>	Object name
<b>Values</b>	'Series RLC'
<b>Description</b>	Read-only string that contains the name of the object.
<b>Examples</b>	<pre>rlc1 = rfckt.seriesrlc; rlc1.Name  ans =  Series RLC</pre>

## rfckt.seriesrlc.R property

---

<b>Purpose</b>	Resistance value
<b>Values</b>	Scalar
<b>Description</b>	Positive resistance in ohms. The default is 0.
<b>Examples</b>	<pre>rlc1 = rfckt.seriesrlc; rlc1.R = 10;</pre>



**Purpose** Number of ports

**Values** 2

**Description** A read-only integer that indicates the object has two ports.

**Examples**

```
filter = rfckt.seriesrlc;  
filter.nPort
```

```
ans =
```

```
2
```

# rfckt.shuntrlc.AnalyzedResult property

---

**Purpose** Computed S-parameters, noise figure, OIP3, and group delay values

**Values** rfdata.data object

**Description** Handle to an rfdata.data object that contains the S-parameters, noise figure, OIP3, and group delay values computed over the specified frequency range using the analyze method. This property is empty by default.

The analyze method computes the S-parameters of the AnalyzedResult property using the data stored in the rfckt.shuntrlc object properties by first calculating the ABCD-parameters for the circuit, and then converting the ABCD-parameters to S-parameters using the abcd2s function. For this circuit,  $A = 1$ ,  $B = 0$ ,  $C = Y$ , and  $D = 1$ , where

$$Y = \frac{-LC\omega^2 + j(L/R)\omega + 1}{jL\omega}$$

and  $\omega = 2\pi f$ .

The analyze method uses the S-parameters to calculate the group delay values at the frequencies specified in the analyze input argument freq, as described in the analyze reference page.

## Examples

```
rlc1 = rfckt.shuntrlc;  
analyze(rlc1,[1e9,2e9,3e9]);  
rlc1.AnalyzedResult
```

```
ans =
```

```
Name: 'Data object'  
Freq: [3x1 double]  
S_Parameters: [2x2x3 double]  
GroupDelay: [3x1 double]  
NF: [3x1 double]  
OIP3: [3x1 double]  
Z0: 50
```

# rfckt.shuntrlc.AnalyzedResult property

---

ZS: 50  
ZL: 50  
IntpType: 'Linear'

## rfckt.shuntrlc.C property

---

<b>Purpose</b>	Capacitance value
<b>Values</b>	Scalar
<b>Description</b>	Positive capacitance value in farads. The default is 0.
<b>Examples</b>	<pre>rlc1=rfckt.shuntrlc; rlc1.C = 1e-12;</pre>

<b>Purpose</b>	Inductance value
<b>Values</b>	Scalar
<b>Description</b>	Positive inductance value in henries. The default is Inf.
<b>Examples</b>	<pre>rlc1 = rfckt.shuntrlc; rlc1.L = 1e-9;</pre>

# rfckt.shuntrlc.Name property

---

**Purpose** Object name

**Values** 'Shunt RLC'

**Description** Read-only string that contains the name of the object.

**Examples**

```
rlc1 = rfckt.shuntrlc;  
rlc1.Name
```

```
ans =
```

```
Shunt RLC
```

<b>Purpose</b>	Resistance value
<b>Values</b>	Scalar
<b>Description</b>	Positive resistance in ohms. The default is Inf.
<b>Examples</b>	<pre>rlc1 = rfckt.shuntrlc; rlc1.R = 10;</pre>

# rfckt.shuntrlc.nPort property

---

**Purpose**            Number of ports

**Values**            2

**Description**      A read-only integer that indicates the object has two ports.

**Examples**            `filter = rfckt.shuntrlc;`  
                          `filter.nPort`

`ans =`

`2`



# rfckt.twowire.AnalyzedResult property

**Purpose** Computed S-parameters, noise figure, OIP3, and group delay values

**Values** rfdata.data object

**Description** Handle to an rfdata.data object that contains the S-parameters, noise figure, OIP3, and group delay values computed over the specified frequency range using the analyze method. This property is empty by default.

The analyze method treats the transmission line, which can be lossy or lossless, as a 2-port linear network. It computes the AnalyzedResult property of a stub or as a stubless line using the data stored in the rfckt.twowire object properties as follows:

- If you model the transmission line as a stubless line, the analyze method first calculates the ABCD-parameters at each frequency contained in the modeling frequencies vector. It then uses the abcd2s function to convert the ABCD-parameters to S-parameters.

The analyze method calculates the ABCD-parameters using the physical length of the transmission line,  $d$ , and the complex propagation constant,  $k$ , using the following equations:

$$A = \frac{e^{kd} + e^{-kd}}{2}$$
$$B = \frac{Z_0 * (e^{kd} - e^{-kd})}{2}$$
$$C = \frac{e^{kd} - e^{-kd}}{2 * Z_0}$$
$$D = \frac{e^{kd} + e^{-kd}}{2}$$

$Z_0$  and  $k$  are vectors whose elements correspond to the elements of  $f$ , the vector of frequencies specified in the analyze input argument freq. Both can be expressed in terms of the resistance ( $R$ ), inductance

## rfckt.twowire.AnalyzedResult property

---

( $L$ ), conductance ( $G$ ), and capacitance ( $C$ ) per unit length (meters) as follows:

$$Z_0 = \sqrt{\frac{R + j2\pi fL}{G + j2\pi fC}}$$
$$k = k_r + jk_i = \sqrt{(R + j2\pi fL)(G + j2\pi fC)}$$

where

$$R = \frac{1}{\pi a \sigma_{cond} \delta_{cond}}$$
$$L = \frac{\mu}{\pi} a \cosh\left(\frac{D}{2a}\right)$$
$$G = \frac{\pi \omega \varepsilon''}{a \cosh\left(\frac{D}{2a}\right)}$$
$$C = \frac{\pi \varepsilon}{a \cosh\left(\frac{D}{2a}\right)}$$

In these equations:

- $w$  is the plate width.
- $d$  is the plate separation.
- $\sigma_{cond}$  is the conductivity in the conductor.
- $\mu$  is the permeability of the dielectric.
- $\varepsilon$  is the permittivity of the dielectric.
- $\varepsilon''$  is the imaginary part of  $\varepsilon$ ,  $\varepsilon'' = \varepsilon_0 \varepsilon_r \tan \delta$ , where:
  - $\varepsilon_0$  is the permittivity of free space.
  - $\varepsilon_r$  is the EpsilonR property value.
  - $\tan \delta$  is the LossTangent property value.

- $\delta_{cond}$  is the skin depth of the conductor, which the block calculates as  $1/\sqrt{\pi f \mu \sigma_{cond}}$ .
- $f$  is a vector of modeling frequencies determined by the Output Port block.
- If you model the transmission line as a shunt or series stub, the analyze method first calculates the ABCD-parameters at the specified frequencies. It then uses the abcd2s function to convert the ABCD-parameters to S-parameters.

When you set the StubMode property to 'Shunt', the 2-port network consists of a stub transmission line that you can terminate with either a short circuit or an open circuit as shown in the following figure.

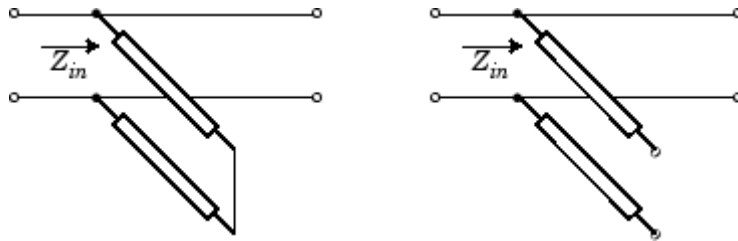

$Z_{in}$  is the input impedance of the shunt circuit. The ABCD-parameters for the shunt stub are calculated as:

$$A = 1$$

$$B = 0$$

$$C = 1 / Z_{in}$$

$$D = 1$$

When you set the StubMode property to 'Series', the 2-port network consists of a series transmission line that you can terminate with either a short circuit or an open circuit as shown in the following figure.

# rfckt.twowire.AnalyzedResult property

---

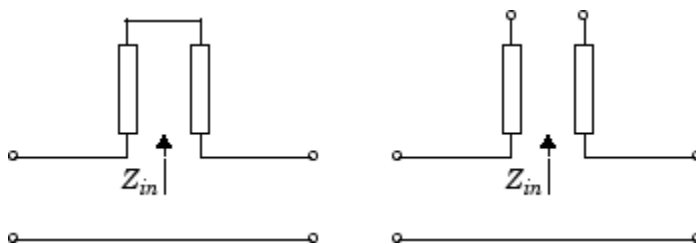

$Z_{in}$  is the input impedance of the series circuit. The ABCD-parameters for the series stub are calculated as:

$$A = 1$$

$$B = Z_{in}$$

$$C = 0$$

$$D = 1$$

The analyze method uses the S-parameters to calculate the group delay values at the frequencies specified in the analyze input argument freq, as described in the analyze reference page.

## Examples

```
tx1 = rfckt.twowire;  
analyze(tx1,[1e9,2e9,3e9]);  
tx1.AnalyzedResult
```

```
ans =
```

```
Name: 'Data object'  
Freq: [3x1 double]  
S_Parameters: [2x2x3 double]  
GroupDelay: [3x1 double]  
NF: [3x1 double]  
OIP3: [3x1 double]  
ZO: 50  
ZS: 50  
ZL: 50  
IntpType: 'Linear'
```

<b>Purpose</b>	Relative permittivity of dielectric
<b>Values</b>	Scalar
<b>Description</b>	The ratio of the permittivity of the dielectric, $\epsilon$ , to the permittivity of free space, $\epsilon_0$ . The default value is 2.3.
<b>Examples</b>	<pre>tx1=rfckt.twowire; tx1.EpsilonR=2.7;</pre>

# rfckt.twowire.LineLength property

---

**Purpose**            Transmission line length

**Values**            Scalar

**Description**      The physical length of the transmission line in meters. The default is 0.01.

**Examples**            `tx1 = rfckt.twowire;`  
                          `tx1.LineLength = 0.001;`

# rfckt.twowire.LossTangent property

---

<b>Purpose</b>	Tangent of loss angle
<b>Values</b>	Scalar
<b>Description</b>	The loss angle tangent of the dielectric. The default is 0.
<b>Examples</b>	<pre>tx1=rfckt.twowire; tx1.LossTangent=0.002;</pre>

# rfckt.twowire.MuR property

---

**Purpose** Relative permeability of dielectric

**Values** Scalar

**Description** The ratio of the permeability of the dielectric,  $\mu$ , to the permeability of free space,  $\mu_0$ . The default value is 1.

**Examples** Change the relative permeability of the dielectric:

```
tx1=rfckt.twowire;  
tx1.MuR=0.8;
```



## rfckt.twowire.Name property

---

<b>Purpose</b>	Object name
<b>Values</b>	'Two-Wire Transmission Line'
<b>Description</b>	Read-only string that contains the name of the object.
<b>Examples</b>	<pre>tx1 = rfckt.twowire; tx1.Name  ans =  Two-Wire Transmission Line</pre>

# rfckt.twowire.Radius property

---

<b>Purpose</b>	Wire radius
<b>Values</b>	Scalar
<b>Description</b>	The radius of the conducting wires, in meters. The default is $6.7e-4$ .
<b>Examples</b>	<pre>tx1=rfckt.twowire; tx1.Radius=0.0031;</pre>

# rfckt.twowire.Separation property

---

<b>Purpose</b>	Distance between wires
<b>Values</b>	Scalar
<b>Description</b>	Distance, in meters, separating the wire centers. The default is 0.0016.
<b>Examples</b>	<pre>tx1=rfckt.twowire; tx1.Separation=0.8e-3;</pre>

## rfckt.twowire.SigmaCond property

---

**Purpose** Conductor conductivity

**Values** Scalar

**Description** Conductivity, in Siemens per meter (S/m), of the conductor. The default is Inf.

**Examples**

```
tx1=rfckt.twowire;  
tx1.SigmaCond=5.81e7;
```

# rfckt.twowire.StubMode property

---

<b>Purpose</b>	Type of stub
<b>Values</b>	'NotAStub' (default), 'Series', or 'Shunt'
<b>Description</b>	String that specifies what type of stub, if any, to include in the transmission line model.
<b>Examples</b>	<pre>tx1 = rfckt.twowire; tx1.StubMode = 'Series';</pre>

# rfckt.twowire.Termination property

---

**Purpose** Stub transmission line termination

**Values** 'NotApplicable' (default), 'Open', or 'Short'.

**Description** String that specifies what type of termination to use for 'Shunt' and 'Series' stub modes. Termination is ignored if the line has no stub. Use 'NotApplicable' when StubMode is 'NotAStub'.

**Examples**

```
tx1 = rfckt.twowire;  
tx1.StubMode = 'Series';  
tx1.Termination = 'Short';
```

**Purpose**            Number of ports

**Values**            2

**Description**      A read-only integer that indicates the object has two ports.

**Examples**          `tx1 = rfckt.twowire;`  
                      `tx1.nPort`

`ans =`

`2`

# rfckt.txline.AnalyzedResult property

---

**Purpose** Computed S-parameters, noise figure, OIP3, and group delay values

**Values** `rfdata.data` object

**Description** Handle to an `rfdata.data` object that contains the S-parameters, noise figure, OIP3, and group delay values computed over the specified frequency range using the `analyze` method. This property is empty by default.

The `analyze` method treats the transmission line, which can be lossy or lossless, as a 2-port linear network. It computes the `AnalyzedResult` property of a stub or as a stubless line using the data stored in the `rfckt.txline` object properties as follows:

- If you model the transmission line as a stubless line, the `analyze` method first calculates the ABCD-parameters at each frequency contained in the modeling frequencies vector. It then uses the `abcd2s` function to convert the ABCD-parameters to S-parameters.

The `analyze` method calculates the ABCD-parameters using the physical length of the transmission line,  $d$ , and the complex propagation constant,  $k$ , using the following equations:

$$A = \frac{e^{kd} + e^{-kd}}{2}$$
$$B = \frac{Z_0 * (e^{kd} - e^{-kd})}{2}$$
$$C = \frac{e^{kd} - e^{-kd}}{2 * Z_0}$$
$$D = \frac{e^{kd} + e^{-kd}}{2}$$

$Z_0$  is the specified characteristic impedance.  $k$  is a vector whose elements correspond to the elements of the input vector `freq`. The `analyze` method calculates  $k$  from the specified properties as



$k = \alpha_a + i\beta$ , where  $\alpha_a$  is the attenuation coefficient and  $\beta$  is the wave number. The attenuation coefficient  $\alpha_a$  is related to the specified loss,  $\alpha$ , by

$$\alpha_a = -\ln(10^{\alpha/20})$$

The wave number  $\beta$  is related to the specified phase velocity,  $V_p$ , by

$$\beta = \frac{2\pi f}{V_p},$$

where  $f$  is the frequency range specified in the analyze input argument `freq`. The phase velocity  $V_p$  is derived from the `rfckt.txline` object properties. It is also known as the *wave propagation velocity*.

- If you model the transmission line as a shunt or series stub, the `analyze` method first calculates the ABCD-parameters at the specified frequencies. It then uses the `abcd2s` function to convert the ABCD-parameters to S-parameters.

When you set the `StubMode` property to 'Shunt', the 2-port network consists of a stub transmission line that you can terminate with either a short circuit or an open circuit as shown in the following figure.

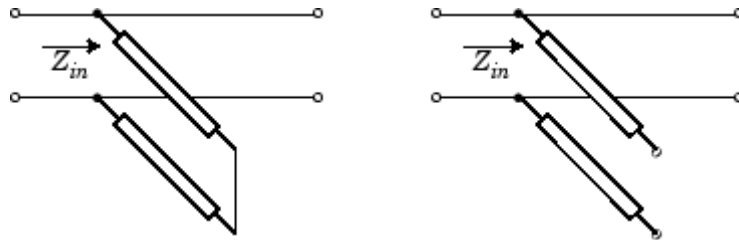

$Z_{in}$  is the input impedance of the shunt circuit. The ABCD-parameters for the shunt stub are calculated as:

# rfckt.txline.AnalyzedResult property

---

$$\begin{aligned}A &= 1 \\B &= 0 \\C &= 1 / Z_{in} \\D &= 1\end{aligned}$$

When you set the `StubMode` property to 'Series', the 2-port network consists of a series transmission line that you can terminate with either a short circuit or an open circuit as shown in the following figure.

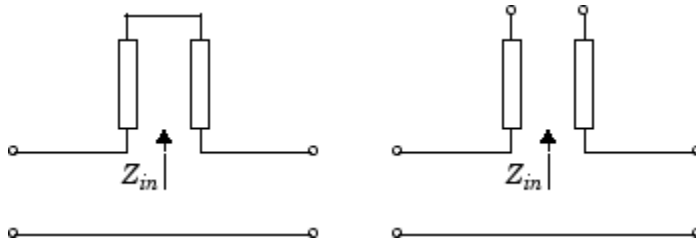

$Z_{in}$  is the input impedance of the series circuit. The ABCD-parameters for the series stub are calculated as:

$$\begin{aligned}A &= 1 \\B &= Z_{in} \\C &= 0 \\D &= 1\end{aligned}$$

The `analyze` method uses the S-parameters to calculate the group delay values at the frequencies specified in the `analyze` input argument `freq`, as described in the `analyze` reference page.

## Examples

```
tx1 = rfckt.txline;  
analyze(tx1,[1e9,2e9,3e9]);  
tx1.AnalyzedResult
```

```
ans =
```

## rfckt.txline.AnalyzedResult property

---

Name: 'Data object'  
Freq: [3x1 double]  
S\_Parameters: [2x2x3 double]  
GroupDelay: [3x1 double]  
NF: [3x1 double]  
OIP3: [3x1 double]  
Z0: 50  
ZS: 50  
ZL: 50  
IntpType: 'Linear'

# rfckt.txline.Freq property

---

**Purpose** Frequency data

**Values** Vector

**Description** M-element vector of frequency values in hertz for the loss and phase velocity values in the `Loss` and `PV` properties. The values must be positive, and the order of the frequencies must correspond to the order of the loss and phase velocity values. This property is empty by default.

**Examples**

```
f = [2.08 2.10]*1.0e9;  
tx1 = rfckt.txline;  
tx1.Freq = f;
```

**Purpose** Interpolation method

**Values** 'Linear' (default), 'Spline', or 'Cubic'

**Description** The analyze method is flexible in that it does not require the frequencies of the specified S-parameters to match the requested analysis frequencies. If needed, analyze applies the interpolation and extrapolation method specified in the IntpType property to the specified data to create a new set of data at the requested analysis frequencies. The following table lists the available interpolation methods and describes each one.

Method	Description
Linear (default)	Linear interpolation
Spline	Cubic spline interpolation
Cubic	Piecewise cubic Hermite interpolation

**Examples**

```
tx1 = rfckt.txline;  
tx1.IntpType = 'cubic';
```

# rfckt.txline.LineLength property

---

**Purpose**            Transmission line length

**Values**            Scalar

**Description**      The physical length of the transmission line in meters. The default is 0.01.

**Examples**            `tx1 = rfckt.txline;`  
                          `tx1.LineLength = 0.001;`

<b>Purpose</b>	Transmission line loss
<b>Values</b>	Vector
<b>Description</b>	M-element vector of line loss values, in decibels per meter, that correspond to the frequencies stored in the <code>Freq</code> property. Line loss is the reduction in strength of the signal as it travels over the transmission line, and must be nonnegative. The default is 0.
<b>Examples</b>	<pre>tx1 = rfckt.txline; tx1.Loss = [1.5 3.1]*1e-2;</pre>

# rfckt.txline.Name property

---

**Purpose** Object name

**Values** 'Transmission Line'

**Description** Read-only string that contains the name of the object.

**Examples** `tx1 = rfckt.txline;`  
`tx1.Name`

`ans =`

`Transmission Line`



**Purpose** Phase velocity

**Values** Vector

**Description** M-element vector of phase velocity values, in meters per second, that correspond to the frequencies stored in the `Freq` property. Propagation velocity of a uniform plane wave on the transmission line. The default is 299792458.

**Examples**

```
tx1 = rfckt.txline;  
tx1.PV = [1.5 3.1]*1e9;
```

# rfckt.txline.StubMode property

---

<b>Purpose</b>	Type of stub
<b>Values</b>	'NotAStub' (default), 'Series', or 'Shunt'
<b>Description</b>	String that specifies what type of stub, if any, to include in the transmission line model.
<b>Examples</b>	<pre>tx1 = rfckt.txline; tx1.StubMode = 'Series';</pre>

# rfckt.txline.Termination property

---

<b>Purpose</b>	Stub transmission line termination
<b>Values</b>	'NotApplicable' (default), 'Open', or 'Short'.
<b>Description</b>	String that specifies what type of termination to use for 'Shunt' and 'Series' stub modes. Termination is ignored if the line has no stub. Use 'NotApplicable' when StubMode is 'NotAStub'.
<b>Examples</b>	<pre>tx1 = rfckt.txline; tx1.StubMode = 'Series'; tx1.Termination = 'Short';</pre>

## rfckt.txline.Z0 property

---

**Purpose** Characteristic impedance

**Values** Vector

**Description** Vector of characteristic impedance values, in ohms, that correspond to the frequencies stored in the Freq property. The default is 50 ohms.

**Examples**

```
tx1 = rfckt.txline;  
tx1.Z0 = 75;
```

**Purpose**            Number of ports

**Values**            2

**Description**      A read-only integer that indicates the object has two ports.

**Examples**          `tx1 = rfckt.txline;`  
                      `tx1.nPort`

`ans =`

`2`

# rfdata.data.Freq property

---

**Purpose** Frequency data

**Values** Vector

**Description** M-element vector of frequency values in hertz for the S-parameters in the `S_Parameters` property. The values must be positive, and the order of the frequencies must correspond to the order of the S-parameters. This property is empty by default.

**Examples**

```
f = [2.08 2.10]*1.0e9;  
txdata = rfdata.data;  
txdata.Freq = f;
```

## rfddata.data.GroupDelay property

---

**Purpose** Group delay data

**Values** Vector

**Description** M-element vector of group delay values in seconds that the toolbox calculates at each frequency in the `Freq` property when you call the `analyze` method. This property is empty by default.

# rfddata.data.IntpType property

---

**Purpose** Interpolation method

**Values** 'Linear' (default), 'Spline', or 'Cubic'

**Description** The analyze method is flexible in that it does not require the frequencies of the specified S-parameters to match the requested analysis frequencies. If needed, analyze applies the interpolation and extrapolation method specified in the IntpType property to the specified data to create a new set of data at the requested analysis frequencies. The following table lists the available interpolation methods and describes each one.

Method	Description
Linear (default)	Linear interpolation
Spline	Cubic spline interpolation
Cubic	Piecewise cubic Hermite interpolation

## Examples

```
txdata = rfddata.data;  
txdata.IntpType = 'cubic'
```

```
txdata =  
  
    Name: 'Data object'  
    Freq: []  
    S_Parameters: []  
    GroupDelay: []  
    NF: 0  
    OIP3: Inf  
    ZO: 50  
    ZS: 50  
    ZL: 50  
    IntpType: 'Cubic'
```



**Purpose** Noise figure

**Values** Scalar

**Description** The amount of noise relative to a noise temperature of 290 degrees kelvin, in decibels. The default value of zero indicates a noiseless system.

**Examples**

```
txdata = rfdata.data;  
txdata.NF=3
```

```
txdata =
```

```
Name: 'Data object'  
Freq: []  
S_Parameters: []  
GroupDelay: []  
NF: 3  
OIP3: Inf  
Z0: 50  
ZS: 50  
ZL: 50  
IntpType: 'Linear'
```

# rfddata.data.Name property

---

<b>Purpose</b>	Object name
<b>Values</b>	'Data object'
<b>Description</b>	Read-only string that contains the name of the object.
<b>Examples</b>	<pre>txdata = rfddata.data; txdata.Name  ans =      Data object</pre>

<b>Purpose</b>	Output third-order intercept point
<b>Values</b>	Scalar
<b>Description</b>	Signal distortion in watts. This property represents the hypothetical output signal level at which the third-order tones would reach the same amplitude level as the desired input tones. The default is Inf.
<b>Examples</b>	<pre>txdata = rfdata.data; txdata.OIP3 = 30;</pre>

# rfddata.data.S\_Parameters property

---

**Purpose** S-parameter data

## Values

**Description** 2-by-2-by-M array of S-parameters of the circuit described by the `rfddata.data` object, where M is the number of frequencies at which the network parameters are specified. The values correspond to the frequencies stored in the `Freq` property. This property is empty by default.

## Examples

```
s_vec(:,:,1) = ...
    [-0.724725-0.481324i, -0.685727+1.782660i; ...
     0.000000+0.000000i, -0.074122-0.321568i];
s_vec(:,:,2) = ...
    [-0.731774-0.471453i, -0.655990+1.798041i; ...
     0.001399+0.000463i, -0.076091-0.319025i];
s_vec(:,:,3) = ...
    [-0.738760-0.461585i, -0.626185+1.813092i; ...
     0.002733+0.000887i, -0.077999-0.316488i];
txdata = rfddata.data;
txdata.S_Parameters = s_vec;
```

<b>Purpose</b>	Reference impedance
<b>Values</b>	Scalar
<b>Description</b>	Scalar reference impedance in ohms. The default is 50 ohms.
<b>Examples</b>	<pre>txdata = rfdata.data; txdata.Z0 = 75;</pre>

## rfdata.data.ZL property

---

<b>Purpose</b>	Load impedance
<b>Values</b>	Scalar
<b>Description</b>	Scalar load impedance in ohms. The default is 50 ohms.
<b>Examples</b>	<pre>txdata = rfdata.data; txdata.ZL = 75;</pre>

<b>Purpose</b>	Source impedance
<b>Values</b>	Scalar
<b>Description</b>	Scalar source impedance in ohms. The default is 50 ohms.
<b>Examples</b>	<pre>txdata = rfddata.data; txdata.ZS = 75;</pre>

## rfddata.ip3.Data property

---

**Purpose** Third-order intercept values

**Values** Vector

**Description** M-element vector of IP3 data, in watts, that corresponds to the frequencies stored in the Freq property. The default is Inf.

**Examples**

```
ip3_vec = [-5.2 7.1];  
ip3data = rfddata.ip3;  
ip3data.Data = ip3_vec;
```



**Purpose** Frequency data

**Values** Vector

**Description** M-element vector of frequency values in hertz for the IP3 data in the Data property. The values must be positive, and the order of the frequencies must correspond to the order of the IP3 values. This property is empty by default.

**Examples**

```
f = [2.08 2.10]*1.0e9;  
ip3data = rfdata.ip3;  
ip3data.Freq = f;
```

## rfdata.ip3.Name property

---

<b>Purpose</b>	Object name
<b>Values</b>	'3rd order intercept'
<b>Description</b>	Read-only string that contains the name of the object.
<b>Examples</b>	<pre>ip3data = rfdata.ip3; ip3data.Name  ans =      3rd order intercept</pre>

<b>Purpose</b>	Power reference type
<b>Values</b>	'OIP3' (default) or 'IIP3'
<b>Description</b>	String that indicates whether the specified IP3 data is output or input IP3.
<b>Examples</b>	<pre>ip3data = rfdata.ip3; ip3data.Type  ans =      OIP3</pre>

# rfdata.mixerspurs.Data property

---

**Purpose** Mixer spur power values

**Values** Matrix

**Description** Matrix of values, in decibels, by which the mixer spur power is less than the power at the fundamental output frequency. Values must be between 0 and 99. This property is empty by default.

**Examples**

```
spurs = rfdata.mixerspurs...
        ('Data',[2 5 3; 1 0 99; 10 99 99],...
        'PinRef',3,'PLORef',5)
spurs.data

ans =

     2     5     3
     1     0    99
    10    99    99
```

## rfdata.mixerspur.Name property

---

<b>Purpose</b>	Object name
<b>Values</b>	'Intermodulation table'
<b>Description</b>	Read-only string that contains the name of the object.
<b>Examples</b>	<pre>spurdata = rfdata.mixerspur; spurdata.Name  ans =      Intermodulation table</pre>

# rfddata.mixerspур.PLORef property

---

**Purpose** Reference local oscillator power

**Values** Scalar

**Description** Scalar local oscillator power reference, in decibels relative to one milliwatt. The default is 0.

**Examples**

```
spurs = rfddata.mixerspур...  
        ('Data',[2 5 3; 1 0 99; 10 99 99],  
         'PinRef',3,'PLORef',5)  
spurs.PLORef  
  
ans =  
  
5
```

**Purpose** Reference input power

**Values** Scalar

**Description** Scalar input power reference, in decibels relative to one milliwatt. The default is 0.

**Examples**

```
spurs = rfddata.mixerspurs...
        ('Data',[2 5 3; 1 0 99; 10 99 99],...
         'PinRef',3,'PLORef',5)
spurs.PinRef

ans =

     3
```

# rfdata.network.Data property

---

**Purpose** Network parameter data

**Values** Array

**Description** 2-by-2-by-M array of network parameters, where M is the number of frequencies at which the network parameters are specified. The values correspond to the frequencies stored in the `Freq` property. This property is empty by default.

**Examples**

```
y(:,:,1) = [-.0090-.0104i, .0013+.0018i; ...  
            -.2947+.2961i, .0252+.0075i];  
y(:,:,2) = [-.0086-.0047i, .0014+.0019i; ...  
            -.3047+.3083i, .0251+.0086i];  
y(:,:,3) = [-.0051+.0130i, .0017+.0020i; ...  
            -.3335+.3861i, .0282+.0110i];
```

```
netdata = rfdata.network;  
netdata.Data=y;
```



**Purpose** Frequency data

**Values** Vector

**Description** M-element vector of frequency values in hertz for the network parameters in the Data property. The values must be positive, and the order of the frequencies must correspond to the order of the network parameters. This property is empty by default.

**Examples**

```
f = [2.08 2.10]*1.0e9;  
netdata = rfdata.network;  
netdata.Freq=f;
```

# rfdata.network.Name property

---

<b>Purpose</b>	Object name
<b>Values</b>	'Network parameters'
<b>Description</b>	Read-only string that contains the name of the object.
<b>Examples</b>	<pre>netdata=rfdata.network; netdata.Name  ans =      Network parameters</pre>

## rfdata.network.Type property

---

<b>Purpose</b>	Type of network parameters.
<b>Values</b>	'S', 'Y', 'Z', 'ABCD', 'H', 'G', or 'T'
<b>Description</b>	String that indicates whether the rfdata.network object .
<b>Examples</b>	<pre>netdata=rfdata.network; netdata.Type='Y';</pre>

## rfdata.network.Z0 property

---

<b>Purpose</b>	Reference impedance
<b>Values</b>	Scalar
<b>Description</b>	Scalar reference impedance in ohms. This property is only available when the Type property is set to 'S'. The default is 50 ohms.
<b>Examples</b>	<pre>netdata=rfdata.network; netdata.z0=75;</pre>

**Purpose** Noise figure values

**Values** Vector

**Description** M-element vector of noise figure data, in dB, that corresponds to the frequencies stored in the Freq property. The default is 0.

**Examples**

```
nf_vec = [1.2 3.1];  
nfdata = rfddata.nf;  
nfdata.Data = nf_vec;
```

# rfdata.nf.Freq property

---

**Purpose** Frequency data

**Values** Vector

**Description** M-element vector of frequency values in hertz for the noise figure data in the Data property. The values must be positive, and the order of the frequencies must correspond to the order of the noise figure values. This property is empty by default.

**Examples**

```
f = [2.08 2.10]*1.0e9;  
nfdata = rfdata.nf;  
nfdata.Freq = f;
```

<b>Purpose</b>	Object name
<b>Values</b>	'Noise figure'
<b>Description</b>	Read-only string that contains the name of the object.
<b>Examples</b>	<pre>nfddata = rfdata.nf; nfddata.Name  ans =      Noise figure</pre>

## rfdata.noise.FMIN property

---

**Purpose** Minimum noise figure data

**Values** Vector

**Description** M-element vector of minimum noise figure values, in decibels, that correspond to the frequencies stored in the Freq property. The default is 1.

**Examples**

```
fmin = [12.08 13.40];  
noisedata = rfdata.noise;  
noisedata.FMIN = fmin;
```



**Purpose** Frequency data

**Values** Vector

**Description** M-element vector of frequency values in hertz for the spot noise data in the FMIN, GAMMAOPT, and RN properties. The values must be positive, and the order of the frequencies must correspond to the order of the spot noise values. This property is empty by default.

**Examples**

```
f = [2.08 2.10]*1.0e9;  
noisedata = rfdata.noise;  
noisedata.Freq = f;
```

# rfdata.noise.GAMMAOPT property

---

<b>Purpose</b>	Optimum source reflection coefficients
<b>Values</b>	Vector
<b>Description</b>	M-element vector of optimum source reflection coefficients that correspond to the frequencies stored in the Freq property. The default is 1.
<b>Examples</b>	<pre>gopt = [0.2484-1.2102j 1.0999-0.9295j]; noisedata = rfdata.noise; noisedata.GAMMAOPT = gopt;</pre>

<b>Purpose</b>	Object name
<b>Values</b>	'Spot noise data'
<b>Description</b>	Read-only string that contains the name of the object.
<b>Examples</b>	<pre>noisedata = rfdata.noise; noisedata.Name  ans =      Spot noise data</pre>

# rfdata.noise.RN property

---

**Purpose** Equivalent normalized noise resistance data

**Values** Vector

**Description** M-element vector of equivalent normalized noise resistance values that correspond to the frequencies stored in the Freq property. The default is 1.

**Examples**

```
rn = [0.26 0.45];  
noisedata = rfdata.noise;  
noisedata.RN = rn;
```

**Purpose** Frequency data

**Values** Vector

**Description** M-element vector of frequency values in hertz for the power data in the Phase, Pin, and Pout properties. The values must be positive, and the order of the frequencies must correspond to the order of the phase and power values. This property is empty by default.

**Examples**

```
f = [2.08 2.10]*1.0e9;  
powerdata = rfddata.power;  
powerdata.Freq = f;
```

# rfdata.power.Name property

---

**Purpose** Object name

**Values** 'Power data'

**Description** Read-only string that contains the name of the object.

**Examples**

```
powerdata = rfdata.power;  
powerdata.Name
```

```
ans =
```

```
Power data
```

<b>Purpose</b>	Phase shift data
<b>Values</b>	Cell
<b>Description</b>	M-element cell of phase shift values, in degrees, where each element corresponds to a frequency stored in the <code>Freq</code> property. The values within each element correspond to the input power values stored in the <code>Pin</code> property. The default is 1.
<b>Examples</b>	<pre>phase = {[27.1 35.3],[15.4 19.3 21.1]}; powerdata = rfdata.power; powerdata.Phase = phase;</pre>

# rfdata.power.Pin property

---

**Purpose** Input power data

**Values** Cell

**Description** M-element cell of input power values, in watts, where each element corresponds to a frequency stored in the `Freq` property. For example,

```
Pin = {[A]; [B]; [C]};
```

where A, B, and C are column vectors that contain the `Pin` values at the first three frequencies stored in the `Freq` property. The default is 1.

**Examples**

```
pin = {[0.001 0.002],[0.001 0.005 0.01]};  
powerdata = rfdata.power;  
powerdata.Pin = pin;
```



**Purpose** Output power data

**Values** Cell

**Description** M-element cell of output power values, in watts, where each element corresponds to a frequency stored in the `Freq` property. The values within each element correspond to the input power values stored in the `Pin` property. The default is 1.

**Examples**

```
pout = {[0.0025 0.0031],[0.0025 0.0028 0.0028]};  
powerdata = rfdata.power;  
powerdata.Pout = pout;
```

# rfmodel.rational.A property

---

**Purpose** Poles of rational function

**Values** Vector

**Description** Complex vector containing poles of the rational function in radians per second. Its length, shown in as n, must be equal to the length of the vector you provide for 'C'. n is the number of poles in the rational function model. This property is empty by default.

**Examples**

```
rat = rfmodel.rational;  
rat.A = [-0.0532 + 1.3166i; -0.0532 - 1.3166i]*1e10;
```

<b>Purpose</b>	Residues of rational function
<b>Values</b>	Vector
<b>Description</b>	Complex vector containing residues of the rational function in radians per second. Its length, shown in as n, must be equal to the length of the vector you provide for 'A'. n is the number of residues in the rational function model. This property is empty by default.
<b>Examples</b>	<pre>rat = rfmodel.rational; rat.C = [4.4896 - 4.5025i; 4.4896 + 4.5025i]*1e9;</pre>

## rfmodel.rational.D property

---

<b>Purpose</b>	Frequency response offset
<b>Values</b>	Scalar
<b>Description</b>	Scalar value specifying the constant offset in the frequency response of the rational function. The default is 0.
<b>Examples</b>	<pre>rat = rfmodel.rational; rat.D = 1e-3;</pre>

## rfmodel.rational.Delay property

---

**Purpose** Frequency response time delay

**Values** Scalar

**Description** Scalar value specifying the time delay, in seconds, in the frequency response of the rational function. The default is 0.

**Examples**

```
rat = rfmodel.rational;  
rat.Delay = 1e-9;
```

## rfmodel.rational.Name property

---

<b>Purpose</b>	Object name
<b>Values</b>	'Rational Function'
<b>Description</b>	Read-only string that contains the name of the object.
<b>Examples</b>	<pre>rat = rfmodel.rational; rat.Name  ans =      Rational Function</pre>

# Method Reference

---

Analysis (p. 8-2)	Calculate parameters of circuit objects, model objects, and networks
Plots and Charts (p. 8-3)	Display circuit object parameters
Parameters and Formats (p. 8-5)	List available parameters and formats for plots
Operating Conditions (p. 8-6)	Set or display operating condition information
Data I/O (p. 8-7)	Read or write data to or from circuit or data objects
Data Access and Restoration (p. 8-8)	Get object data in standard form or revert to original data

## Analysis

addMixer	Add mixer to multiband transmitter or receiver for IF planning analysis
analyze	Analyze circuit object in frequency domain
analyze	Analyze circuit object in frequency domain
freqresp	Frequency response of model object
freqresp	frequency response of model object
getSpurData	Find spurs in multiband transmitter or receiver frequency space
getSpurFreeZoneData	Find spur-free zones in multiband transmitter or receiver frequency space
ispassive	Check passivity of model object
ispassive	Check passivity of scalar model object
report	Summarize mixer configurations and spur-free-zone information for a multiband transmitter or receiver
show	Produce a spur graph for a multiband transmitter or receiver
stepresp	response of model object
stepresp	Step-signal response of model object
timeresp	ime response for model object
timeresp	Time response for model object



## Plots and Charts

circle	Draw circles on Smith chart
circle	Draw circles on Smith chart
loglog	Plot specified circuit object parameters using log-log scale
loglog	Plot specified circuit object parameters using log-log scale
plot	Plot specified circuit object parameters on X-Y plane
plot	Plot specified circuit object parameters on X-Y plane
plotty	Plot specified object parameters with <i>y</i> -axes on both left and right sides
plotty	Plot specified object parameters with <i>y</i> -axes on both left and right sides
polar	Plot specified circuit object parameters on polar coordinates
polar	Plot specified circuit object parameters on polar coordinates
semilogx	Plot specified circuit object parameters using log scale for <i>x</i> -axis
semilogx	Plot specified circuit object parameters using log scale for <i>x</i> -axis
semilogy	Plot specified circuit object parameters using log scale for <i>x</i> -axis
semilogy	Plot specified circuit object parameters using log scale for <i>x</i> -axis
smith	Plot specified circuit object parameters on Smith chart

smith	Plot specified circuit object parameters on Smith chart
table	Display specified RF object parameters in Variable Editor

## Parameters and Formats

listformat	List valid formats for specified circuit object parameter
listformat	List valid formats for specified circuit object parameter
listparam	List valid parameters for specified circuit object
listparam	List valid parameters for specified circuit object

## **Operating Conditions**

getop

Display operating conditions

getop

Display operating conditions

setop

Set operating conditions

setop

Set operating conditions

## Data I/O

read	Read RF data from file to new or existing circuit or data object
read	Read RF data from file to new or existing circuit or data object
write	Write RF data from circuit or data object to file
write	Write RF data from circuit or data object to file
writewa	Write Verilog-A description of RF model object
writewa	Write Verilog-A description of RF model object

## Data Access and Restoration

calculate	Calculate specified parameters for circuit object
calculate	Calculate specified parameters for circuit object
extract	Extract array of network parameters from data object
extract	Extract array of network parameters from data object
getz0	Characteristic impedance of transmission line object
getz0	Characteristic impedance of transmission line object
restore	Restore data to original frequencies
restore	Restore data to original frequencies

# Methods — Alphabetical List

---

# addMixer

---

**Purpose** Add mixer to multiband transmitter or receiver for IF planning analysis

**Syntax** `addMixer(hif,imt,rfbw,rfcf,injection,newIFBW)`

**Description** `addMixer(hif,imt,rfbw,rfcf,injection,newIFBW)` adds a mixer to a multiband transmitter or receiver object `hif` as part of an intermediate-frequency (IF) planning analysis workflow.

## Input Arguments

**hif**  
Specify the handle of the OpenIF object.

**imt**  
Provide the intermodulation table (IMT) for the mixer as a matrix of real numbers. Each entry in the intermodulation table is a number between 0 and 99. The matrix must be 2-by-2 or larger, and `imt(2,2)` must equal 0.

**rfcf**  
Specify the RF center frequency of the mixer in Hz.

**rfbw**  
Specify the RF bandwidth of the mixer in Hz.

**injection**  
Specify the mixer type. The available values for `injection` change depending on the setting of `hif.IFLocation`.

When `hif.IFLocation` is 'MixerOutput', the available values for `injection` are as follows.

- 'low' — The LO frequency is less than the RF (low-side injection).
- 'high' — The LO frequency is greater than the RF (high-side injection).



When `hif.IFLocation` is 'MixerInput', the available values for injection are as follows.

- 'sum' — The RF signal is the sum of the LO frequency and the IF.
- 'diff' — The RF signal is the difference between the LO frequency and the IF.

### **newIFBW**

Specify the IF bandwidth in Hz after mixing. Use this argument if the IF bandwidth before mixing (defined by the `hif.IFBW` property) is different from the bandwidth after mixing.

### **Examples**

- The `OpenIF` class reference page contains an example that shows how to find the spur-free zones of a multiband receiver with three mixers.
- The example `Finding Free IF Bandwidths` shows how to use information from a spur graph to design a multiband receiver with spur-free zones.

### **See Also**

`getSpurData` | `getSpurFreeZoneData` | `report` | `show` | `OpenIF`

# analyze

---

## Purpose

Analyze circuit object in frequency domain

## Syntax

```
analyze(h, freq)
analyze(h, freq, z1, zs, zo, aperture)
analyze(h, freq, 'condition1', value1, ..., 'conditionm', valuem)
```

## Description

`analyze(h, freq)` calculates the following circuit data at the specified frequency values:

- Circuit network parameters
- Noise figure
- Output third-order intercept point
- Power data
- Phase noise
- Voltage standing-wave ratio
- Power gain
- Group delay
- Reflection coefficients
- Stability data
- Transfer function

`h` is the handle of the circuit object to be analyzed. `freq` is a vector of frequencies, specified in hertz, at which to analyze the circuit.  $OIP_3$  is always infinite for passive circuits.

`analyze(h, freq, z1, zs, zo, aperture)` calculates the circuit data at the specified frequency values. The arguments `z1`, `zs`, `zo`, and `aperture` are optional. `z1`, `zs`, and `zo` represent the circuit load, circuit source, and reference impedances of the S-parameters, respectively. The default value of all these arguments is 50 ohms.

---

**Note** When you specify impedance values, the `analyze` method changes the object's values to match your specification.

---

The `aperture` argument determines the two frequency points that the `analyze` method uses to compute the group delay for each frequency in `freq`. `aperture` can be a positive scalar or a vector of the same length of as `freq`.

---

**Note** For `rfckt.datafile`, `rfckt.passive`, `rfckt.amplifier`, and `rfckt.mixer` objects that contain measured S-parameter data, the `analyze` method uses the two nearest measurement points to compute the group delay, regardless of the value of `aperture`.

---

Group delay  $\tau_g$  at each frequency point  $f$  is the negative slope of the phase angle of  $S_{21}$  with respect to  $f$ :

$$\tau_g(f) = -\frac{\Delta\phi}{\Delta\omega} = -\frac{\arg(S_{21}(f_+)) - \arg(S_{21}(f_-))}{2\pi(f_+ - f_-)}$$

where:

- $f_+$  is:
  - $f(1 + \text{aperture}/2)$  for `aperture` < 1.
  - $f + \text{aperture}/2$  for `aperture` ≥ 1.
 If  $f$  is the maximum value of `freq`, then  $f_+ = f$ .
- $f_-$  is:
  - $f(1 - \text{aperture}/2)$  for `aperture` < 1.
  - $f - \text{aperture}/2$  for `aperture` ≥ 1.
 If  $f$  is the minimum value of `freq`, then  $f_- = f$ .

By default, `analyze` calculates the group delay in nanoseconds.

The value of `aperture` affects the accuracy of the computed group delay. If `aperture` is too large, the slope estimate may be not accurate. If `aperture` is too small, the computer numerical error may affect the accuracy of the group delay result.

`analyze(h,freq,'condition1',value1,...,'conditionm',valuem)` calculates the circuit data at the specified frequency values and operating conditions for the object `h`. The inputs `'condition1',value1,...,'conditionm',valuem` are the condition/value pairs at which to analyze the object. Use this syntax for `rfckt.amplifier`, `rfckt.mixer`, and `rfdata.data` objects where the condition/value pairs are operating conditions from a `.p2d` or `.s2d` file.

---

**Note** When you specify condition/value pairs, the `analyze` method changes the object's values to match your specification.

---

When you analyze a network that contains several objects, RF Toolbox software does not issue an error or warning if the specified conditions cannot be applied to all objects. For some networks, because there is no error or warning, you can call the `analyze` method once to apply the same set of operating conditions to any objects where operating conditions are applicable. However, you may want to analyze a network that contains one or more of the following:

- Several objects with different sets of operating conditions.
- Several objects with the same set of operating conditions that are configured differently.

To analyze such a network, you should use the `setop` method to configure the operating conditions of each individual object before analyzing the network.

## Analysis of Circuit Objects

For most circuit objects, the `AnalyzedResult` property is empty until the `analyze` method is applied to the circuit object. However, the following four circuit objects are the exception to this rule:

- `rfckt.datafile` — By default, the `AnalyzedResult` property of `rfckt.datafile` objects contains the S-parameter, noise figure, and group delay values that are calculated over the network parameter frequencies in the `passive.s2p` data file. OIP3 is  $\infty$  by default because the data in `passive.s2p` is passive.
- `rfckt.passive` — By default, the `AnalyzedResult` property of `rfckt.passive` objects contains the S-parameter, noise figure, and group delay values that are the result of analyzing the values stored in the `passive.s2p` file at the frequencies stored in this file. These frequency values are also stored in the `NetworkData` property. OIP3 is always  $\infty$  for `rfckt.passive` objects because the data is passive.
- `rfckt.amplifier` — By default, the `AnalyzedResult` property of `rfckt.amplifier` objects contains the S-parameter, noise figure, OIP3, and group delay values that result from analyzing the values stored in the `default.amp` file at the frequencies stored in this file. These frequency values are also stored in the `NetworkData` property.
- `rfckt.mixer` — By default, the `AnalyzedResult` property of `rfckt.mixer` objects contains the S-parameter, noise figure, OIP3, and group delay values that result from analyzing the values stored in the `default.s2p` file at the frequencies stored in this file. These frequency values are also stored in the `NetworkData` property.

For a detailed explanation of how the `analyze` method calculates the network parameters, noise figure values, and OIP3 values for a particular object, see the `AnalyzedResult` property on the reference page for that object.

## References

<http://www.microwaves101.com/encyclopedia/groupdelaymeasurements.cfm>

## See Also

`calculate` | `extract` | `getz0` | `listformat` | `listparam` | `loglog` | `plot` | `plotyy` | `polar` | `semilogx` | `semilogy` | `smith` | `read` | `restore` | `write`

# calculate

---

## Purpose

Calculate specified parameters for circuit object

## Syntax

```
[data,params,freq] = calculate(h,'parameter1',...,'parameterN',  
    'format')  
[ydata,params,xdata] = calculate(h,'parameter1',...,  
    'parameterN', 'format',xparameter,xformat, 'condition1',  
    value1,...,'conditionM',valuem, 'freq',freq,'pin',pin)
```

## Description

[data,params,freq] = calculate(h,'parameter1',...,'parameterN', 'format') calculates the specified parameters for the object h and returns them in the n-element cell array data.

The input h is the handle of a circuit object.

parameter1,..., parameterN is the list of parameters to be calculated. Use the listparam method to get a list of the valid parameters for a circuit object.

format is the format of the output data. The format determines if RF Toolbox software converts the parameter values to a new set of units, or operates on the components of complex parameter values.

For example:

- Specify format as Real to compute the real part of the selected parameter.
  - Specify format as 'none' to return the parameter values unchanged.
- Use the listformat method to get a list of the valid formats for a particular parameter.

The output params is an n-element cell array containing the names, as strings, of the parameters in data. freq is a vector of frequencies at which the parameters are known.

---

**Note** Before calling calculate, you must use the analyze method to perform a frequency domain analysis for the circuit object.

---

```
[ydata,params,xdata] = calculate(h, 'parameter1', ..., 'parameterN',
'format', xparameter, xformat,
'condition1', value1, ..., 'conditionM', valuem,
'freq', freq, 'pin', pin) calculates the specified parameters at the
specified operating conditions for the object h.
```

xparameter is the independent parameter for which to calculate the specified parameters. Several xparameter values are available for all objects. When you import rfckt.amplifier, rfckt.mixer, or rfddata.data object specifications from a .p2d or .s2d file, you can also specify any operating conditions from the file that have numeric values, such as bias.

The following table shows the most commonly available parameters and the corresponding xparameter values. The default settings listed in the table are used if xparameter is not specified.

Parameter Name	xparameter values
Pout, Phase, LS11, LS12, LS21, LS22	Pin (default), Freq
S11, S12, S21, S22, NF, IIP3, OIP3, GroupDelay, VSWRIn, VSWROut, GammaIn, GammaOut, FMIN, GammaOPT, RN, TF1, TF2, Gt, Ga, Gp, Gmag, Gmsg, GammaMS, GammaML, K, Delta, Mu, MuPrime	Freq
AM/AM, AM/PM	AM (default, and only available value)

xformat is the format to use for the specified xparameter. No xformat specification is needed when xparameter is an operating condition.

The following table shows the xformat values that are available for the xparameter values listed in the preceding table, along with the default settings that are used if xformat is not specified.

# calculate

---

xparameter values	xformat values
Pin	dBm (default), mW, W, dBW
Freq	THz, GHz, MHz, KHz, Hz By default, xformat is chosen to provide the best scaling for the given xparameter values.
AM	Magnitude (decibels) (default), Magnitude (linear)

condition1,value1,..., conditionm,valuem are the optional condition/value pairs at which to calculate the specified parameters. These pairs are usually operating conditions from a .p2d or .s2d file. For some parameters, you can specify a set of frequency or input power values at which to calculate the specified parameter.

For example:

- When you calculate large-signal S-parameters as a function of input power, you can specify frequency points of interest using condition/value pairs.
- When you calculate large-signal S-parameters as a function of frequency, you can specify input power levels of interest using condition/value pairs.
- When you calculate parameters as a function of an operating condition, you can specify both frequency and input power values using condition/value pairs.

freq is the optional frequency value at which to calculate the specified parameters.

pin is the optional input power value at which to calculate the specified parameters.



The method returns the following  $n$ -element cell arrays:

- `ydata` — The calculated values of the specified parameter.
- `params` — The names, as strings, of the parameters in `xdata` and `ydata`.
- `xdata` — The `xparameter` values at which the specified parameters are known.

---

**Note** For compatibility reasons, if `xdata` contains only one vector or if all `xdata` values are equal, then `xdata` is a numeric vector rather than a cell of a single vector.

---

If `h` has multiple operating conditions, such as from a `.p2d` or `.s2d` file, the `calculate` method operates as follows:

- If you do not specify any operating conditions as arguments to the `calculate` method, then the method returns the parameter values based on the currently selected operating condition.
- If one or more operating conditions are specified, the `calculate` method returns the parameter values based on those operating conditions.
- When an operating condition is used for the `xparameter` input argument, the `xdata` cell array returned by the `calculate` method contains the operating condition values in ascending order.

## Examples

Analyze a general transmission line, `trl`, with the default characteristic impedance of 50 ohms, phase velocity of 299792458 meters per second, and line length of 0.01 meters for frequencies of 1.0 GHz to 3.0 GHz. Then, calculate the  $S_{11}$  and  $S_{22}$  parameters in decibels.

```
trl = rfckt.txline;  
f = [1e9:1.0e7:3e9];  
analyze(trl,f);  
[data,params,freq] = calculate(trl,'S11','S22','dB')
```

# calculate

---

```
data =  
    [201x1 double]    [201x1 double]  
params =  
    'S_{11}'    'S_{22}'  
  
freq = 1.0e+009 *  
  
    1.0000  
    1.0100  
    1.0200  
    ...
```

The `params` output is formatted so you can use it as a plot legend. The first few elements of `data{1}` look like

```
ans =  
  
1.0e+003 *  
  
    -6.4661  
    -0.3372  
    -0.3432  
    -0.3432  
    -0.3432  
    ...
```

## See Also

`analyze` | `extract` | `getz0` | `listformat` | `listparam` | `loglog` |  
`plot` | `plotyy` | `polar` | `semilogx` | `semilogy` | `smith` | `read` |  
`restore` | `write`

**Purpose** Draw circles on Smith chart

**Syntax** `[hlines, hsm] = circle(h, freq, type1, value1, ..., typen, valuen, hsm)`

**Description** `[hlines, hsm] = circle(h, freq, type1, value1, ..., typen, valuen, hsm)` draws the specified circles on a Smith chart and returns the following handles:

- `hlines` — A vector of handles to line objects, with one handle per circle specification.
- `hsm` — The handle to the Smith chart.

The arguments to `circle` are:

- `h` — The handle to an `rfckt` object.
- `freq` — A single frequency point of interest.
- `type1, value1, ..., typen, valuen` — The type/value pairs that specify the circles to plot.

The following table lists the supported circle `type` options and the definition of each option.

<b>type</b>	<b>Definition</b>
'Ga'	Constant available power gain circle
'Gp'	Constant operating power gain circle
'Gt'	Constant transducer power gain circle
'Stab'	Stability circle
'NF'	Constant noise figure circle
'R'	Constant resistance circle
'X'	Constant reactance circle
'G'	Constant conductance circle

# circle

type	Definition
'B'	Constant susceptance circle
'Gamma'	Constant reflection magnitude circle

The following table lists the available value options for the above types of circles and the definition of each value.

value	Definition
'Ga'	Scalar or vector of gains in dB
'Gp'	Scalar or vector of gains in dB
'Gt'	Scalar or vector of gains in dB
'Stab'	String 'in' or 'source' for input/source stability circle; string 'out' or 'load' for output/load stability circle
'NF'	Scalar or vector of noise figures in dB
'R'	Scalar or vector of normalized resistance
'X'	Scalar or vector of normalized reactance
'G'	Scalar or vector of normalized conductance
'B'	Scalar or vector of normalized susceptance
'Gamma'	Scalar or vector of non-negative reflection magnitude

hsm is an optional input argument that you can use to place circles on an existing Smith chart.

## Examples

For an example of how to use the `circle` method, see the RF Toolbox example *Designing Matching Networks (Part 1: Networks with an LNA and Lumped Elements)*.

## See Also

`smith`

---

<b>Purpose</b>	Extract array of network parameters from data object
<b>Syntax</b>	<code>[outmatrix, freq] = extract(h,outtype,z0)</code>
<b>Description</b>	<p><code>[outmatrix, freq] = extract(h,outtype,z0)</code> extracts the network parameters of <code>outtype</code> from an <code>rfckt</code>, <code>rfdata.data</code> or <code>rfdata.network</code> object, <code>h</code>, and returns them in <code>outmatrix</code>. <code>freq</code> is a vector of frequencies that correspond to the network parameters.</p> <p><code>outtype</code> can be one of these case-insensitive strings 'ABCD_parameters', 'S_parameters', 'Y_parameters', 'Z_parameters', 'H_parameters', 'G_parameters', or 'T_parameters'. <code>z0</code> is the reference impedance for the S-parameters. The default is 50 ohms.</p>
<b>See Also</b>	<code>analyze</code>   <code>calculate</code>   <code>getz0</code>   <code>listformat</code>   <code>listparam</code>   <code>loglog</code>   <code>plot</code>   <code>ploty</code>   <code>polar</code>   <code>semilogx</code>   <code>semilogy</code>   <code>smith</code>   <code>read</code>   <code>restore</code>   <code>write</code>

# freqresp

---

**Purpose** Frequency response of model object

**Syntax** `[resp,outfreq] = freqresp(h,infreq)`

**Description** `[resp,outfreq] = freqresp(h,infreq)` computes the frequency response, `resp`, of the `rfmodel` object, `h`, at the frequencies specified by `freq`.

The input `h` is the handle of a model object, and `infreq` is a vector of positive frequencies, in Hz, over which the frequency response is calculated.

The output argument `outfreq` is a vector that contains the same frequencies as the input frequency vector, in order of increasing frequency. The frequency response, `resp`, is a vector of frequency response values corresponding to these frequencies. It is computed using the analytical form of the rational function

$$resp = \left( \sum_{k=1}^n \frac{C_k}{s - A_k} + D \right) e^{-s * Delay}, \quad s = j2\pi * freq$$

where `A`, `C`, `D`, and `Delay` are properties of the `rfmodel` object, `h`.

## Examples

The following example shows you how to compute the frequency response of the data stored in the file `default.s2p` by reading it into an `rfdata` object, fitting a rational function model to the data, and using the `freqresp` method to compute the frequency response of the model.

```
orig_data=read(rfdata.data,'default.s2p')
freq=orig_data.Freq;
data=orig_data.S_Parameters(2,1,:);
fit_data=rationalfit(freq,data)

[resp,freq]=freqresp(fit_data,freq);

plot(freq/1e9,db(resp));
figure
```

```
plot(freq/1e9,unwrap(angle(resp)));
```

## See Also

[rationalfit](#) | [timeresp](#) | [writeva](#)

## How To

- [rfmodel.rational](#)

# getop

---

<b>Purpose</b>	Display operating conditions
<b>Syntax</b>	<code>getop(h)</code>
<b>Description</b>	<p><code>getop(h)</code> displays the selected operating conditions for the circuit or data object, <code>h</code>.</p> <p>Information about operating conditions is available only when you import the object specifications from a <code>.p2d</code> or <code>.s2d</code> file.</p>
<b>Examples</b>	<p>Display the operating conditions of an object:</p> <pre>ckt1 = read(rfckt.amplifier, 'default.p2d'); getop(ckt1)</pre>
<b>See Also</b>	<code>setop</code>



**Purpose** Find spurs in multiband transmitter or receiver frequency space

**Syntax** `spurs = getSpurData(hif)`

**Description** `spurs = getSpurData(hif)` returns a matrix of spur data for the network defined by the `OpenIF` object `hif`. Each spur is a range of frequencies. The two columns of `spurs` contain the endpoints of each spur. The first column contains the lower endpoints, and the second column contains the upper endpoints.

**Input Arguments** **hif**  
`OpenIF` object

**Examples**

- The `OpenIF` class reference page contains an example that shows how to find the spur-free zones of a multiband receiver with three mixers.
- The example `Finding Free IF Bandwidths` shows how to use information from a spur graph to design a multiband receiver with spur-free zones.

**See Also** `addMixer` | `report` | `getSpurFreeZoneData` | `OpenIF`

# getSpurFreeZoneData

---

**Purpose** Find spur-free zones in multiband transmitter or receiver frequency space

**Syntax** `zones = getSpurFreeZoneData(hif)`

**Description** `zones = getSpurFreeZoneData(hif)` returns the spur-free zones for the network defined by the `OpenIF` object `hif`. Each zone is a range of IF center frequencies. An IF signal centered in this range does not generate interference in any transmission or reception bands. The two columns of `zones` contain the endpoints of each spur-free zone. The first column contains the lower endpoints, and the second column contains the upper endpoints.

**Input Arguments** **hif**  
`OpenIF` object

**Alternatives**

- The `report` method displays mixer configurations, intermodulation tables, and spur-free zone information at the command line.
- The `show` method generates an interactive spur graph that shows spurious regions and spur-free zones.

**Examples**

- The `OpenIF` class reference page contains an example that shows how to find the spur-free zones of a multiband receiver with three mixers.
- The example `Finding Free IF Bandwidths` shows how to use information from a spur graph to design a multiband receiver with spur-free zones.

**See Also** `addMixer` | `getSpurData` | `report` | `show` | `OpenIF`

**Purpose** Characteristic impedance of transmission line object

**Syntax** `z0 = getz0(h)`

**Description** `z0 = getz0(h)` returns a scalar or vector, `z0`, that represents the characteristic impedance(s) of circuit object `h`. The object `h` can be `rfckt.txline`, `rfckt.rlcgline`, `rfckt.twowire`, `rfckt.parallelplate`, `rfckt.coaxial`, `rfckt.microstrip`, or `rfckt.cpw`.

**See Also** `analyze` | `calculate` | `extract` | `listformat` | `listparam` | `loglog` | `plot` | `plotyy` | `polar` | `semilogx` | `semilogy` | `smith` | `read` | `restore` | `write`

# impulse

---

**Purpose** Impulse response for model object

---

**Note** `impulse` may be removed in a future release. Use `timeresp` instead.

---

**Syntax** `[resp,t] = impulse(h,ts,n)`

**Description** `[resp,t] = impulse(h,ts,n)` computes the impulse response, `resp`, of the `rfmodel` object, `h`, over the time period specified by `ts` and `n`.

---

**Note** While you can compute the output response for a rational function model object by computing the impulse response of the object and then convolving that response with the input signal, this approach is not recommended. Instead, you should use the `timeresp` method to perform this computation because it generally gives a more accurate output signal for a given input signal.

---

The input `h` is the handle of a rational function model object. `ts` is a positive scalar value that specifies the sample time of the computed impulse response, and `n` is a positive integer that specifies the total number of samples in the response.

The vector of time samples of the impulse response, `t`, is computed from the inputs as `t = [0,ts,2*ts,...,(n-1)*ts]`. The impulse response, `resp`, is an `n`-element vector of impulse response values corresponding to these times. It is computed using the analytical form of the rational function

$$resp = \sum_{k=1}^M C_k e^{A_k(t-Delay)} u(t-Delay) + D\delta(t-Delay)$$

where

- A, C, D, and Delay are properties of the `rfmodel` object, `h`.
- M is the number of poles in the rational function model.

## Examples

The following example shows you how to compute the impulse response of the data stored in the file `default.s2p` by fitting a rational function model to the data and using the `impulse` method to compute the impulse response of the model.

```
orig_data=read(rfdata.data,'default.s2p')
freq=orig_data.Freq;
data=orig_data.S_Parameters(2,1,:);
fit_data=rationalfit(freq,data)

[resp,t]=impulse(fit_data,1e-12,1e4);

plot(t,resp);
```

## See Also

`freqresp` | `rationalfit` | `writeva`

## How To

- `rfmodel.rational`

# ispassive

---

**Purpose** Check passivity of scalar model object

**Syntax** `result = ispassive(h)`

**Description** `result = ispassive(h)` checks the passivity of the `rfmodel` object, `h`, across all frequencies, and returns `result`, a logical value. If `h` is passive, then `result` is 1. If `h` is not passive, then `result` is 0.

**Examples** Create a scalar model object and check the passivity of the object:

```
% Read a Touchstone data file
ckt = read(rfckt.passive, 'passive.s2p');
% Fit the transfer function into a rational function object
TF = s2tf(ckt.AnalyzedResult.S_Parameters);
TF_Object = rationalfit(ckt.AnalyzedResult.Freq, TF);
% Check the passivity of the rational function object
Is_Passive = ispassive(TF_Object)
```

**See Also** `rfmodel.rational` | `rationalfit`

**Purpose** List valid formats for specified circuit object parameter

**Syntax** `list = listformat(h,'parameter')`

**Description** `list = listformat(h,'parameter')` lists the allowable formats for the specified network parameter. The first listed format is the default format for the specified parameter.

In these lists, 'Abs' and 'Mag' are the same as 'Magnitude (linear)', and 'Angle' is the same as 'Angle (degrees)'.

When you plot phase information as a function of frequency, RF Toolbox software unwraps the phase data using the MATLAB `unwrap` function. The resulting plot is only meaningful if the phase data varies smoothly as a function of frequency, as described in the `unwrap` reference page. If your data does not meet this requirement, you must obtain data on a finer frequency grid.

Use the `listparam` method to get the valid parameters of a circuit object.

---

**Note** Before calling `listformat`, you must use the `analyze` method to perform a frequency domain analysis for the circuit object.

---

**Examples**

```
trl = rfckt.txline;
f = [1e9:1.0e7:3e9];
analyze(trl,f);
list = listformat(trl,'S11')

list =
    'dB'
    'Magnitude (decibels)'
    'Abs'
    'Mag'
    'Magnitude (linear)'
    'Angle'
```

# listformat

---

```
'Angle (degrees)'  
'Angle (radians)'  
'Real'  
'Imag'  
'Imaginary'
```

## See Also

```
analyze | calculate | extract | getz0 | listparam | loglog | plot  
| plotyy | polar | semilogx | semilogy | smith | read | restore  
| write
```



**Purpose** List valid parameters for specified circuit object

**Syntax** `list = listparam(h)`

**Description** `list = listparam(h)` lists the valid parameters for the specified circuit object `h`.

---

**Note** Before calling `listparam`, you must use the `analyze` method to perform a frequency domain analysis for the circuit object.

---

Several parameters are available for all objects. When you import `rfckt.amplifier`, `rfckt.mixer`, or `rfdata.data` object specifications from a `.p2d` or `.s2d` file, the list of valid parameters also includes any operating conditions from the file that have numeric values, such as bias.

The following table describes the most commonly available parameters.

Parameter	Description
S11, S12, S21, S22 LS11, LS12, LS21, LS22 (Amplifier and mixer objects with multiple operating conditions only)	S-parameters
GroupDelay	Group delay
GammaIn, GammaOut	Input and output reflection coefficients
VSWRIn, VSWRout	Input and output voltage standing-wave ratio
IIP3, OIP3 (Amplifier and mixer objects only)	Third-order intercept point
NF	Noise figure

# listparam

Parameter	Description
TF1	Ratio of the load voltage to the output voltage of the source when the input port is conjugate matched
TF2	Ratio of load voltage to the source voltage
<ul style="list-style-type: none"><li>• Gt</li><li>• Ga</li><li>• Gp</li><li>• Gmag</li><li>• Gmsg</li></ul>	<ul style="list-style-type: none"><li>• Transducer power gain</li><li>• Available power gain</li><li>• Operating power gain</li><li>• Maximum available power gain</li><li>• Maximum stable gain</li></ul>
GammaMS, GammaML	Source and load reflection coefficients for simultaneous conjugate match
K, Mu, MuPrime	Stability factor
Delta	Stability condition

## Examples

The following examples show you how to list the parameters for a transmission line object.

```
trl = rfckt.txline;  
f = [1e9:1.0e7:3e9];  
analyze(trl,f);  
list = listparam(trl)
```

## See Also

analyze | calculate | extract | getz0 | listformat | loglog |  
plot | plotty | polar | semilogx | semilogy | smith | read |  
restore | write

---

<b>Purpose</b>	Plot specified circuit object parameters using log-log scale
<b>Syntax</b>	<pre>lineseries = loglog(h,parameter) lineseries = loglog(h,parameter1,...,parametern) lineseries = loglog(h,parameter1,...,parametern,format) lineseries = loglog(h,'parameter1',...,'parametern', format,     xparameter,xformat,'condition1',value1,..., 'conditionm',     valuem,'freq',freq,'pin',pin)</pre>
<b>Description</b>	<p><code>lineseries = loglog(h,parameter)</code> plots the specified parameter in the default format using a log-log scale. <code>h</code> is the handle of a circuit (rfckt) object.</p> <p>Type <code>listparam(h)</code> to get a list of valid parameters for a circuit object, <code>h</code>. Type <code>listformat(h,parameter)</code> to see the legitimate formats for a specified parameter. The first listed format is the default for the specified parameter.</p> <p>The <code>loglog</code> method returns a column vector of handles to <code>lineseries</code> objects, one handle per line. This output is the same as the output returned by the MATLAB <code>loglog</code> method.</p> <p><code>lineseries = loglog(h,parameter1,...,parametern)</code> plots the parameters <code>parameter1,..., parametern</code> from the object <code>h</code> on an X-Y plane using logarithmic scales for both the <i>x</i>- and <i>y</i>- axes.</p> <p><code>lineseries = loglog(h,parameter1,...,parametern,format)</code> plots the parameters <code>parameter1,..., parametern</code> in the specified format. <code>format</code> is the format of the data to be plotted, e.g. 'Magnitude (decibels)'.</p>

---

**Note** For all circuit objects except those that contain data from a data file, you must perform a frequency domain analysis with the `analyze` method before calling `loglog`.

---

Use the Property Editor (`propertyeditor`) or the MATLAB `set` function to change `lineseries` properties. The reference pages for

MATLAB functions such as `figure`, `axes`, and `text` also list available properties and provide links to more complete property descriptions.

---

**Note** Use the MATLAB `loglog` function to create a log-log scale plot of parameters that are specified as vector data and are not part of a circuit (`rfckt`) object or data (`rfdata`) object.

---

```
lineseries = loglog(h,'parameter1',...,'parameterN',  
format,xparameter,xformat,'condition1',value1,...,  
'conditionM',valueM,'freq',freq,'pin',pin) plots the specified  
parameters at the specified operating conditions for the object h.
```

`xparameter` is the independent variable to use in plotting the specified parameters. Several `xparameter` values are available for all objects. When you import `rfckt.amplifier`, `rfckt.mixer`, or `rfdata.data` object specifications from a `.p2d` or `.s2d` file, you can also specify any operating conditions from the file that have numeric values, such as bias.

The following table shows the most commonly available parameters and the corresponding `xparameter` values. The default settings listed in the table are used if `xparameter` is not specified.

Parameter Name	xparameter values
Pout, Phase, LS11, LS12, LS21, LS22	Pin (default), Freq
S11, S12, S21, S22, NF, IIP3, OIP3, GroupDelay, VSWRIn, VSWROut, GammaIn, GammaOut, FMIN, GammaOPT, RN, TF1, TF2, Gt, Ga, Gp, Gmag, Gmsg, GammaMS, GammaML, K, Delta, Mu, MuPrime	Freq
AM/AM, AM/PM	AM

`xformat` is the format to use for the specified `xparameter`. No `xformat` specification is needed when `xparameter` is an operating condition.

The following table shows the `xformat` values that are available for the `xparameter` values listed in the preceding table, along with the default settings that are used if `xformat` is not specified.

<b>xparameter values</b>	<b>xformat values</b>
Pin	dBm (default), mW, W, dBW
Freq	THz, GHz, MHz, KHz, Hz  By default, <code>xformat</code> is chosen to provide the best scaling for the given <code>xparameter</code> values.
AM	Magnitude (decibels) (default), Magnitude (linear)

`condition1,value1,...,conditionm,valuem` are the optional condition/value pairs at which to plot the specified parameters. These pairs are usually operating conditions from a `.p2d` or `.s2d` file. For some parameters, you can specify a set of frequency or input power values at which to plot the specified parameter.

For example:

- When plotting large-signal S-parameters as a function of input power, you can specify frequency points of interest using condition/value pairs.
- When plotting large-signal S-parameters as a function of frequency, you can specify input power levels of interest using condition/value pairs.
- When plotting parameters as a function of an operating condition, you can specify both frequency and input power values using condition/value pairs.

`freq` is the optional frequency value, in hertz, at which to plot the specified parameters.

# loglog

---

`pin` is the optional input power value, in dBm, at which to plot the specified parameters.

If `h` has multiple operating conditions, such as from a `.p2d` or `.s2d` file, the `loglog` method operates as follows:

- If you do not specify any operating conditions as arguments to the `loglog` method, then the method plots the parameter values based on the currently selected operating condition.
- If you specify one or more operating conditions, the `loglog` method plots the parameter values based on those operating conditions.
- When you use an operating condition for the `xparameter` input argument, the method plots the parameters for all operating condition values.

## See Also

`analyze` | `calculate` | `extract` | `getz0` | `listformat` | `listparam` | `plot` | `plotyy` | `polar` | `read` | `restore` | `semilogx` | `semilogy` | `smith` | `write`

**Purpose**

Plot specified circuit object parameters on X-Y plane

**Syntax**

```
lineseries = plot(h,parameter)
lineseries = plot(h,parameter1,...,parametern)
lineseries = plot(h,parameter1,...,parametern,format)
lineseries = plot(h,'parameter1',...,'parametern',format,
    xparameter,xformat,'condition1',value1,...,'conditionm',
    valuem,'freq',freq,'pin',pin)
lineseries = plot(h,'budget',...)
lineseries = plot(h,'mixerspur',k,pin,fin)
```

**Description**

`lineseries = plot(h,parameter)` plots the specified parameter on an X-Y plane in the default format. `h` is the handle of a circuit (rfckt) object. Use the `listparam` method to get a list of the valid parameters for a particular circuit object, `h`.

The `plot` method returns a column vector of handles to `lineseries` objects, one handle per line. This output is the same as the output returned by the MATLAB `plot` function.

`lineseries = plot(h,parameter1,...,parametern)` plots the specified parameters `parameter1,..., parametern` from the object `h` on an X-Y plane.

`lineseries = plot(h,parameter1,...,parametern,format)` plots the specified parameters `parameter1,..., parametern` in the specified format. The format determines if RF Toolbox software converts the parameter values to a new set of units, or operates on the components of complex parameter values. For example:

- Specify format as `Real` to plot the real part of the selected parameter.
- Specify format as `'none'` to plot the parameter values unchanged.

Use the `listformat` method to get a list of the valid formats for a particular parameter.

`lineseries = plot(h, 'parameter1', ..., 'parameterN', format, xparameter, xformat, 'condition1', value1, ..., 'conditionM', valueM, 'freq', freq, 'pin', pin)` plots the specified parameters at the specified operating conditions for the object `h`.

`xparameter` is the independent variable to use in plotting the specified parameters. Several `xparameter` values are available for all objects. When you import `rfckt.amplifier`, `rfckt.mixer`, or `rfdata.data` object specifications from a `.p2d` or `.s2d` file, you can also specify any operating conditions from the file that have numeric values, such as bias.

The following table shows the most commonly available parameters and the corresponding `xparameter` values. The default settings listed in the table are used if `xparameter` is not specified.

Parameter Name	xparameter values
Pout, Phase, LS11, LS12, LS21, LS22	Pin (default), Freq
S11, S12, S21, S22, NF, IIP3, OIP3, GroupDelay, VSWRIn, VSWROut, GammaIn, GammaOut, FMIN, GammaOPT, RN, TF1, TF2, Gt, Ga, Gp, Gmag, Gmsg, GammaMS, GammaML, K, Delta, Mu, MuPrime	Freq
AM/AM, AM/PM	AM

`xformat` is the format to use for the specified `xparameter`. No `xformat` specification is needed when `xparameter` is an operating condition.

The following table shows the `xformat` values that are available for the `xparameter` values listed in the preceding table, along with the default settings that are used if `xformat` is not specified.



xparameter values	xformat values
Pin	dBm (default), mW, W, dBW
Freq	THz, GHz, MHz, KHz, Hz By default, xformat is chosen to provide the best scaling for the given xparameter values.
AM	Magnitude (decibels) (default), Magnitude (linear)

condition1,value1,..., conditionm,valuem are the optional condition/value pairs at which to plot the specified parameters. These pairs are usually operating conditions from a .p2d or .s2d file. For some parameters, you can specify a set of frequency or input power values at which to plot the specified parameter.

For example:

- When plotting large-signal S-parameters as a function of input power, you can specify frequency points of interest using condition/value pairs.
- When plotting large-signal S-parameters as a function of frequency, you can specify input power levels of interest using condition/value pairs.
- When plotting parameters as a function of an operating condition, you can specify both frequency and input power values using condition/value pairs.

freq is the optional frequency value, in hertz, at which to plot the specified parameters.

pin is the optional input power value, in dBm, at which to plot the specified parameters.

If h has multiple operating conditions, such as from a .p2d or .s2d file, the plot method operates as follows:

- If you do not specify any operating conditions as arguments to the `plot` method, then the method plots the parameter values based on the currently selected operating condition.
- If you specify one or more operating conditions, the `plot` method plots the parameter values based on those operating conditions.
- When you use an operating condition for the `xparameter` input argument, the method plots the parameters for all operating condition values.

`lineseries = plot(h, 'budget', ...)` plots budget data for the specified parameters `parameter1, ..., parameterN` from the `rfckt.cascade` object `h`.

The following table summarizes the parameters and formats that are available for a budget plot.

Parameter	Format
S11, S12, S21, S22	Magnitude (decibels) Magnitude (linear) Angle (degrees) Real Imaginary
OIP3	dBm dBW W mW
NF	Magnitude (decibels) Magnitude (linear)

`lineseries = plot(h, 'mixerspurs', k, pin, fin)` plots spur power of an `rfckt.mixer` object or an `rfckt.cascade` object that contains one or more mixers.

`k` is the index of the circuit object for which to plot spur power. Its value can be an integer or 'all'. The default is 'all'. This value

---

creates a budget plot of the spur power for `h`. Use 0 to plot the power at the input of `h`.

`pin` is the optional scalar input power value, in dBm, at which to plot the spur power. The default is 0 dBm. When you create a spur plot for an object, the previous input power value is used for subsequent plots until you specify a different value.

`fin` is the optional scalar input frequency value, in hertz, at which to plot the spur power. If `h` is an `rfckt.mixer` object, the default value of `fin` is the input frequency at which the magnitude of the  $S_{21}$  parameter of the mixer, in decibels, is highest. If `h` is an `rfckt.cascde` object, the default value of `fin` is the input frequency at which the magnitude of the  $S_{21}$  parameter of the first mixer in the cascade is highest. When you create a spur plot for an object, the previous input frequency value is used for subsequent plots until you specify a different value.

For more information on plotting mixer spur power, see the Visualizing Mixer Spurs example.

---

**Note** For all circuit objects except those that contain data from a data file, you must perform a frequency domain analysis with the `analyze` method before calling `plot`.

---

Use the Property Editor (`propertyeditor`) or the MATLAB `set` function to change `lineseries` properties. The reference pages for MATLAB functions such as `figure`, `axes`, and `text` also list available properties and provide links to more complete property descriptions.

---

**Note** Use the MATLAB `plot` function to plot network parameters that are specified as vector data and are not part of a circuit (`rfckt`) object or data (`rfdata`) object.

---

**Alternatives**

The `rfplot` function creates magnitude-frequency plots for RF Toolbox S-parameter objects.

**See Also**

`analyze` | `calculate` | `extract` | `getz0` | `listformat` | `listparam`  
| `loglog` | `plotyy` | `polar` | `read` | `restore` | `rfplot` | `semilogx` |  
`semilogy` | `smith` | `write`

## Purpose

Plot specified object parameters with *y*-axes on both left and right sides

## Syntax

```
[ax,hlines1,hlines2] = plotyy(h,parameter)
[ax,hlines1,hlines2] = plotyy(h,parameter1,...,parametern)
[ax,hlines1,hlines2] = plotyy(h,parameter,format1,format2)
[ax,hlines1,hlines2] = plotyy(h, parameter1, ..., parametern,
    format1, format2)
[ax,hlines1,hlines2] = plotyy(h,parameter1_1,...,
    parameter1_n1, format1,parameter2_1,...,parameter2_n2,
    format2)
[ax,hlines1,hlines2] = plotyy(h,parameter1_1,...,parameter1_n1,
    format1,parameter2_1,...,parameter2_n2,format2,xparameter,
    xformat,'condition1',value1,...,'conditionm',valuem,
    'freq',freq,'pin',pin)
```

## Description

[ax,hlines1,hlines2] = plotyy(h,parameter) plots the specified parameter using the predefined primary and secondary formats for the left and right *y*-axes, respectively. The formats define how RF Toolbox software displays the data on the plot. *h* is the handle of a circuit (rfckt) or an rfddata.data object.

- See “Determining Formats” on page 9-43 for a table that shows the predefined primary and secondary formats for the parameters for all circuit and data objects.
- Type listparam(*h*) to get a list of valid parameters for a circuit object, *h*. Type listformat(*h*,parameter) to see the legitimate formats for a specified parameter. The first listed format is the default for the specified parameter.

The plotyy method returns the handles to the two axes created in *ax* and the handles to two lineseries objects in *hlines1* and *hlines2*.

- *ax*(1) is the left axes.
- *ax*(2) is the right axes.
- *hlines1* is the lineseries object for the left *y*-axis.
- *hlines2* is the lineseries object for the right *y*-axis.

---

**Note** For all circuit objects except those that contain data from a data file, you must perform a frequency domain analysis with the `analyze` method before calling `plotyy`.

---

Use the Property Editor (`propertyeditor`) or the MATLAB `set` function to change `lineseries` properties. The reference pages for MATLAB functions such as `figure`, `axes`, and `text` also list available properties and provide links to more complete property descriptions.

---

**Note** Use the MATLAB `plotyy` function to plot parameters on two  $y$ -axes that are specified as vector data and are not part of a circuit (`rfckt`) object or data (`rfddata`) object.

---

`[ax,hlines1,hlines2] = plotyy(h,parameter1,...,parameterN)`  
plots the parameters `parameter1,...,parameterN`. `plotyy` determines the formats for the left and right  $y$ -axes based on the predefined primary and secondary formats for the specified parameters, as described in “Determining Formats” on page 9-43.

`[ax,hlines1,hlines2] = plotyy(h,parameter,format1,format2)`  
plots the specified parameter using `format1` for the left  $y$ -axis and `format2` for the right  $y$ -axis.

`[ax,hlines1,hlines2] = plotyy(h, parameter1,  
..., parameterN, format1, format2)` plots the  
parameters `parameter1,...,parameterN` on an X-Y plane  
using `format1` for the left  $y$ -axis and `format2` for the right  $y$ -axis.

`[ax,hlines1,hlines2] =  
plotyy(h,parameter1_1,...,parameter1_n1,  
format1,parameter2_1,...,parameter2_n2,format2)` plots the  
following data:

- Parameters `parameter1_1, ..., parameter1_n1` using `format1` for the left *y*-axis.
- Parameters `parameter2_1, ..., parameter2_n2` using `format2` for the right *y*-axis.

```
[ax,hlines1,hlines2] = plotyy(h,parameter1_1,...,parameter1_n1,
format1,parameter2_1,...,parameter2_n2,format2,xparameter,
xformat,'condition1',value1,...,'conditionm',valuem,
'freq',freq,'pin',pin) plots the specified parameters at the
specified operating conditions for the object h.
```

`xparameter` is the independent variable to use in plotting the specified parameters. Several `xparameter` values are available for all objects. When you import `rfckt.amplifier`, `rfckt.mixer`, or `rfdata.data` object specifications from a `.p2d` or `.s2d` file, you can also specify any operating conditions from the file that have numeric values, such as bias.

The following table shows the most commonly available parameters and the corresponding `xparameter` values. The default settings listed in the table are used if `xparameter` is not specified.

Parameter Name	xparameter values
Pout, Phase, LS11, LS12, LS21, LS22	Pin (default), Freq
S11, S12, S21, S22, NF, IIP3, OIP3, GroupDelay, VSWRIn, VSWROut, GammaIn, GammaOut, FMIN, GammaOPT, RN, TF1, TF2, Gt, Ga, Gp, Gmag, Gmsg, GammaMS, GammaML, K, Delta, Mu, MuPrime	Freq
AM/AM, AM/PM	AM

`xformat` is the format to use for the specified `xparameter`. No `xformat` specification is needed when `xparameter` is an operating condition.

The following table shows the `xformat` values that are available for the `xparameter` values listed in the preceding table, along with the default settings that are used if `xformat` is not specified.

<b>xparameter values</b>	<b>xformat values</b>
Pin	dBm (default), mW, W, dBW
Freq	THz, GHz, MHz, KHz, Hz  By default, <code>xformat</code> is chosen to provide the best scaling for the given <code>xparameter</code> values.
AM	Magnitude (decibels) (default), Magnitude (linear)

`condition1,value1,...,conditionm,valuem` are the optional condition/value pairs at which to plot the specified parameters. These pairs are usually operating conditions from a `.p2d` or `.s2d` file. For some parameters, you can specify a set of frequency or input power values at which to plot the specified parameter.

For example:

- When plotting large-signal S-parameters as a function of input power, you can specify frequency points of interest using condition/value pairs.
- When plotting large-signal S-parameters as a function of frequency, you can specify input power levels of interest using condition/value pairs.
- When plotting parameters as a function of an operating condition, you can specify both frequency and input power values using condition/value pairs.

`freq` is the optional frequency value, in hertz, at which to plot the specified parameters.

`pin` is the optional input power value, in dBm, at which to plot the specified parameters.



If `h` has multiple operating conditions, such as from a `.p2d` or `.s2d` file, the `plotyy` method operates as follows:

- If you do not specify any operating conditions as arguments to the `plotyy` method, then the method plots the parameter values based on the currently selected operating condition.
- If you specify one or more operating conditions, the `plotyy` method plots the parameter values based on those operating conditions.
- When you use an operating condition for the `xparameter` input argument, the method plots the parameters for all operating condition values.

## Determining Formats

When you call `plotyy` without specifying the plot formats for the left and right *y*-axes, `plotyy` determines the formats from the predefined primary and secondary formats for the one or more specified parameters.

This section contains the following topics:

- “Primary and Secondary Formats” on page 9-43
- “Determining Formats for One Parameter” on page 9-45
- “Determining Formats for Multiple Parameters” on page 9-45

### Primary and Secondary Formats

The following table shows the primary and secondary formats for the parameters for all circuit and data objects. Use the `listparam` method to list the valid parameters for a particular object. Use the `listformat` method to list valid formats.

Parameter	Primary Format	Secondary Format
S11, S12, S21, S22	Magnitude (decibels)	Angle (Degrees)
LS11, LS12, LS21, LS22	Magnitude (decibels)	Angle (Degrees)

<b>Parameter</b>	<b>Primary Format</b>	<b>Secondary Format</b>
NF	Magnitude (decibels)	
OIP3	dBm	W
Pout	dBm	W
Phase	Angle (Degrees)	
AM/AM	Magnitude (decibels)	
AM/PM	Angle (Degrees)	
GammaIn, GammaOut	Magnitude (decibels)	Angle (Degrees)
Gt, Ga, Gp, Gmag, Gmsg	Magnitude (decibels)	
Delta	Magnitude (decibels)	Angle (Degrees)
TF1, TF2	Magnitude (decibels)	Angle (Degrees)
GammaMS, GammaML	Magnitude (decibels)	Angle (Degrees)
VSWRIn, VSWROut	Magnitude (decibels)	
GroupDelay	ns	
Fmin	Magnitude (decibels)	
GammaOPT	Magnitude (decibels)	Angle (Degrees)
K, Mu, MuPrime	None	
RN	None	
PhaseNoise	dBc/Hz	

Parameter	Primary Format	Secondary Format
NTemp	K	
NFactor	None	

### Determining Formats for One Parameter

When you specify only one parameter for plotting, `plotyy` creates the plot as follows:

- The predefined primary format is the format for the left  $y$ -axis.
- The predefined secondary format is the format for the right  $y$ -axis.

If the specified parameter does not have the predefined secondary format, `plotyy` behaves the same way as `plot`, and does not add a second  $y$ -axis to the plot.

### Determining Formats for Multiple Parameters

To plot multiple parameters on two  $y$ -axes, `plotyy` tries to find two formats from the predefined primary and secondary formats for the specified parameters. To be used in the plot, the formats must meet the following criteria:

- Each format must be a valid format for at least one parameter.
- Each parameter must be plotted at least on one  $y$ -axis.

If `plotyy` cannot meet this criteria it issues an error message.

The function uses the following algorithm to determine the two parameters:

- 1 Look up the primary and secondary formats for the specified parameters.
- 2 If one or more pairs of primary-secondary formats meets the preceding criteria for all parameters:
  - Select the pair that applies to the most parameters.
  - Use these formats to create the plot.
 Otherwise, proceed to the next step.

**3** If no pairs of primary-secondary formats meet the criteria for all parameters, try to find one or more pairs of primary-primary formats that meets the criteria. If one or more pairs of primary-primary formats meets the preceding criteria for all parameters:

- Select the pair that applies to the most parameters.
- Use these formats to create the plot.

Otherwise, proceed to the next step.

**4** If the preceding steps fail to produce a plot, try to find one format from the predefined primary formats. If a primary format is valid for all parameters, use this format to create the plot with the MATLAB plot function.

If this is not successful, issue an error message.

The following example shows how plotyy applies this criteria to create plots.

### **Example – Determining Formats for Multiple Parameters**

At the MATLAB prompt:

**1** Type this command to create an rfckt object called amp:

```
amp = rfckt.amplifier;
```

**2** Type this command to plot the S11 and S21 parameters of amp on two y-axes:

```
plotyy(amp, 'S11', 'S21')
```

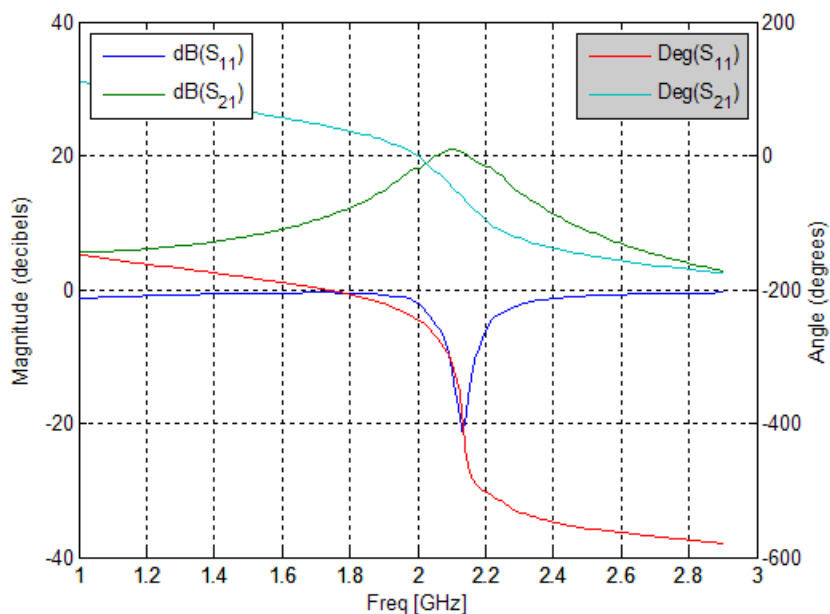

The primary and secondary formats for both S11 and S21 are Magnitude (decibels) and Angle (Degrees), respectively, so plotyy uses this primary-secondary format pair to create the plot.

- 3 Type this command to plot the S11 and NF parameters of amp on two y-axes:

```
plotyy(amp, 'S11', 'NF')
```

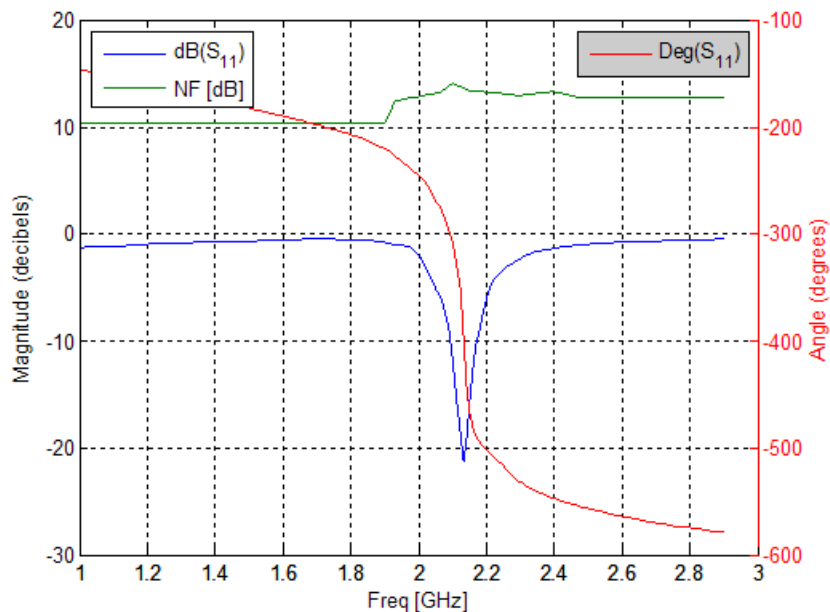

The primary and secondary formats for S11 are Magnitude (decibels) and Angle (Degrees), respectively.

- Magnitude (decibels) is a valid format for both S11 and NF
- Angle (Degrees) is a valid format for S11.

These formats both meet the preceding criteria, so the function uses this primary-secondary format pair to create the plot.

- 4 Type this command to plot the NF, S21 and GroupDelay parameters of amp on two y-axes:

```
plotyy(amp, 'NF', 'S21', 'GroupDelay')
```

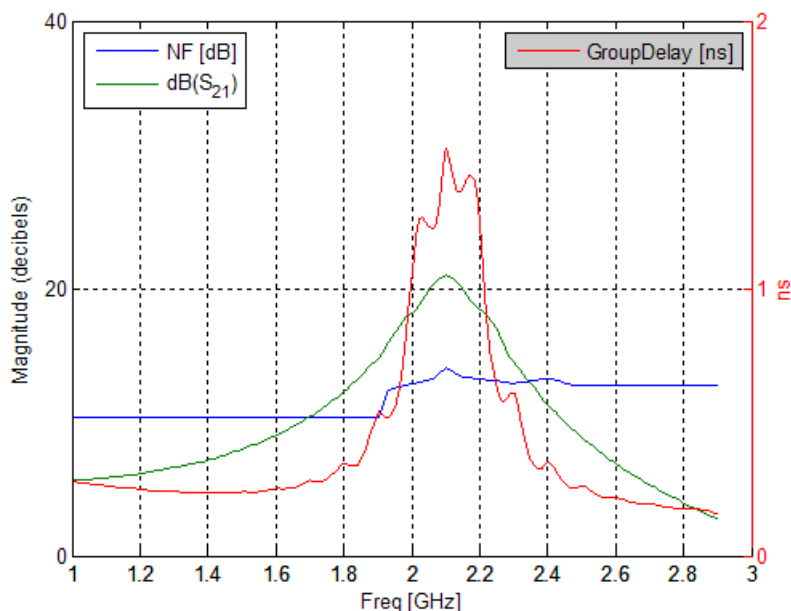

The primary and secondary formats for S21 are Magnitude (decibels) and Angle (Degrees), respectively. Both NF and GroupDelay have only a primary format.

- Magnitude (decibels) is the primary format for NF.
  - ns is the primary format for GroupDelay.
- There is no primary-secondary format pair that meets the preceding criteria, so plotyy tries to find a pair of primary formats that meet the criteria. plotyy creates the plot using:

- Magnitude (decibels) for the left y-axis.

This format is valid for both NF and S21.

- ns for the right y-axis.

This format is valid for GroupDelay .

These formats meet the criteria.

- 5 Type this command to plot the NFactor and K parameters of amp on two y-axes:

```
plotyy(amp, 'NFactor', 'K')
```

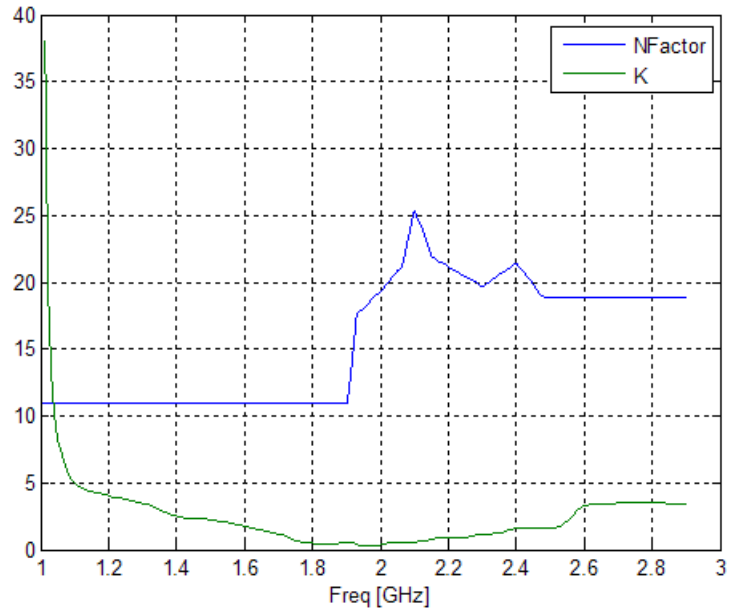

Both NFactor and K have only a primary format, None, so plotyy calls the plot command to create a plot with a single y-axis whose format is None.

- 6 Type this command to plot the NTemp, S21 and NFactor parameters of amp on two y-axes:

```
plotyy(amp, 'NTemp', 'S21', 'NFactor')
```

```
??? Error using ==> rfdata.data.plotyyprocess at 97  
No format specified for input parameters and cannot reconcile  
default formats. Try reducing the number of parameters to plotyy  
and explicitly specifying formats.
```



The primary and secondary formats for S21 are Magnitude (decibels) and Angle (Degrees), respectively. Both NTemp and NFactor have only a primary format.

- Kelvin is the primary format for NTemp.
- None is the primary format for NFactor.

These parameters have no formats in common, so no formats meet the criteria and plotyy issues an error message.

### See Also

analyze | calculate | extract | getz0 | listformat | listparam  
| loglog | plot | polar | read | restore | semilogx | semilogy |  
smith | write

# polar

---

## Purpose

Plot specified circuit object parameters on polar coordinates

## Syntax

```
lineseries = polar(h,'parameter1',...,'parameterN')  
lineseries = polar(h,'parameter1',...,'parameterN', xparameter,  
    xformat,'condition1',value1,..., 'conditionM',valuem,  
    'freq',freq,'pin',pin)
```

## Description

`lineseries = polar(h,'parameter1',...,'parameterN')` plots the parameters `parameter1`,..., `parameterN` from the object `h` on polar coordinates. `h` is the handle of a circuit (`rfckt`) object.

`polar` returns a column vector of handles to `lineseries` objects, one handle per line. This is the same as the output returned by the MATLAB `polar` function.

Type `listparam(h)` to get a list of valid parameters for a circuit object `h`.

---

**Note** For all circuit objects except those that contain data from a data file, you must use the `analyze` method to perform a frequency domain analysis before calling `polar`.

---

Use the Property Editor (`propertyeditor`) or the MATLAB `set` function to change the `lineseries` properties. The reference pages for MATLAB functions such as `figure`, `axes`, and `text` list available properties and provide links to more complete descriptions.

---

**Note** Use the MATLAB `polar` function to plot parameters that are not part of a circuit (`rfckt`) object, but are specified as vector data.

---

```
lineseries = polar(h,'parameter1',...,'parameterN',  
xparameter,xformat,'condition1',value1,...,  
'conditionM',valuem, 'freq',freq,'pin',pin) plots the  
specified parameters at the specified operating conditions for the object  
h.
```

xparameter is the independent variable to use in plotting the specified parameters. Several xparameter values are available for all objects. When you import rfckt.amplifier, rfckt.mixer, or rfdata.data object specifications from a .p2d or .s2d file, you can also specify any operating conditions from the file that have numeric values, such as bias.

The following table shows the most commonly available parameters and the corresponding xparameter values. The default settings listed in the table are used if xparameter is not specified.

Parameter Name	xparameter values
Pout, Phase, LS11, LS12, LS21, LS22	Pin (default), Freq
S11, S12, S21, S22, NF, OIP3, VSWRIn, VSWROut, GammaIn, GammaOut, FMIN, GammaOPT, RN	Freq
AM/AM, AM/PM	AM

xformat is the format to use for the specified xparameter. No xformat specification is needed when xparameter is an operating condition.

The following table shows the xformat values that are available for the xparameter values listed in the preceding table, along with the default settings that are used if xformat is not specified.

xparameter values	xformat values
Pin	dBm (default), mW, W, dBW
Freq	THz, GHz, MHz, KHz, Hz By default, xformat is chosen to provide the best scaling for the given xparameter values.
AM	Magnitude (decibels) (default), Magnitude (linear)

`condition1,value1,...,conditionm,valuem` are the optional condition/value pairs at which to plot the specified parameters. These pairs are usually operating conditions from a `.p2d` or `.s2d` file. For some parameters, you can specify a set of frequency or input power values at which to plot the specified parameter.

For example:

- When plotting large-signal S-parameters as a function of input power, you can specify frequency points of interest using condition/value pairs.
- When plotting large-signal S-parameters as a function of frequency, you can specify input power levels of interest using condition/value pairs.
- When plotting parameters as a function of an operating condition, you can specify both frequency and input power values using condition/value pairs.

`freq` is the optional frequency value, in hertz, at which to plot the specified parameters.

`pin` is the optional input power value, in dBm, at which to plot the specified parameters.

If `h` has multiple operating conditions, such as from a `.p2d` or `.s2d` file, the `polar` method operates as follows:

- If you do not specify any operating conditions as arguments to the `polar` method, then the method plots the parameter values based on the currently selected operating condition.
- If you specify one or more operating conditions, the `polar` method plots the parameter values based on those operating conditions.
- When you use an operating condition for the `xparameter` input argument, the method plots the parameters for all operating condition values.

**See Also**

analyze | calculate | extract | getz0 | listformat | listparam |  
loglog | plot | plotyy | read | restore | semilogx | semilogy |  
smith | write

## Purpose

Read RF data from file to new or existing circuit or data object

## Syntax

```
h = read(h)
h = read(h,filename)
h = read(rfckt.datafile,filename)
h = read(rfckt.passive,filename)
h = read(rfckt.amplifier,filename)
h = read(rfckt.mixer,filename)
h = read(rfdata.data,filename)
```

## Description

`h = read(h)` prompts you to select a file and then reads the data from that file into the circuit or data object, `h`. You can read data from an `.snp`, `.ynp`, `.znp`, `.hnp`, `.gnp`, or `.amp` file, where `n` is the number of ports. If `h` is an `rfckt.amplifier`, `rfckt.mixer`, or `rfdata.data` object, you can also read data from `.p2d` and `.s2d` files.

For an example of how to use RF Toolbox software to read data from a `.s2d` file, see [Visualizing Mixer Spurs](#).

`h = read(h,filename)` updates `h` with data from the specified file. In this syntax, `h` can be a circuit or data object. `filename` is a string, representing the filename of a `.snp`, `.ynp`, `.znp`, `.hnp`, `.gnp`, or `.amp` file. If `h` is an `rfckt.amplifier`, `rfckt.mixer`, or `rfdata.data` object, `filename` can also represent a `.p2d` or `.s2d` file. For all files, the filename must include the file extension.

`h = read(rfckt.datafile,filename)` creates an `rfckt.datafile` object `h`, reads the RF data from the specified file, and stores it in `h`.

`h = read(rfckt.passive,filename)` creates an `rfckt.passive` object `h`, reads the RF data from the specified file, and stores it in `h`.

`h = read(rfckt.amplifier,filename)` creates an `rfckt.amplifier` object `h`, reads the RF data from the specified file, and stores it in `h`.

`h = read(rfckt.mixer,filename)` creates an `rfckt.mixer` object `h`, reads the RF data from the specified file, and stores it in `h`.

`h = read(rfdata.data,filename)` creates an `rfdata.data` object `h`, reads the RF data from the specified file, and stores it in `h`.

**Examples**

The following example shows you how to import data from the file `default.amp` into an `rfckt.amplifier` object.

```
ckt_obj=read(rfckt.amplifier, 'default.amp');
```

**References**

EIA/IBIS Open Forum, “Touchstone File Format Specification,” Rev. 1.1, 2002  
([http://www.vhdl.org/pub/ibis/connector/touchstone\\_spec11.pdf](http://www.vhdl.org/pub/ibis/connector/touchstone_spec11.pdf)).

**See Also**

`analyze` | `calculate` | `extract` | `getz0` | `listformat` | `listparam` |  
`loglog` | `plot` | `plotyy` | `polar` | `restore` | `semilogx` | `semilogy` |  
`smith` | `write`

# report

---

<b>Purpose</b>	Summarize mixer configurations and spur-free-zone information for a multiband transmitter or receiver
<b>Syntax</b>	<code>report(hif)</code>
<b>Description</b>	<p><code>report(hif)</code> displays a summary at the command line of the information contained in the <code>OpenIF</code> object <code>hif</code>. The summary contains:</p> <ul style="list-style-type: none"><li>• The IF location.</li><li>• The properties of each mixer, including the RF center frequencies, bandwidths, mixing types, and intermodulation tables.</li><li>• The spur-free zones.</li></ul> <p>Each spur-free zone is a range of IF center frequencies. An IF signal centered in this range does not generate interference in any transmission or reception bands.</p>
<b>Input Arguments</b>	<p><b>hif</b> <code>OpenIF</code> object</p>
<b>Alternatives</b>	<ul style="list-style-type: none"><li>• The <code>getSpurFreeZoneData</code> returns the endpoints of the spur-free zones in a matrix.</li><li>• The <code>show</code> method generates an interactive spur graph that shows spurious regions and spur-free zones.</li></ul>
<b>Examples</b>	For an IF-planning example using an <code>OpenIF</code> object, see the “Examples” on page 7-6 section of the <code>OpenIF</code> class reference page.
<b>See Also</b>	<code>addMixer</code>   <code>getSpurData</code>   <code>getSpurFreeZoneData</code>   <code>show</code>   <code>OpenIF</code>



**Purpose** Restore data to original frequencies

**Syntax** `h = restore(h)`

**Description** `h = restore(h)` restores data in `h` to the original frequencies of `NetworkData` for plotting. Here, `h` can be `rfckt.datafile`, `rfckt.passive`, `rfckt.amplifier`, or `rfckt.mixer`.

**See Also** `analyze` | `calculate` | `extract` | `getz0` | `listformat` | `listparam` | `loglog` | `plot` | `plotyy` | `polar` | `semilogx` | `semilogy` | `smith` | `read` | `write`

## Purpose

Plot specified circuit object parameters using log scale for  $x$ -axis

## Syntax

```
lineseries = semilogx(h,parameter)
lineseries = semilogx(h,parameter1,...,parametern)
lineseries = semilogx(h,parameter1,...,parametern,format)
lineseries = semilogx(h,'parameter1',...,'parametern', format,
    xparameter,xformat,'condition1',value1,..., 'conditionm',
    valuem, 'freq',freq,'pin',pin)
```

## Description

`lineseries = semilogx(h,parameter)` plots the specified parameter in the default format using a logarithmic scale for the  $x$ -axis. `h` is the handle of a circuit (`rfckt`) object.

Type `listparam(h)` to get a list of valid parameters for a circuit object, `h`. Type `listformat(h,parameter)` to see the legitimate formats for a specified parameter. The first listed format is the default for the specified parameter.

The `semilogx` method returns a column vector of handles to `lineseries` objects, one handle per line. This output is the same as the output returned by the MATLAB `semilogx` function.

`lineseries = semilogx(h,parameter1,...,parametern)` plots the parameters `parameter1,..., parametern` from the object `h` on an X-Y plane using a logarithmic scale for the  $x$ -axis.

`lineseries = semilogx(h,parameter1,...,parametern,format)` plots the parameters `parameter1,..., parametern` in the specified format. `format` is the format of the data to be plotted, e.g. 'Magnitude (decibels)'.

---

**Note** For all circuit objects except those that contain data from a data file, you must perform a frequency domain analysis with the `analyze` method before calling `semilogx`.

---

Use the Property Editor (`propertyeditor`) or the MATLAB `set` function to change `lineseries` properties. The reference pages for

MATLAB functions such as `figure`, `axes`, and `text` also list available properties and provide links to more complete property descriptions.

---

**Note** Use the MATLAB `semilogx` function to create a semi-log scale plot of network parameters that are specified as vector data and are not part of a circuit (`rfckt`) object or data (`rfdata`) object.

---

`lineseries = semilogx(h, 'parameter1', ..., 'parameterN', format, xparameter, xformat, 'condition1', value1, ..., 'conditionM', valueM, 'freq', freq, 'pin', pin)` plots the specified parameters at the specified operating conditions for the object `h`.

`xparameter` is the independent variable to use in plotting the specified parameters. Several `xparameter` values are available for all objects. When you import `rfckt.amplifier`, `rfckt.mixer`, or `rfdata.data` object specifications from a `.p2d` or `.s2d` file, you can also specify any operating conditions from the file that have numeric values, such as bias.

The following table shows the most commonly available parameters and the corresponding `xparameter` values. The default settings listed in the table are used if `xparameter` is not specified.

Parameter Name	xparameter values
Pout, Phase, LS11, LS12, LS21, LS22	Pin (default), Freq
S11, S12, S21, S22, NF, IIP3, OIP3, GroupDelay, VSWRIn, VSWROut, GammaIn, GammaOut, FMIN, GammaOPT, RN, TF1, TF2, Gt, Ga, Gp, Gmag, Gmsg, GammaMS, GammaML, K, Delta, Mu, MuPrime	Freq
AM/AM, AM/PM	AM

xformat is the format to use for the specified xparameter. No xformat specification is needed when xparameter is an operating condition.

The following table shows the xformat values that are available for the xparameter values listed in the preceding table, along with the default settings that are used if xformat is not specified.

xparameter values	xformat values
Pin	dBm (default), mW, W, dBW
Freq	THz, GHz, MHz, KHz, Hz By default, xformat is chosen to provide the best scaling for the given xparameter values.
AM	Magnitude (decibels) (default), Magnitude (linear)

condition1,value1,..., conditionm,valuem are the optional condition/value pairs at which to plot the specified parameters. These pairs are usually operating conditions from a .p2d or .s2d file. For some parameters, you can specify a set of frequency or input power values at which to plot the specified parameter.

For example:

- When plotting large-signal S-parameters as a function of input power, you can specify frequency points of interest using condition/value pairs.
- When plotting large-signal S-parameters as a function of frequency, you can specify input power levels of interest using condition/value pairs.
- When plotting parameters as a function of an operating condition, you can specify both frequency and input power values using condition/value pairs.

freq is the optional frequency value, in hertz, at which to plot the specified parameters.

`pin` is the optional input power value, in dBm, at which to plot the specified parameters.

If `h` has multiple operating conditions, such as from a `.p2d` or `.s2d` file, the `semilogx` method operates as follows:

- If you do not specify any operating conditions as arguments to the `semilogx` method, then the method plots the parameter values based on the currently selected operating condition.
- If you specify one or more operating conditions, the `semilogx` method plots the parameter values based on those operating conditions.
- When you use an operating condition for the `xparameter` input argument, the method plots the parameters for all operating condition values.

## See Also

`analyze` | `calculate` | `extract` | `getz0` | `listformat` | `listparam`  
| `loglog` | `plot` | `plotyy` | `polar` | `read` | `restore` | `semilogy` |  
`smith` | `write`

## Purpose

Plot specified circuit object parameters using log scale for  $x$ -axis

## Syntax

```
lineseries = semilogy(h,parameter)
lineseries = semilogy(h,parameter1,...,parametern)
lineseries = semilogy(h,parameter1,...,parametern,format)
lineseries = semilogy(h,'parameter1',...,'parametern', format,
    xparameter,xformat,'condition1',value1,..., 'conditionm',
    valuem, 'freq',freq,'pin',pin)
```

## Description

`lineseries = semilogy(h,parameter)` plots the specified parameter in the default format using a logarithmic scale for the  $y$ -axis. `h` is the handle of a circuit (`rfckt`) object.

Type `listparam(h)` to get a list of valid parameters for a circuit object, `h`. Type `listformat(h,parameter)` to see the legitimate formats for a specified parameter. The first listed format is the default for the specified parameter.

The `semilogy` method returns a column vector of handles to `lineseries` objects, one handle per line. This output is the same as the output returned by the MATLAB `semilogy` function.

`lineseries = semilogy(h,parameter1,...,parametern)` plots the parameters `parameter1,..., parametern` from the object `h` on an X-Y plane using a logarithmic scale for the  $y$ -axis.

`lineseries = semilogy(h,parameter1,...,parametern,format)` plots the parameters `parameter1,..., parametern` in the specified format. `format` is the format of the data to be plotted, e.g. `'Magnitude (decibels)'`.

---

**Note** For all circuit objects except those that contain data from a data file, you must perform a frequency domain analysis with the `analyze` method before calling `semilogy`.

---

Use the Property Editor (`propertyeditor`) or the MATLAB `set` function to change `lineseries` properties. The reference pages for

MATLAB functions such as `figure`, `axes`, and `text` also list available properties and provide links to more complete property descriptions.

---

**Note** Use the MATLAB `semilogy` function to create a semi-log scale plot of parameters that are specified as vector data and are not part of a circuit (`rfckt`) object or data (`rfddata`) object.

---

`lineseries = semilogy(h, 'parameter1', ..., 'parameterN', format, xparameter, xformat, 'condition1', value1, ..., 'conditionM', valueM, 'freq', freq, 'pin', pin)` plots the specified parameters at the specified operating conditions for the object `h`.

`xparameter` is the independent variable to use in plotting the specified parameters. Several `xparameter` values are available for all objects. When you import `rfckt.amplifier`, `rfckt.mixer`, or `rfddata.data` object specifications from a `.p2d` or `.s2d` file, you can also specify any operating conditions from the file that have numeric values, such as `bias`.

The following table shows the most commonly available parameters and the corresponding `xparameter` values. The default settings listed in the table are used if `xparameter` is not specified.

Parameter Name	xparameter values
Pout, Phase, LS11, LS12, LS21, LS22	Pin (default), Freq
S11, S12, S21, S22, NF, IIP3, OIP3, GroupDelay, VSWRIn, VSWROut, GammaIn, GammaOut, FMIN, GammaOPT, RN, TF1, TF2, Gt, Ga, Gp, Gmag, Gmsg, GammaMS, GammaML, K, Delta, Mu, MuPrime	Freq
AM/AM, AM/PM	AM

`xformat` is the format to use for the specified `xparameter`. No `xformat` specification is needed when `xparameter` is an operating condition.

The following table shows the `xformat` values that are available for the `xparameter` values listed in the preceding table, along with the default settings that are used if `xformat` is not specified.

<b>xparameter values</b>	<b>xformat values</b>
Pin	dBm (default), mW, W, dBW
Freq	THz, GHz, MHz, KHz, Hz By default, <code>xformat</code> is chosen to provide the best scaling for the given <code>xparameter</code> values.
AM	Magnitude (decibels) (default), Magnitude (linear)

`condition1,value1,...,conditionm,valuem` are the optional condition/value pairs at which to plot the specified parameters. These pairs are usually operating conditions from a `.p2d` or `.s2d` file. For some parameters, you can specify a set of frequency or input power values at which to plot the specified parameter.

For example:

- When plotting large-signal S-parameters as a function of input power, you can specify frequency points of interest using condition/value pairs.
- When plotting large-signal S-parameters as a function of frequency, you can specify input power levels of interest using condition/value pairs.
- When plotting parameters as a function of an operating condition, you can specify both frequency and input power values using condition/value pairs.

`freq` is the optional frequency value, in hertz, at which to plot the specified parameters.



`pin` is the optional input power value, in dBm, at which to plot the specified parameters.

If `h` has multiple operating conditions, such as from a `.p2d` or `.s2d` file, the `semilogy` method operates as follows:

- If you do not specify any operating conditions as arguments to the `semilogy` method, then the method plots the parameter values based on the currently selected operating condition.
- If you specify one or more operating conditions, the `semilogy` method plots the parameter values based on those operating conditions.
- When you use an operating condition for the `xparameter` input argument, the method plots the parameters for all operating condition values.

## See Also

`analyze` | `calculate` | `extract` | `getz0` | `listformat` | `listparam`  
| `loglog` | `plot` | `plotyy` | `polar` | `read` | `restore` | `semilogx` |  
`smith` | `write`

# setop

---

## Purpose

Set operating conditions

## Syntax

```
setop(h)
setop(h, 'Condition1')
setop(h, 'Condition1', value1, 'Condition2', value2, ...)
```

## Description

`setop(h)` lists the available values for all operating conditions of the object `h`. Operating conditions only apply to objects you import from a `.p2d` or `.s2d` file. To import these types of data into an object, use the `read` method. Operating conditions are not listed with other properties of an object.

`setop(h, 'Condition1')` lists the available values for the specified operating condition `'Condition1'`.

`setop(h, 'Condition1', value1, 'Condition2', value2, ...)` changes the operating conditions of the circuit or data object, `h`, to those specified by the condition/value pairs. Conditions you do not specify retain their original values. The method ignores any conditions that are not applicable to the specified object. Ignoring these conditions lets you apply the same set of operating conditions to an entire network where different conditions exist for different components.

When you set the operating conditions for a network that contains several objects, the software does not issue an error or warning if the specified conditions cannot be applied to all objects. For some networks, this lack of error or warning lets you call the `setop` method once to apply the same set of operating conditions to any objects where operating conditions are applicable. However, you may want to specify a network that contains one or more of the following:

- Several objects with different sets of operating conditions.
- Several objects with the same set of operating conditions that are configured differently.

To specify operating conditions one of these types of networks, use a separate call to the `setop` method for each object.

**Examples**

List the possible operating conditions of an object:

```
ckt1 = read(rfckt.amplifier, 'default.p2d');  
setop(ckt1)
```

Analyze an object under specific operating conditions:

```
ckt1 = read(rfckt.amplifier, 'default.p2d');  
freq = ckt1.AnalyzedResult.Freq;  
setop(ckt1, 'Bias', '1.5');  
result1 = analyze(ckt1, freq)
```

**See Also**

getop

# show

## Purpose

Produce a spur graph for a multiband transmitter or receiver

## Syntax

`show(hif)`

## Description

`show(hif)` produces a spur graph of the OpenIF object `hif`. The spur graph contains:

- Vertical green bands, representing spur-free zones.
- Horizontal colored bands, representing spurious regions.

The following figure shows a spur graph for the three-mixer multiband receiver example on the OpenIF class reference page.

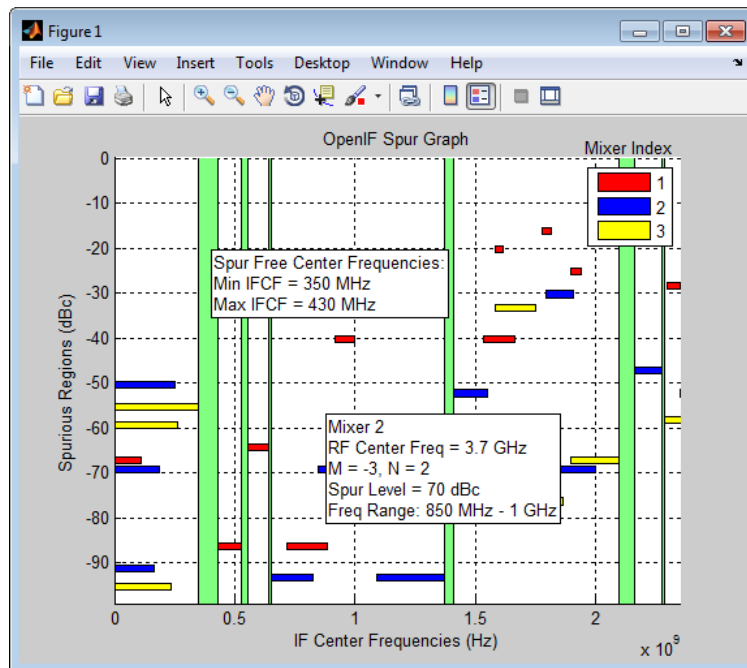

Spur-free zones are ranges of possible IF center frequencies that are free from intermodulation distortion. Depending on the configuration of the mixers in `hif`, spur-free zones may not appear. Clicking on a

spur-free zone produces a tooltip, which displays information about the spur-free zone:

- **Min IFCF** — The minimum possible IF center frequency  $f_{IF}$  for the corresponding spur-free zone.
- **Max IFCF** — The maximum possible IF center frequency  $f_{IF}$  for the corresponding spur-free zone.

Spurious regions contain intermodulation products from at least one mixer. The color of a spur on the spur graph indicates which mixer generates the spur, according to the legend on the spur graph. Clicking on a spurious region produces a tooltip, which displays information about the spur:

- **RF Center Freq** — the RF center frequency  $f_{RF}$  of the mixer that generates the spur
- **M, N** — the coefficients in the equation  $|Mf_{RF} - N(f_{RF} \pm f_{IF})|$  (down-conversion) or the equation  $|Mf_{IF} + N(f_{RF} \pm f_{IF})|$ . The sign of ‘ $\pm$ ’ in these equations is determined by the injection type of the mixer. These coefficients refer to the particular mixing product that generates the spurious region.
- **Spur Level** — The difference in magnitude between a signal at 0 dBc and the spur. If you set `hif.SpurLevel` to a number greater than this value, then `hif` does not report the region as spurious.
- **Freq Range** — The frequency range of the spurious region. Choosing an IF center frequency in this range causes interference with the intermodulation product corresponding to the spur.

## Input Arguments

**hif**  
OpenIF object

## Alternatives

- The `getSpurFreeZoneData` returns the endpoints of the spur-free zones in a matrix.
- The `report` method displays mixer configurations, intermodulation tables, and spur-free zone information at the command line.

# show

---

## Examples

- The `OpenIF` class reference page contains an example that shows how to find the spur-free zones of a multiband receiver with three mixers.
- The example `Finding Free IF Bandwidths` shows how to use information from a spur graph to design a multiband receiver with spur-free zones.

## See Also

`addMixer` | `getSpurData` | `getSpurFreeZoneData` | `report` | `OpenIF`

**Purpose**

Plot specified circuit object parameters on Smith chart

**Syntax**

```
smith(hnet,i,j)
hsm = smith(hnet,i,j)
[lineseries,hsm] = smith(h,parameter1,...,parametern,type)
[lineseries,hsm] = smith(h,'parameter1',...,'parametern', type,
    xparameter,xformat,'condition1',value1,..., 'conditionm',
    valuem, 'freq',freq,'pin',pin)
```

**Description**

`smith(hnet,i,j)` plots the  $(i,j)$ th parameter of `hnet` on a Smith Chart. `hnet` is an RF Toolbox network parameter object. The inputs `i` and `j` are positive integers whose value is less than or equal to 2 for hybrid and hybrid-g parameter objects, or less than or equal to `hnet.NumPorts` for ABCD, S-, Y-, or Z-parameter objects.

`hsm = smith(hnet,i,j)` returns the handle of the figure used to create the plot, `hsm`.

`[lineseries,hsm] = smith(h,parameter1,...,parametern,type)` plots the network parameters `parameter1,..., parametern` from the object `h` on a Smith chart. `h` is the handle of a circuit (`rfckt`) or data (`rfddata`) object that contains  $n$ -port network parameter data. `type` is a string that specifies the type of Smith chart:

- 'z' (default)
- 'y'
- 'zy'

Type `listparam(h)` to get a list of valid parameters for a circuit object `h`.

---

**Note** For all circuit objects except those that contain data from a data file, you must use the `analyze` method to perform a frequency domain analysis before calling `smith`.

---

```
[lineseries,hsm] = smith(h,'parameter1',...,'parameterN',
type,xparameter,xformat,'condition1',value1,...,
'conditionM',valuem, 'freq',freq,'pin',pin) plots the specified
parameters at the specified operating conditions for the object h.
```

xparameter is the independent variable to use in plotting the specified parameters. Several xparameter values are available for all objects. When you import 2-port rfckt.amplifier, rfckt.mixer, or rfdata.data object specifications from a .p2d or .s2d file, you can also specify any operating conditions from the file that have numeric values, such as bias.

The following table shows the most commonly available parameters and the corresponding xparameter values. The default settings listed in the table are used if xparameter is not specified.

Parameter Name	xparameter values
Pout, Phase, LS11, LS12, LS21, LS22	Pin (default), Freq
S11, S12, S21, S22, NF, IIP3, OIP3, VSWRIn, VSWROut, GammaIn, GammaOut, FMIN, GammaOPT, RN	Freq
AM/AM, AM/PM	AM

xformat is the format to use for the specified xparameter. No xformat specification is needed when xparameter is an operating condition.

The following table shows the xformat values that are available for the xparameter values listed in the preceding table, along with the default settings that are used if xformat is not specified.



xparameter values	xformat values
Pin	dBm (default), mW, W, dBW
Freq	THz, GHz, MHz, KHz, Hz By default, xformat is chosen to provide the best scaling for the given xparameter values.
AM	Magnitude (decibels) (default), Magnitude (linear)

condition1,value1,..., conditionm,valuem are the optional condition/value pairs at which to plot the specified parameters. These pairs are usually operating conditions from a .p2d or .s2d file. For some parameters, you can specify a set of frequency or input power values at which to plot the specified parameter.

For example:

- When plotting large-signal S-parameters as a function of input power, you can specify frequency points of interest using condition/value pairs.
- When plotting large-signal S-parameters as a function of frequency, you can specify input power levels of interest using condition/value pairs.
- When plotting parameters as a function of an operating condition, you can specify both frequency and input power values using condition/value pairs.

freq is the optional frequency value, in hertz, at which to plot the specified parameters.

pin is the optional input power value, in dBm, at which to plot the specified parameters.

If h has multiple operating conditions, such as from a .p2d or .s2d file, the smith method operates as follows:

- If you do not specify any operating conditions as arguments to the `smith` method, then the method plots the parameter values based on the currently selected operating condition.
- If you specify one or more operating conditions, the `smith` method plots the parameter values based on those operating conditions.
- When you use an operating condition for the `xparameter` input argument, the method plots the parameters for all operating condition values.

---

**Note** Use the `smithchart` function to plot network parameters that are not part of a circuit (`rfckt`) or data (`rfddata`) object, but are specified as vector data.

---

## Changing Properties of the Plotted Lines

The `smith` method returns `lineseries`, a column vector of handles to `lineseries` objects, one handle per plotted line. Use the MATLAB `lineseries properties` function to change the properties of these lines.

## Changing Properties of the Smith Chart

The `smith` method returns the handle `hsm` of the Smith chart. Use the properties listed below to change the properties of the chart itself.

## Properties

`smith` creates the plot using the default property values of a Smith chart. Use `set(hsm, 'PropertyName1', PropertyValue1, ...)` to change the property values of the chart. Use `get(hsm)` to get the property values.

This table lists all properties you can specify for a Smith chart object along with units, valid values, and a descriptions of their use.

Property Name	Description	Units, Values
Color	Line color for a Z or Y Smith chart. For a ZY Smith chart, the Z line color.	ColorSpec. Default is [0.4 0.4 0.4] (dark gray).
LabelColor	Color of the line labels.	ColorSpec. Default is [0 0 0] (black).
LabelSize	Size of the line labels.	FontSize. Default is 10. See the Annotation Textbox Properties reference page for more information on specifying font size.
LabelVisible	Visibility of the line labels.	'on' (default) or 'off'
LineType	Line spec for a Z or Y Smith chart. For a ZY Smith chart, the Z line spec.	LineStyle. Default is '-' (solid line).
LineWidth	Line width for a Z or Y Smith chart. For a ZY Smith chart, the Z line width.	Number of points. Default is 0.5.
SubColor	The Y line color for a ZY Smith chart.	ColorSpec. Default is [0.8 0.8 0.8] (medium gray).
SubLineType	The Y line spec for a ZY Smith chart.	LineStyle. Default is ':' (dotted line).
SubLineWidth	The Y line width for a ZY Smith chart.	Number of points. Default is 0.5.

# smith

---

Property Name	Description	Units, Values
Type	Type of Smith chart.	'z' (default), 'y', or 'zy'
Value	Two-row matrix. Row 1 specifies the values of the constant resistance and reactance lines that appear on the chart. For the constant resistance/reactance lines, each element in Row 2 specifies the value of the constant reactance/resistance line at which the corresponding line specified in Row 1 ends.	2-by-n matrix. Default is [0.2000 0.5000 1.0000 2.0000 5.0000; 1.0000 2.0000 5.0000 5.0000 30.0000]

## See Also

analyze | calculate | circle | getz0 | listformat | listparam  
| loglog | plot | plotyy | polar | read | restore | semilogx |  
semilogy | write

**Purpose** Step-signal response of model object

**Syntax** [yout,tout] = stepresp(h, ts, n, trise)

**Description** [yout,tout] = stepresp(h, ts, n, trise) calculates the time-domain response of a rational function object, h, to a step signal, defined as:

$$\begin{cases} U(kt_s) = kt_s / t_{rise}, & 0 \leq k < (t_{rise} / t_s) \\ U(kt_s) = 1, & (t_{rise} / t_s) \leq k \leq N \end{cases}$$

The variable  $t_s$  is the sample time, ts;  $N$  is the number of samples, n; and  $t_{rise}$  is the time, trise, that it takes for the step signal to reach its maximum value. The variable  $k$  is an integer between 0 and  $N$ , referring to the index of the samples.

The following figure illustrates the construction of this signal.

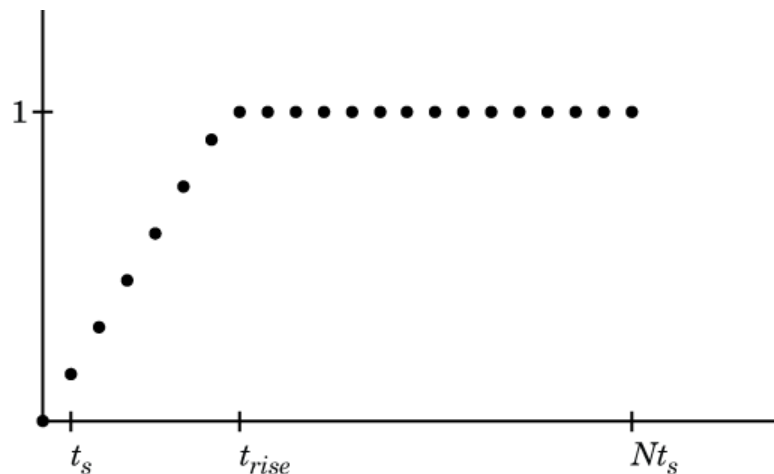

The output yout is the response of the step signal at time tout.

## Examples

Calculate the step response of a rational function object:

```
% Read a .S2P data file
h = read(rfckt.passive, 'passive.s2p')
% Get the S11 parameters
S11 = h.AnalyzedResult.S_Parameters(1,1,:);
Freq = h.AnalyzedResult.Freq;
% Fit S11 to a rational function object
RationalModelS11 = rationalfit(Freq, S11);
% Define parameters for a step signal
Ts = 1.0e-11; N = 10000; Trise = 1.0e-10;
% Calculate the step response for TDR and plot it
[TDR, Time1] = stepresp(RationalModelS11, Ts, N, Trise);
figure(1)
plot(Time1*1e9, TDR);
ylabel('TDR'); xlabel('Time (ns)');
% Calculate TDT and plot it
S21 = h.AnalyzedResult.S_Parameters(2,1,:);
RationalModelS21 = rationalfit(Freq, S21);
[TDT, Time2] = stepresp(RationalModelS21, Ts, N, Trise);
figure(2)
plot(Time2*1e9, TDT);
ylabel('TDT'); xlabel('Time (ns)');
```

## See Also

freqresp | rationalfit | timeresp

## How To

- rfmodel.rational

**Purpose**

Display specified RF object parameters in Variable Editor

**Syntax**

```
table(h,param1,format1,...,paramn,formatn)
table(h,'budget',param1,format1,...,paramn,formatn)
```

**Description**

`table(h,param1,format1,...,paramn,formatn)` displays the specified parameters *param1* through *paramn*, with units *format1* through *formatn*, in the Variable Editor. The input *h* is a function handle to an `rfckt` object.

The method creates a structure in the MATLAB workspace and constructs the name of the structure from the names of the object and parameters you provide. Specify parameters and formats in pairs. If you do not specify a format, the method uses the default format for that parameter.

To list valid parameters and parameter formats for *h*, use the `listparam` and `listformat` methods.

`table(h,'budget',param1,format1,...,paramn,formatn)` specified budget parameters of an `rfckt.cascade` object *h*.

**Examples**

Analyze an RF cascade and display the link budget in a table:

```
% Construct a cascaded RFCKT object
Cascaded_Ckt = rfckt.cascade('Ckts', ...
    {rfckt.txline('LineLength', .001), ...
    rfckt.amplifier, rfckt.txline( ...
    'LineLength', 0.025, 'PV', 2.0e8)})
% Do frequency domain analysis at the given frequency
freq = 2.1e9;
analyze(Cascaded_Ckt,freq);
% Plot the Budget S21 and NF
plot(Cascaded_Ckt, 'budget', 'S21', 'NF');
% Display the Budget S21 and NF in a table
table(Cascaded_Ckt, 'budget', 'S21', 'NF');
```

**See Also**

`openvar` | `plot`

# timeresp

---

**Purpose** Time response for model object

**Syntax** `[y,t] = timeresp(h,u,ts)`

**Description** `[y,t] = timeresp(h,u,ts)` computes the output signal, *y*, that the `rfmodel` object, *h*, produces in response to the given input signal, *u*.

The input *h* is the handle of a model object. *ts* is a positive scalar value that specifies the sample time of the input signal.

The output *y* is the output signal. RF Toolbox software computes the value of the signal at the time samples in the vector *t* using the following equation.

$$Y(n) = \text{sum}(C.*X(n - \text{Delay}/ts)) + D*U(n - \text{Delay}/ts)$$

where

$$X(n+1) = F*X(n) + G*U(n)$$

$$X(1) = 0$$

$$F = \exp(A*ts)$$

$$G = (F - 1) ./ A$$

and *A*, *C*, *D*, and *Delay* are properties of the `rfmodel.rational` object, *h*.

## Examples

The following example shows you how to compute the time response of the data stored in the file `default.s2p` by fitting a rational function model to the data and using the `timeresp` method to compute the time response of the model.

```
% Define the input signal
SampleTime = 2e-11;
OverSamplingFactor = 25;
TotalSampleNumber = 2^12;
InputTime = double((1:TotalSampleNumber)')*SampleTime;
InputSignal = sign(randn(1, ...
    ceil(TotalSampleNumber/OverSamplingFactor)));
InputSignal = repmat(InputSignal, [OverSamplingFactor, 1]);
```



```
InputSignal = InputSignal(:);

% Create a rational function model
orig_data=read(rfdata.data,'default.s2p');
freq=orig_data.Freq;
data=orig_data.S_Parameters(2,1,:);
fit_data=rationalfit(freq,data);

% Compute the time response
[y,t]=timeresp(fit_data,InputSignal,SampleTime);
```

**See Also**

freqresp | rationalfit | writeva

**How To**

- rfmodel.rational

# write

---

**Purpose** Write RF data from circuit or data object to file

**Syntax** `status = write(data, filename, dataformat, funit, printformat, freqformat)`

**Description** `status = write(data, filename, dataformat, funit, printformat, freqformat)` writes information from `data` to the specified file. `data` is a circuit object or `rfdata.data` object that contains sufficient information to write the specified file. `filename` is a string representing the filename of a `.snp`, `.ynp`, `.znp`, `.hnp`, or `.amp` file, where `n` is the number of ports. The default filename extension is `.snp`. `write` returns `True` if the operation is successful and returns `False` otherwise.

`dataformat` specifies the format of the data to be written. It must be one of the case-insensitive strings in the following table.

Format	Description
'DB'	Data is given in (dB-magnitude, angle) pairs with angle in degrees.
'MA'	Data is given in (magnitude, angle) pairs with angle in degrees.
'RI'	Data is given in (real, imaginary) pairs (default).

`funit` specifies the frequency units of the data to be written. It must be `'GHz'`, `'MHz'`, `'KHz'`, or `'Hz'`. If you do not specify `funit`, its value is taken from the object `data`. All values are case-insensitive.

The `printformat` string that specifies the precision of the network and noise parameters. The default value is `%22.10f`. This value means the method writes the data using fixed-point notation with a precision of 10 digits. The minimum positive value the `write` method can express by default is `1e-10`. For greater precision, specify a different `printformat`. See the Format String specification for `fprintf`.

The `freqformat` string that specifies the precision of the frequency. The default value is `%-22.10f`. See the Format String specification for `fprintf`.

---

**Note** The method only writes property values from data that the specified output file supports. For example, Touchstone files, which have the `.snp`, `.ynp`, `.znp`, or `.hnp` extension, do not support noise figure or output third-order intercept point. Consequently, the `write` method does not write these property values to these such files.

---

## Examples

The following example shows you how to analyze the data stored in the file `default.s2p` for a different set of frequency values, and use the `write` method to store the results in a file called `test.s2p`.

```
orig_data=read(rfdata.data,'default.s2p')
freq=[1:.1:2]*1e9;
analyze(orig_data,freq);
write(orig_data,'test.s2p');
```

## References

EIA/IBIS Open Forum, “Touchstone File Format Specification,” Rev. 1.1, 2002 ([http://www.vhdl.org/pub/ibis/connector/touchstone\\_spec11.pdf](http://www.vhdl.org/pub/ibis/connector/touchstone_spec11.pdf)).

## See Also

`analyze` | `calculate` | `extract` | `getz0` | `listformat` | `listparam` | `loglog` | `plot` | `plotyy` | `polar` | `semilogx` | `semilogy` | `smith` | `read` | `restore`

**Purpose** Write Verilog-A description of RF model object

**Syntax** `status = writeva(h,filename,innets,outnets, ...  
printformat,discipline,filestoinclude)`

**Description** `status = writeva(h,filename,innets,outnets,printformat, discipline,filestoinclude)` writes a Verilog-A module that describes an `rfmodel` object `h` to the file specified by `filename`. The method implements the object in Verilog-A using Laplace Transform S-domain filters. It returns a `status` of `True`, if the operation is successful, and `False` if it is unsuccessful.

`h` is the handle to the `rfmodel.rational` object. Typically, the `rationalfit` function creates this object when you fit a rational function to a set of data.

`filename` is a string representing the name of the Verilog-A file to which to write the module. The `filename` can be specified with or without a path name and extension. The default extension, `.va`, is added automatically if `filename` does not end in this extension. The module name that is used in the file is the part of the `filename` that remains when the path name and extension are removed.

`innets` is a string or a cell of two strings that specifies the name of each of the module's input nets. The default is `'in'`.

`outnets` is a string or a cell of two strings that specifies the name of each of the module's output nets. The default is `'out'`.

`printformat` is a string that specifies the precision of the following Verilog-A module parameters using the C language conversion specifications:

- The numerator and denominator coefficients of the Verilog-A filter.
- The module's delay value and constant offset (or direct feedthrough), which are taken directly from the `rfmodel` object.

The default is `'%15.10e'`. For more information on how to specify `printformat`, see the Format String specification for `fprintf`.

`discipline` is a string that specifies the predefined Verilog-A discipline of the nets. The discipline defines attributes and characteristics associated with the nets. The default is `'electrical'`.

`filestoinclude` is a cell of strings that specifies a list of header files to include in the module using Verilog-A `'`include'` statements. By default, `filestoinclude` is set to `'`include discipline.vams'`.

For more information on Verilog-A, see the Verilog-A Reference Manual.

**See Also**

`freqresp` | `rationalfit` | `timeresp`

**How To**

- `rfmodel.rational`

# newref

---

**Purpose** Change reference impedance of S-parameters

**Syntax** `hs2 = newref (hs,Z0)`

**Description** `hs2 = newref (hs,Z0)` creates an S-parameter object, `hs2`, by converting the S-parameters in `hs` to the specified reference impedance, `Z0`.

**Input Arguments** **hs - S-parameters**  
network parameter object

S-parameters, specified as an RF Toolbox network parameter object. To create this type of object, use the `sparameters` function.

**Z0 - Reference impedance**  
real positive scalar

Characteristic impedance, in ohms, specified as a real positive scalar.

**Output Arguments** **hs2 - S-parameters**  
network parameter object

S-parameters with reference impedance `Z0`, returned as an RF Toolbox network parameter object.

**Examples** **Change reference impedance of S-parameters**

Create an S-parameters object from data in the file, `default.s2p`.

```
hs = sparameters('default.s2p');
```

Change the reference impedance to 40 ohms.

```
hs2 = newref (hs,40);
```

**See Also** `sparameters`

<b>Purpose</b>	Interpolate network parameter data
<b>Syntax</b>	<code>hnet2 = rfinterp1(hnet,freq)</code>
<b>Description</b>	<code>hnet2 = rfinterp1(hnet,freq)</code> interpolates the network parameter data in <code>hnet</code> at the specified frequencies, <code>freq</code> , storing the results in <code>hnet2</code> .
<b>Input Arguments</b>	<p><b>hnet - Original data</b> network parameter object</p> <p>Data to interpolate, specified as an RF Toolbox network parameter object.</p> <p><b>freq - Frequencies</b> vector of positive numbers</p> <p>Frequencies of interpolation, specified as a vector of positive numbers ordered from smallest to largest.</p>
<b>Output Arguments</b>	<p><b>hnet2 - Interpolated data</b> network parameter object</p> <p>Result of interpolation, returned as an RF Toolbox network parameter object of the same type as <code>hnet</code>.</p>
<b>Algorithms</b>	<p>The function uses the MATLAB function <code>interp1</code> to perform the interpolation operation. Overall performance is similar to the RF Toolbox <code>analyze</code> function. However, behaviors of the two functions differ when <code>freq</code> contains frequencies outside the range of the original data:</p> <ul style="list-style-type: none"> <li>• <code>analyze</code> performs a zeroth-order extrapolation for out-of-range data points.</li> <li>• <code>rfinterp1</code> inserts NaN values for out-of-range data points.</li> </ul>

# rfinterp1

---

## Examples

### Interpolate S-parameter data

Read the data from the file `default.s2p` into an S-parameter object.

```
hnet = sparameters('default.s2p');
```

Interpolate the data at a specified set of frequencies.

```
freq = [1.2:0.2:2.8]*1e9;  
hnet2 = rfinterp1(hnet,freq);
```

## See Also

`analyze` | `interp1`



<b>Purpose</b>	Extract vector of network parameters
<b>Syntax</b>	<pre>n_ij = rfparam(hnet,i,j) abcd_vector = rfparam(habcd,abcdflag)</pre>
<b>Description</b>	<p><code>n_ij = rfparam(hnet,i,j)</code> extracts the network parameter vector (<i>i,j</i>) from the network parameter object, <code>hnet</code>.</p> <p><code>abcd_vector = rfparam(habcd,abcdflag)</code> extracts the <i>A</i>, <i>B</i>, <i>C</i>, or <i>D</i> vector from ABCD-parameter object, <code>habcd</code>.</p>
<b>Input Arguments</b>	<p><b>abcdflag - ABCD-parameter index</b> 'A'   'B'   'C'   'D'</p> <p>Flag that determines which ABCD parameters the function extracts, specified as 'A', 'B', 'C', or 'D'.</p> <p><b>habcd - 2-port ABCD parameters</b> ABCD parameter object</p> <p>2-port ABCD parameters, specified as an RF Toolbox ABCD parameter object. When you specify <code>abcdflag</code>, you must also specify an ABCD parameter object.</p> <p><b>hnet - Network parameters</b> network parameter object</p> <p>Network parameters, specified as an RF Toolbox network parameter object.</p> <p><b>i - Row index</b> positive integer</p> <p>Row index of data to extract, specified as a positive integer.</p> <p><b>j - Column index</b> positive integer</p>

## Output Arguments

Column index of data to extract, specified as a positive integer.

### **n\_ij - Network parameters (*i,j*)**

vector

Network parameters (*i,j*), returned as a vector. The *i* and *j* input arguments determine which parameters the function returns.

**Example:** `S_21 = rfparam(hs,2,1)`

### **abcd\_vector - A, B, C, or D-parameters**

vector

*A*, *B*, *C*, or *D*-parameters, returned as a vector. The `abcdflag` input argument determines which parameters the function returns. The function supports only 2-port ABCD parameters; thus, the output is always a vector.

**Example:** `a_vector = rfparam(habcd,'A');`

<b>Purpose</b>	Plot S-parameter data
<b>Syntax</b>	<pre>rfplot(hs,i,j) rfplot(hs) rfplot( ____,LineSpec) hfig = rfplot( ____)</pre>
<b>Description</b>	<p><code>rfplot(hs,i,j)</code> plots the magnitude of <math>S_{i,j}</math>, in decibels, versus frequency on the current axis.</p> <p><code>rfplot(hs)</code> plots all S-parameter vectors in <code>hs</code> (<math>S_{11}</math>, <math>S_{12}</math> ... <math>S_{NN}</math>) on the current axis.</p> <p><code>rfplot( ____,LineSpec)</code> plots S-parameters using optional line types, symbols, and colors specified by <code>LineSpec</code>.</p> <p><code>hfig = rfplot( ____)</code> plots the S-parameters and returns the handle to the figure, <code>hfig</code>.</p>
<b>Input Arguments</b>	<p><b>hs - S-parameters</b> network parameter object</p> <p>S-parameters, specified as an RF Toolbox network parameter object. To create this type of object, use the <code>sparameters</code> function.</p> <p><b>i - Row index</b> positive integer</p> <p>Row index of data to plot, specified as a positive integer.</p> <p><b>j - Column index</b> positive integer</p> <p>Column index of data to plot, specified as a positive integer.</p> <p><b>LineSpec - Line specification</b></p>

string specifier

Argument that modifies the line types, symbols, and colors of the plot, specified as a character string. The function takes string specifiers in the same format as those accepted by the `plot` command. For more information on line specification strings, see `linespec`.

**Example:** `'-or'`

## Output Arguments

### **hfig - Figure**

figure handle

Figure containing the S-parameter plot, returned as a figure handle.

## Examples

### **Plot S-parameter data**

Create an S-parameter object from data in the file `default.s2p`.

```
hs = sparameters('default.s2p');
```

Plot all S-parameters. The data describes a 2-port network, and thus  $S_{11}$ ,  $S_{12}$ ,  $S_{21}$ , and  $S_{22}$  appear on the plot.

```
figure;  
rfplot(hs)
```

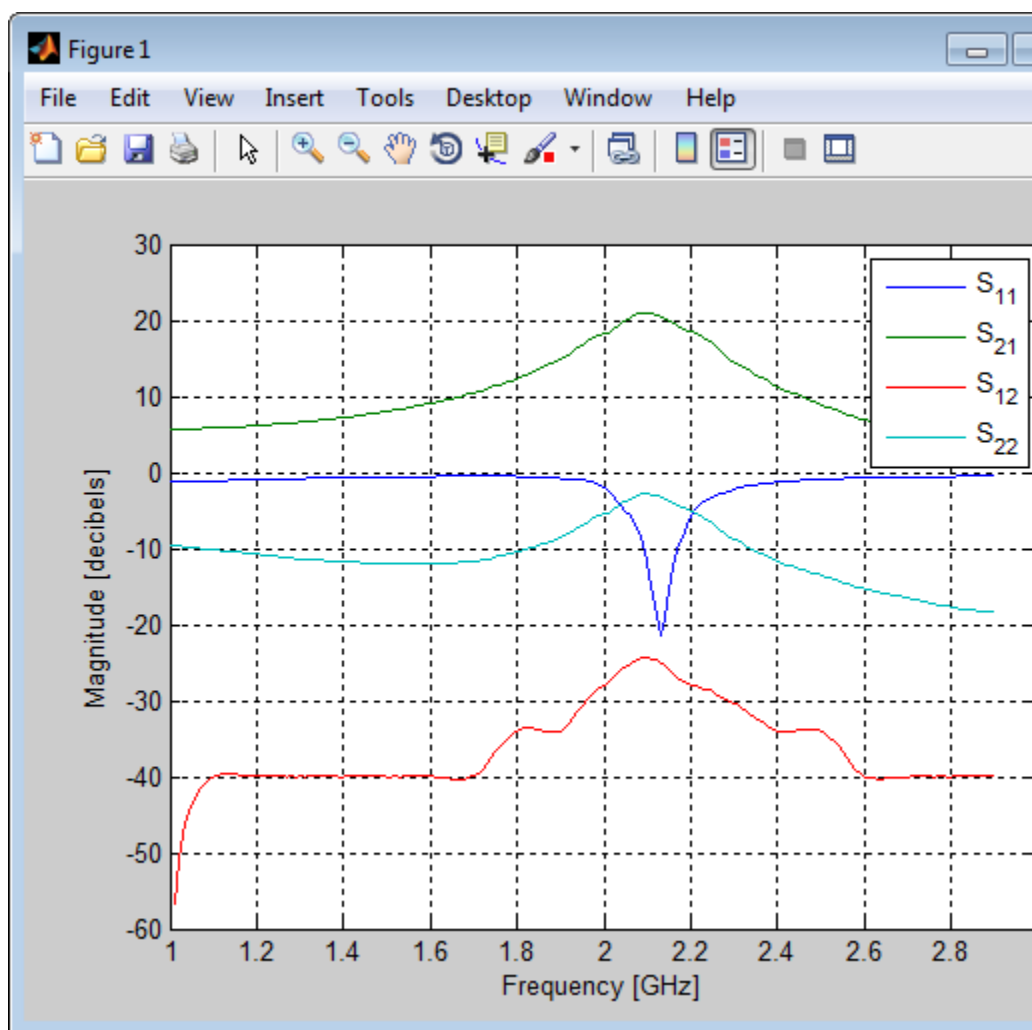

To plot  $S_{21}$  only, provide additional inputs to `rfplot`.

```
figure;  
rfplot(hs,2,1)
```

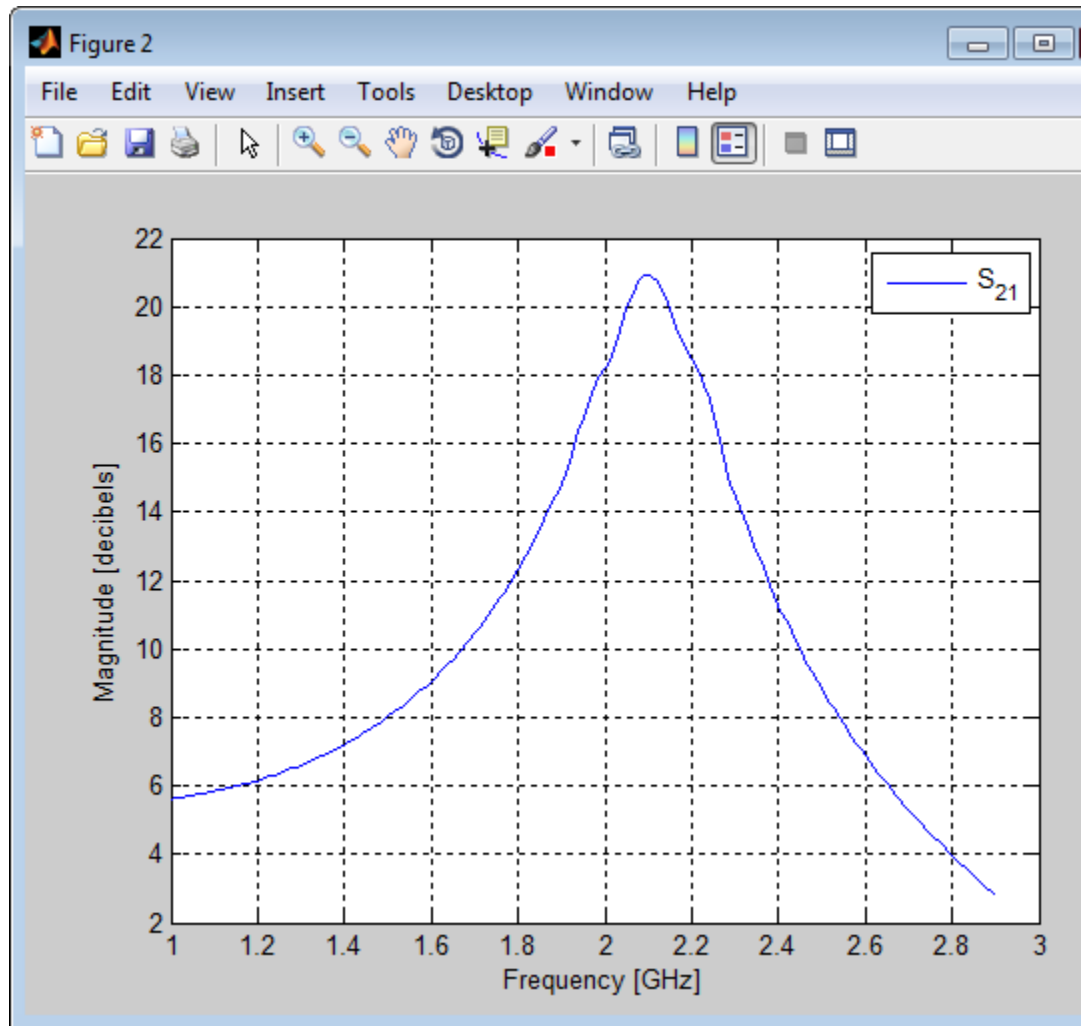

**See Also**

smith

**Purpose** Create S-parameter object

**Syntax**

```
hs = sparameters(filename)

hs = sparameters(hnet)
hs = sparameters(data,freq)
hs = sparameters(___,Z0)
```

**Description** `hs = sparameters(filename)` creates an S-parameter object `hs` by importing data from the Touchstone file specified by `filename`.

`hs = sparameters(hnet)` creates an S-parameter object from the RF Toolbox network parameter object `hnet`.

`hs = sparameters(data,freq)` creates an S-parameter object from the S-parameter data, `data`, and frequencies, `freq`.

`hs = sparameters(___,Z0)` creates an S-parameter object with a reference impedance of `Z0`.

## Input Arguments

### **data - S-parameter data**

array of complex data

S-parameter data, specified as an  $N$ -by- $N$ -by- $K$  array of complex numbers. The function uses this input argument to set the value of the `Parameters` property of `hs`.

### **filename - Touchstone data file that contains network parameter data**

string

Touchstone data file, specified as a string. `filename` can be the name of a file on the MATLAB path or the full path to a file.

**Example:** `hs = sparameters('defaultbandpass.s2p');`

## **freq - S-parameter frequencies**

vector of increasing positive scalars

S-parameter frequencies, specified as a vector of positive real numbers sorted from smallest to largest. The function uses this input argument to set the value of the `Frequencies` property of `hs`.

## **hnet - Network parameter data**

network parameter object

Network parameter data, specified as a network parameter object. If `hnet` is an S-parameter object, then `hs` is a deep copy of `hnet`. Otherwise, the function performs a network parameter conversion to create `hs`. When converting network parameters, the same restrictions apply as those for RF Toolbox network parameter data conversion functions:

- ABCD parameter objects support  $2N$ -port data.
- Hybrid-g parameter objects support 2-port data.
- H-parameter objects support 2-port data.
- S-parameter objects support  $N$ -port data.
- Y-parameter objects support  $N$ -port data.
- Z-parameter objects support  $N$ -port data.

## **Z0 - Reference impedance**

positive real scalar | 50 (default)

Characteristic impedance in ohms, specified as a positive real scalar. The function uses this input argument to set the value of the `Impedance` property of `hs`. You cannot specify `Z0` if you are importing data from a file.

When making a deep copy of an S-parameter object, this input argument is not supported. To change the reference impedance of an S-parameters object, use `newref`.



## Output Arguments

### hs - S-parameter object

network parameter object

S-parameter data, returned as a network parameter object. `disp(hs)` returns the properties of the object:

- **NumPorts** — Number of ports, specified as an integer. The function calculates this value automatically when you create the object.
- **Frequencies** — S-parameter frequencies, specified as a  $K$ -by-1 vector of positive real numbers sorted from smallest to largest. The function sets this property from the `filename` or `freq` input arguments.
- **Parameters** — S-parameter data, specified as an  $N$ -by- $N$ -by- $K$  array of complex numbers. The function sets this property from the `filename` or `data` input arguments.
- **Impedance** — Reference impedance in ohms, specified as a positive real scalar. The function sets this property from the `filename` or `Z0` input arguments. If no reference impedance is provided, the function uses a default value of 50.

## See Also

`abcdparameters` | `gparameters` | `hparameters` | `yparameters` | `zparameters` | `rfparam` | `rfplot`

# abcdparameters

---

**Purpose** Create ABCD parameter object

**Syntax** `habcd = abcdparameters(filename)`

`habcd = abcdparameters(hnet)`  
`habcd = abcdparameters(data,freq)`

**Description** `habcd = abcdparameters(filename)` creates an ABCD parameter object `habcd` by importing data from the Touchstone file specified by `filename`.

`habcd = abcdparameters(hnet)` creates an ABCD parameter object from the RF Toolbox network parameter object `hnet`.

`habcd = abcdparameters(data,freq)` creates an ABCD parameter object from the ABCD parameter data, `data`, and frequencies, `freq`.

## Input Arguments

### **data - ABCD parameter data**

array of complex data

ABCD parameter data, specified as a  $2N$ -by- $2N$ -by- $K$  array of complex numbers. The function uses this input argument to set the value of the `Parameters` property of `habcd`.

### **filename - Touchstone data file that contains network parameter data**

string

Touchstone data file, specified as a string. `filename` can be the name of a file on the MATLAB path or the full path to a file.

**Example:** `habcd = abcdparameters('defaultbandpass.s2p');`

### **freq - ABCD parameter frequencies**

vector of increasing positive scalars

ABCD parameter frequencies, specified as a vector of positive real numbers sorted from smallest to largest. The function uses this input argument to set the value of the `Frequencies` property of `habcd`.

## **hnet - Network parameter data**

network parameter object

Network parameter data, specified as a network parameter object. If `hnet` is an ABCD parameter object, then `habcd` is a deep copy of `hnet`. Otherwise, the function performs a network parameter conversion to create `habcd`. When converting network parameters, the same restrictions apply as those for RF Toolbox network parameter data conversion functions:

- ABCD parameter objects support  $2N$ -port data.
- Hybrid-g parameter objects support 2-port data.
- Hybrid parameter objects support 2-port data.
- S-parameter objects support  $N$ -port data.
- Y-parameter objects support  $N$ -port data.
- Z-parameter objects support  $N$ -port data.

## **Output Arguments**

### **habcd - ABCD parameter object**

network parameter object

ABCD parameter data, returned as a network parameter object. `disp(habcd)` returns the properties of the object:

- `NumPorts` — Number of ports, specified as an integer. The function calculates this value automatically when you create the object.
- `Frequencies` — ABCD parameter frequencies, specified as a  $K$ -by-1 vector of positive real numbers sorted from smallest to largest. The function sets this property from the `filename` or `freq` input arguments.

# abcdparameters

---

- **Parameters** — ABCD parameter data, specified as a  $2N$ -by- $2N$ -by- $K$  array of complex numbers. The function sets this property from the `filename` or `data` input arguments.

## See Also

[gparameters](#) | [hparameters](#) | [sparameters](#) | [yparameters](#) | [zparameters](#) | [rfparam](#)

**Purpose** Create hybrid-g parameter object

**Syntax**

```
hg = gparameters(filename)

hg = gparameters(hnet)
hg = gparameters(data, freq)
```

**Description** `hg = gparameters(filename)` creates a hybrid-g parameter object `hg` by importing data from the Touchstone file specified by `filename`.

`hg = gparameters(hnet)` creates a hybrid-g parameter object from the RF Toolbox network parameter object `hnet`.

`hg = gparameters(data, freq)` creates a hybrid-g parameter object from the g-parameter data, `data`, and frequencies, `freq`.

## Input Arguments

### **data - Hybrid-g parameter data**

array of complex data

Hybrid-g parameter data, specified as a 2-by-2-by- $K$  array of complex numbers. The function uses this input argument to set the value of the `Parameters` property of `hg`.

### **filename - Touchstone data file that contains network parameter data**

string

Touchstone data file, specified as a string. `filename` can be the name of a file on the MATLAB path or the full path to a file.

**Example:** `hg = gparameters('defaultbandpass.s2p');`

### **freq - Hybrid-g parameter frequencies**

vector of increasing positive scalars

Hybrid-g parameter frequencies, specified as a vector of positive real numbers sorted from smallest to largest. The function uses this input argument to set the value of the `Frequencies` property of `hg`.

## **hnet - Network parameter data**

network parameter object

Network parameter data, specified as a network parameter object. If `hnet` is a hybrid-g parameter object, then `hg` is a deep copy of `hnet`. Otherwise, the function performs a network parameter conversion to create `hg`. When converting network parameters, the same restrictions apply as those for RF Toolbox network parameter data conversion functions:

- ABCD parameter objects support  $2N$ -port data.
- Hybrid-g parameter objects support 2-port data.
- Hybrid parameter objects support 2-port data.
- S-parameter objects support  $N$ -port data.
- Y-parameter objects support  $N$ -port data.
- Z-parameter objects support  $N$ -port data.

## **Output Arguments**

### **hg - Hybrid-g parameter object**

network parameter object

Hybrid-g parameter data, returned as a network parameter object. `disp(hg)` returns the properties of the object:

- `Frequencies` — Hybrid-g parameter frequencies, specified as a  $K$ -by-1 vector of positive real numbers sorted from smallest to largest. The function sets this property from the `filename` or `freq` input arguments.
- `Parameters` — Hybrid-g parameter data, specified as an  $N$ -by- $N$ -by- $K$  array of complex numbers. The function sets this property from the `filename` or `data` input arguments.

## See Also

[abcdparameters](#) | [hparameters](#) | [sparameters](#) | [yparameters](#) | [zparameters](#) | [rfparam](#)

# hparameters

---

**Purpose** Create hybrid parameter object

**Syntax**

```
hh = hparameters(filename)

hh = hparameters(hnet)
hh = hparameters(data, freq)
```

**Description** `hh = hparameters(filename)` creates a hybrid parameter object `hh` by importing data from the Touchstone file specified by `filename`.

`hh = hparameters(hnet)` creates a hybrid parameter object from the RF Toolbox network parameter object `hnet`.

`hh = hparameters(data, freq)` creates a hybrid parameter object from the hybrid parameter data, `data`, and frequencies, `freq`.

## Input Arguments

### **data - Hybrid parameter data**

array of complex data

Hybrid parameter data, specified as 2-by-2-by- $K$  array of complex numbers. The function uses this input argument to set the value of the `Parameters` property of `hh`.

### **filename - Touchstone data file that contains network parameter data**

string

Touchstone data file, specified as a string. `filename` can be the name of a file on the MATLAB path or the full path to a file.

**Example:** `hh = hparameters('defaultbandpass.s2p');`

### **freq - Hybrid parameter frequencies**

vector of increasing positive scalars



Hybrid parameter frequencies, specified as a vector of positive real numbers sorted from smallest to largest. The function uses this input argument to set the value of the `Frequencies` property of `hh`.

## **hnet - Network parameter data**

network parameter object

Network parameter data, specified as a network parameter object. If `hnet` is a hybrid parameter object, then `hh` is a deep copy of `hnet`. Otherwise, the function performs a network parameter conversion to create `hh`. When converting network parameters, the same restrictions apply as those for RF Toolbox network parameter data conversion functions:

- ABCD parameter objects support  $2N$ -port data.
- Hybrid-g parameter objects support 2-port data.
- Hybrid parameter objects support 2-port data.
- S-parameter objects support  $N$ -port data.
- Y-parameter objects support  $N$ -port data.
- Z-parameter objects support  $N$ -port data.

## **Output Arguments**

### **hh - Hybrid parameter object**

network parameter object

Hybrid parameter data, returned as a network parameter object. `disp(hh)` returns the properties of the object:

- `Frequencies` — Hybrid parameter frequencies, specified as a  $K$ -by-1 vector of positive real numbers sorted from smallest to largest. The function sets this property from the `filename` or `freq` input arguments.
- `Parameters` — Hybrid parameter data, specified as a 2-by-2-by- $K$  array of complex numbers. The function sets this property from the `filename` or `data` input arguments.

# hparameters

---

## **See Also**

[abcdparameters](#) | [gparameters](#) | [sparameters](#) | [yparameters](#) | [zparameters](#) | [rfparam](#)

## Purpose

Create Y-parameter object

## Syntax

```
hy = yparameters(filename)
```

```
hy = yparameters(hnet)
```

```
hy = yparameters(data, freq)
```

## Description

`hy = yparameters(filename)` creates a Y-parameter object `hy` by importing data from the Touchstone file specified by `filename`.

`hy = yparameters(hnet)` creates a Y-parameter object from the RF Toolbox network parameter object `hnet`.

`hy = yparameters(data, freq)` creates a Y-parameter object from the Y-parameter data, `data`, and frequencies, `freq`.

## Input Arguments

### **data - Y-parameter data**

array of complex data

Y-parameter data, specified as an  $N$ -by- $N$ -by- $K$  array of complex numbers. The function uses this input argument to set the value of the `Parameters` property of `hy`.

### **filename - Touchstone data file that contains network parameter data**

string

Touchstone data file, specified as a string. `filename` can be the name of a file on the MATLAB path or the full path to a file.

**Example:** `hy = yparameters('defaultbandpass.s2p');`

### **freq - Y-parameter frequencies**

vector of increasing positive scalars

Y-parameter frequencies, specified as a vector of positive real numbers sorted from smallest to largest. The function uses this input argument to set the value of the `Frequencies` property of `hy`.

## **hnet - Network parameter data**

network parameter object

Network parameter data, specified as a network parameter object. If `hnet` is a Y-parameter object, then `hy` is a deep copy of `hnet`. Otherwise, the function performs a network parameter conversion to create `hy`. When converting network parameters, the same restrictions apply as those for RF Toolbox network parameter data conversion functions:

- ABCD parameter objects support  $2N$ -port data.
- Hybrid-g parameter objects support 2-port data.
- Hybrid parameter objects support 2-port data.
- S-parameter objects support  $N$ -port data.
- Y-parameter objects support  $N$ -port data.
- Z-parameter objects support  $N$ -port data.

## **Output Arguments**

### **hy - Y-parameter object**

network parameter object

Y-parameter data, returned as a network parameter object. `disp(hy)` returns the properties of the object:

- `NumPorts` — Number of ports, specified as an integer. The function calculates this value automatically when you create the object.
- `Frequencies` — Y-parameter frequencies, specified as a  $K$ -by-1 vector of positive real numbers sorted from smallest to largest. The function sets this property from the `filename` or `freq` input arguments.
- `Parameters` — Y-parameter data, specified as an  $N$ -by- $N$ -by- $K$  array of complex numbers. The function sets this property from the `filename` or `data` input arguments.

## See Also

[abcdparameters](#) | [gparameters](#) | [hparameters](#) | [sparameters](#) | [zparameters](#) | [rfparam](#)

# zparameters

---

**Purpose** Create Z-parameter object

**Syntax** `hz = zparameters(filename)`

`hz = zparameters(hnet)`  
`hz = zparameters(data, freq)`  
`hz = zparameters( ___, Z0)`

**Description** `hz = zparameters(filename)` creates a Z-parameter object `hz` by importing data from the Touchstone file specified by `filename`.

`hz = zparameters(hnet)` creates a Z-parameter object from the RF Toolbox network parameter object `hnet`.

`hz = zparameters(data, freq)` creates a Z-parameter object from the Z-parameter data, `data`, and frequencies, `freq`.

`hz = zparameters( ___, Z0)` creates a Z-parameter object using the previously described syntax, with a reference impedance of `Z0`.

## Input Arguments

### **data - Z-parameter data**

array of complex data

Z-parameter data, specified as an  $N$ -by- $N$ -by- $K$  array of complex numbers. The function uses this input argument to set the value of the `Parameters` property of `hz`.

### **filename - Touchstone data file that contains network parameter data**

string

Touchstone data file, specified as a string. `filename` can be the name of a file on the MATLAB path or the full path to a file.

**Example:** `hz = zparameters('defaultbandpass.s2p');`

**freq - Z-parameter frequencies**

vector of increasing positive scalars

Z-parameter frequencies, specified as a vector of positive real numbers sorted from smallest to largest. The function uses this input argument to set the value of the `Frequencies` property of `hz`.

**hnet - Network parameter data**

network parameter object

Network parameter data, specified as a network parameter object. If `hnet` is a Z-parameter object, then `hz` is a deep copy of `hnet`. Otherwise, the function performs a network parameter conversion to create `hz`. When converting network parameters, the same restrictions apply as those for RF Toolbox network parameter data conversion functions:

- ABCD parameter objects support  $2N$ -port data.
- Hybrid-g parameter objects support 2-port data.
- Hybrid parameter objects support 2-port data.
- S-parameter objects support  $N$ -port data.
- Y-parameter objects support  $N$ -port data.
- Z-parameter objects support  $N$ -port data.

**Output Arguments****hz - Z-parameter object**

network parameter object

Z-parameter data, returned as a network parameter object. `disp(hz)` returns the properties of the object:

- `NumPorts` — Number of ports, specified as an integer. The function calculates this value automatically when you create the object.
- `Frequencies` — Z-parameter frequencies, specified as a  $K$ -by-1 vector of positive real numbers sorted from smallest to largest. The function sets this property from the `filename` or `freq` input arguments.

## zparameters

---

- `Parameters` — Z-parameter data, specified as an  $N$ -by- $N$ -by- $K$  array of complex numbers. The function sets this property from the `filename` or `data` input arguments.

### See Also

`abcdparameters` | `gparameters` | `hparameters` | `sparameters` | `yparameters` | `rfparam`



# Function Reference

---

Calculations (p. 10-2)

Calculate parameters of circuit objects, model objects, and networks

Data Visualization (p. 10-3)

Display circuit object parameters

Utilities (p. 10-4)

Calculate intermediate results

Network Parameter Conversion  
(p. 10-5)

Convert network parameters  
between formats

GUI (p. 10-8)

Open the RF Analysis Tool

## Calculations

<code>cascadesparams</code>	Combine S-parameters to form cascaded network
<code>deembedsparams</code>	De-embed 2-port S-parameters
<code>gamma2z</code>	Convert reflection coefficient to impedance
<code>gammain</code>	Input reflection coefficient of 2-port network
<code>gammaml</code>	Load reflection coefficient of 2-port network
<code>gammams</code>	Source reflection coefficient of 2-port network
<code>gammaout</code>	Output reflection coefficient of 2-port network
<code>ispassive</code>	Check passivity of N-port S-parameters
<code>makepassive</code>	Enforce passivity of S-parameters
<code>powergain</code>	Power gain of 2-port network
<code>rationalfit</code>	Approximate data using stable rational function
<code>s2tf</code>	Convert S-parameters of 2-port network to voltage or power-wave transfer function
<code>stabilityk</code>	Stability factor $K$ of 2-port network
<code>stabilitymu</code>	Stability factor $\mu$ of 2-port network
<code>vswr</code>	VSWR at given reflection coefficient $\Gamma$
<code>z2gamma</code>	Convert impedance to reflection coefficient

## Data Visualization

smithchart

Plot complex vector on Smith chart

## Utilities

copy

Copy circuit or data object

getdata

Data object containing analyzed  
result of specified circuit object

## Network Parameter Conversion

abcd2h	Convert ABCD-parameters to hybrid h-parameters
abcd2s	Convert ABCD-parameters to S-parameters
abcd2y	Convert ABCD-parameters to Y-parameters
abcd2z	Convert ABCD-parameters to Z-parameters
g2h	Convert hybrid g-parameters to hybrid h-parameters
h2abcd	Convert hybrid h-parameters to ABCD-parameters
h2g	Convert hybrid h-parameters to hybrid g-parameters
h2s	Convert hybrid h-parameters to S-parameters
h2y	Convert hybrid h-parameters to Y-parameters
h2z	Convert hybrid h-parameters to Z-parameters
r1gc2s	Convert RLGC transmission line parameters to S-parameters
s2abcd	Convert S-parameters to ABCD-parameters
s2h	Convert S-parameters to hybrid h-parameters
s2r1gc	Convert S-parameters to RLGC transmission line parameters
s2s	Convert S-parameters to S-parameters with different impedance

s2scc	Convert single-ended S-parameters to common-mode S-parameters (S)
s2scd	Convert 4-port, single-ended S-parameters to 2-port, cross-mode S-parameters (S)
s2sdc	Convert 4-port, single-ended S-parameters to 2-port, cross-mode S-parameters (S)
s2sdd	Convert 4-port, single-ended S-parameters to 2-port, differential-mode S-parameters (S)
s2smm	Convert single-ended S-parameters to mixed-mode S-parameters
s2t	Convert S-parameters to T-parameters
s2y	Convert S-parameters to Y-parameters
s2z	Convert S-parameters to Z-parameters
smm2s	Convert mixed-mode 2N-port S-parameters to single-ended 4N-port S-parameters
snp2smp	Convert single-ended N-port S-parameters to single-ended M-port S-parameters
t2s	Convert T-parameters to S-parameters
y2abcd	Convert Y-parameters to ABCD-parameters
y2h	Convert Y-parameters to hybrid h-parameters

y2s	Convert Y-parameters to S-parameters
y2z	Convert Y-parameters to Z-parameters
z2abcd	Convert Z-parameters to ABCD-parameters
z2h	Convert Z-parameters to hybrid h-parameters
z2s	Convert Z-parameters to S-parameters
z2y	Convert Z-parameters to Y-parameters

## **GUI**

`rftool`

Open RF Analysis Tool (RF Tool)



# Functions — Alphabetical List

---

# abcd2h

---

**Purpose** Convert ABCD-parameters to hybrid h-parameters

**Syntax** `h_params = abcd2h(abcd_params)`

**Description** `h_params = abcd2h(abcd_params)` converts the ABCD-parameters `abcd_params` into the hybrid parameters `h_params`. The `abcd_params` input is a complex 2-by-2-by- $M$  array, representing  $M$  2-port ABCD-parameters. `h_params` is a complex 2-by-2-by- $M$  array, representing  $M$  2-port hybrid h-parameters.

**Alternatives** You can also use network parameter objects to perform network parameter conversions. For more information, see “RF Network Parameter Objects” on page 2-12.

**Examples** Convert ABCD-parameters to h-parameters:

```
%Define a matrix of ABCD-parameters.  
A = 0.999884396265344 + 0.000129274757618717i;  
B = 0.314079483671772 + 2.51935878310427i;  
C = -6.56176712108866e-007 + 6.67455405306704e-006i;  
D = 0.999806365547959 + 0.000247230611054075i;  
abcd_params = [A,B; C,D];  
%Convert to h-parameters  
h_params = abcd2h(abcd_params);
```

**See Also** `abcd2s` | `abcd2y` | `abcd2z` | `h2abcd` | `s2h` | `y2h` | `z2h`

**Purpose** Convert ABCD-parameters to S-parameters

**Syntax** `s_params = abcd2s(abcd_params, z0)`

**Description** `s_params = abcd2s(abcd_params, z0)` converts the ABCD-parameters `abcd_params` into the scattering parameters `s_params`. The `abcd_params` input is a complex  $2N$ -by- $2N$ -by- $M$  array, representing  $M$   $2N$ -port ABCD-parameters. `z0` is the reference impedance; its default is 50 ohms. The function assumes that the ABCD-parameter matrices have distinct  $A$ ,  $B$ ,  $C$ , and  $D$  submatrices:

$$\begin{bmatrix} [A] & [B] \\ [C] & [D] \end{bmatrix}$$

`s_params` is a complex  $2N$ -by- $2N$ -by- $M$  array, representing  $M$   $2N$ -port S-parameters.

**Alternatives** You can also use network parameter objects to perform network parameter conversions. For more information, see “RF Network Parameter Objects” on page 2-12.

**Examples** Convert ABCD-parameters to S-parameters:

```
%Define a matrix of ABCD-parameters.
A =      0.999884396265344 + 0.000129274757618717i;
B =      0.314079483671772 +      2.51935878310427i;
C = -6.56176712108866e-007 + 6.67455405306704e-006i;
D =      0.999806365547959 + 0.000247230611054075i;
abcd_params = [A,B; C,D];
%Convert to S-parameters
s_params = abcd2s(abcd_params);
```

**See Also** `abcd2h` | `abcd2y` | `abcd2z` | `s2abcd` | `s2h` | `y2h` | `z2h`

# abcd2y

---

**Purpose** Convert ABCD-parameters to Y-parameters

**Syntax** `y_params = abcd2y(abcd_params)`

**Description** `y_params = abcd2y(abcd_params)` converts the ABCD-parameters `abcd_params` into the admittance parameters `y_params`. The `abcd_params` input is a complex  $2N$ -by- $2N$ -by- $M$  array, representing  $M$   $2N$ -port ABCD-parameters. The function assumes that the ABCD-parameter matrices have distinct  $A$ ,  $B$ ,  $C$ , and  $D$  submatrices:

$$\begin{bmatrix} [A] & [B] \\ [C] & [D] \end{bmatrix}$$

`y_params` is a complex  $2N$ -by- $2N$ -by- $M$  array, representing  $M$   $2N$ -port Y-parameters.

**Alternatives** You can also use network parameter objects to perform network parameter conversions. For more information, see “RF Network Parameter Objects” on page 2-12.

**Examples** Convert ABCD-parameters to Y-parameters:

```
%Define a matrix of ABCD-parameters.  
A = 0.999884396265344 + 0.000129274757618717i;  
B = 0.314079483671772 + 2.51935878310427i;  
C = -6.56176712108866e-007 + 6.67455405306704e-006i;  
D = 0.999806365547959 + 0.000247230611054075i;  
abcd_params = [A,B; C,D];  
%Convert to Y-parameters  
y_params = abcd2y(abcd_params);
```

**See Also** `abcd2h` | `abcd2s` | `abcd2z` | `h2y` | `s2y` | `y2abcd` | `z2y`

**Purpose** Convert ABCD-parameters to Z-parameters

**Syntax** `z_params = abcd2z(abcd_params)`

**Description** `z_params = abcd2z(abcd_params)` converts the ABCD-parameters `abcd_params` into the impedance parameters `z_params`. The `abcd_params` input is a complex  $2N$ -by- $2N$ -by- $M$  array, representing  $M$   $2N$ -port ABCD-parameters. The function assumes that the ABCD-parameter matrices have distinct  $A$ ,  $B$ ,  $C$ , and  $D$  submatrices:

$$\begin{bmatrix} [A] & [B] \\ [C] & [D] \end{bmatrix}$$

`z_params` is a complex  $2N$ -by- $2N$ -by- $M$  array, representing  $M$   $2N$ -port Z-parameters.

**Alternatives** You can also use network parameter objects to perform network parameter conversions. For more information, see “RF Network Parameter Objects” on page 2-12.

**Examples** Convert ABCD-parameters to Z-parameters:

```
%Define a matrix of ABCD-parameters.
A =      0.999884396265344 + 0.000129274757618717i;
B =      0.314079483671772 +      2.51935878310427i;
C = -6.56176712108866e-007 + 6.67455405306704e-006i;
D =      0.999806365547959 + 0.000247230611054075i;
abcd_params = [A,B; C,D];
%Convert to Z-parameters
z_params = abcd2z(abcd_params);
```

**See Also** `abcd2h` | `abcd2s` | `abcd2y` | `h2y` | `y2abcd` | `z2abcd`

# cascadesparams

---

**Purpose** Combine S-parameters to form cascaded network

**Syntax**

```
s_params = cascadesparams(s1_params,s2_params,...,sk_params)
hs = cascadesparams(hs1,hs2,...,hsk)
s_params = cascadesparams(s1_params,s2_params,...,sk_params,
    Kconn)
```

**Description** `s_params = cascadesparams(s1_params,s2_params,...,sk_params)` cascades the scattering parameters of the  $K$  input networks described by the S-parameters `s1_params` through `sk_params`. The function stores the S-parameters of the cascade in `s_params`. Each of the input networks must be a  $2N$ -port network described by a  $2N$ -by- $2N$ -by- $M$  array of S-parameters. All networks must have the same reference impedance.

`hs = cascadesparams(hs1,hs2,...,hsk)` cascades  $K$  S-parameter objects to create the cascaded network `hs`. The function checks that the Impedance and Frequencies properties of each object are equal and that the Parameters property contains a  $2N$ -by- $2N$ -by- $M$  array of S-parameters.

`cascadesparams` assumes that you are using the port ordering given in the following illustration.

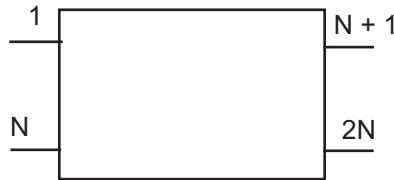

Based on this ordering, the function connects ports  $N + 1$  through  $2N$  of the first network to ports 1 through  $N$  of the second network. Therefore, when you use this syntax:

- Each network has an even number of ports
- Every network in the cascade has the same number of ports.

To use this function for S-parameters with different port arrangements, use the `snp2smp` function to reorder the port indices before cascading the networks.

```
s_params =  
cascadesparams(s1_params, s2_params, ..., sk_params, Kconn)  
cascades the scattering parameters of the  $K$  input networks described  
by the S-parameters s1_params through sk_params. The function  
creates a cascaded network based on the number of cascade  
connections between networks, specified by Kconn. Kconn must be a  
positive scalar or vector of size  $K - 1$ .
```

- If `Kconn` is a scalar, `cascadesparams` makes the same number of connections between each pair of consecutive networks.
- If `Kconn` is a vector, the  $i$ th element of `Kconn` specifies the number of connections between the  $i$ th and the  $i+1$ th networks.

`cascadesparams` always connects the last `Kconn(i)` ports of the  $i$ th network and the first `Kconn(i)` ports of the  $i+1$ th network. The ports of the entire cascaded network represent the unconnected ports of each individual network, taken in order from the first network to the  $n$ th network.

Additionally, when you specify `Kconn`:

- Each network can have either an even or odd number of ports.
- Every network in the cascade can have a different number of ports.

## Examples

Assemble a 2-port cascaded network from two sets of 2-port S-parameters:

```
%Create two sets of 2-port S-parameters  
ckt1 = read(rfckt.amplifier, 'default.s2p');  
ckt2 = read(rfckt.passive, 'passive.s2p');  
freq = [2e9 2.1e9];  
analyze(ckt1, freq);  
analyze(ckt2, freq);  
sparams_2p_1 = ckt1.AnalyzedResult.S_Parameters;  
sparams_2p_2 = ckt2.AnalyzedResult.S_Parameters;
```

# cascadesparams

---

```
%Cascade the S-parameters  
sparams_cascaded_2p = ...  
    cascadesparams(sparams_2p_1, sparams_2p_2)
```

---

Assemble a 3-port cascaded network from a set of 3-port S-parameters and a set of 2-port S-parameters:

```
% Create one set of 3-port S-parameters  
% and one set of 2-port S-parameters  
ckt1 = read(rfckt.passive, 'default.s3p');  
ckt2 = read(rfckt.amplifier, 'default.s2p');  
freq = [2e9 2.1e9];  
analyze(ckt1, freq);  
analyze(ckt2, freq);  
sparams_3p = ckt1.AnalyzedResult.S_Parameters;  
sparams_2p = ckt2.AnalyzedResult.S_Parameters;  
%Cascade the two sets by connecting one port between them  
Kconn = 1  
sparams_cascaded_3p = ...  
    cascadesparams(sparams_3p, sparams_2p, Kconn)
```

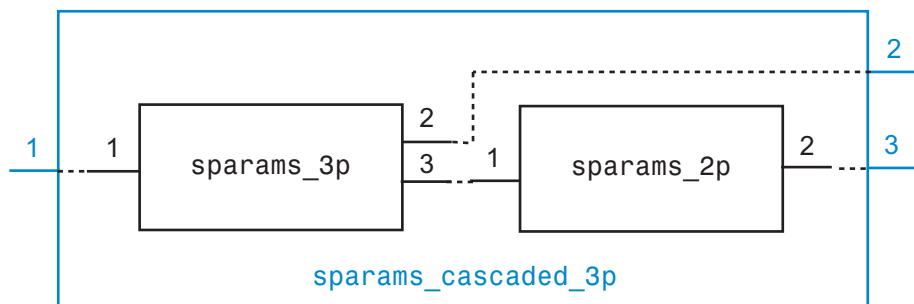

Assemble a 3-port cascaded network from a set of 3-port S-parameters and a set of 2-port S-parameters, connecting the second port of the 3-port network to the first port of the 2-port network:



```

ckt1 = read(rfckt.passive,'default.s3p');
ckt2 = read(rfckt.amplifier,'default.s2p');
freq = [2e9 2.1e9];
analyze(ckt1,freq);
analyze(ckt2,freq);
sparams_3p = ckt1.AnalyzedResult.S_Parameters;
sparams_2p = ckt2.AnalyzedResult.S_Parameters;
%Reorder the second and third ports of the 3-port network
sparams_3p_2 = snp2smp(sparams_3p,50,[1 3 2])
%Cascade the two sets by connecting one port between them
Kconn = 1
sparams_cascaded_3p_2 = cascadesparams(sparams_3p_2,...
    sparams_2p,Kconn)

```

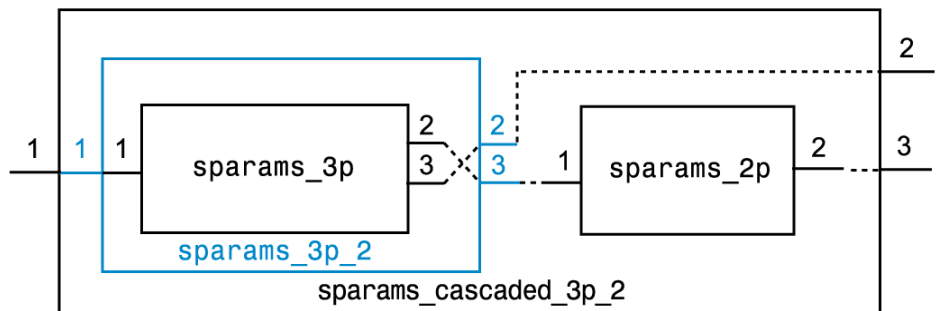

Assemble a 3-port cascaded network from a set of 3-port S-parameters and two sets of 2-port S-parameters:

```

ckt1 = read(rfckt.passive,'default.s3p');
ckt2 = read(rfckt.amplifier,'default.s2p');
ckt3 = read(rfckt.passive,'passive.s2p');
freq = [2e9 2.1e9];
analyze(ckt1,freq);
analyze(ckt2,freq);
analyze(ckt3,freq);
sparams_3p = ckt1.AnalyzedResult.S_Parameters;

```

# cascadesparams

```
sparams_2p_1 = ckt2.AnalyzedResult.S_Parameters;  
sparams_2p_2 = ckt3.AnalyzedResult.S_Parameters;  
%Connect one port between each set of adjacent networks  
Kconn = [1 1]  
sparams_cascaded_3p_3 = cascadesparams(sparams_3p,...  
    sparams_2p_1,sparams_2p_2,Kconn)
```

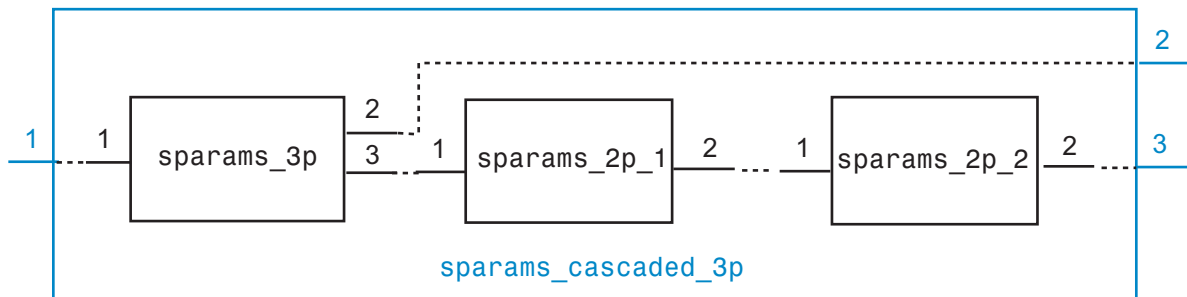

Assemble a 3-port cascaded network from a set of 3-port S-parameters and two sets of 2-port S-parameters, connecting the 3-port network to both 2-port networks:

```
ckt1 = read(rfckt.passive,'default.s3p');  
ckt2 = read(rfckt.amplifier,'default.s2p');  
ckt3 = read(rfckt.passive,'passive.s2p');  
freq = [2e9 2.1e9];  
analyze(ckt1,freq);  
analyze(ckt2,freq);  
analyze(ckt3,freq);  
sparams_3p = ckt1.AnalyzedResult.S_Parameters;  
sparams_2p_1 = ckt2.AnalyzedResult.S_Parameters;  
sparams_2p_2 = ckt3.AnalyzedResult.S_Parameters;  
%Cascade sparams_3p and sparams_2p_1  
%by connecting one port between them  
Kconn = 1  
sparams_cascaded_3p = cascadesparams(...  
    sparams_3p, ...
```

```

sparams_2p_1, ...
Kconn)
%Reorder the second and third ports of the 3-port network
sparams_cascaded_3p_3 = snp2smp(...
    sparams_cascaded_3p, ...
    50, ...
    [1 3 2])
%Cascade sparams_3p and sparams_2p_2
%by connecting one port between them
sparams_cascaded_3p_4 = cascadesparams(...
    sparams_cascaded_3p_3, ...
    sparams_2p_2, ...
    Kconn)

```

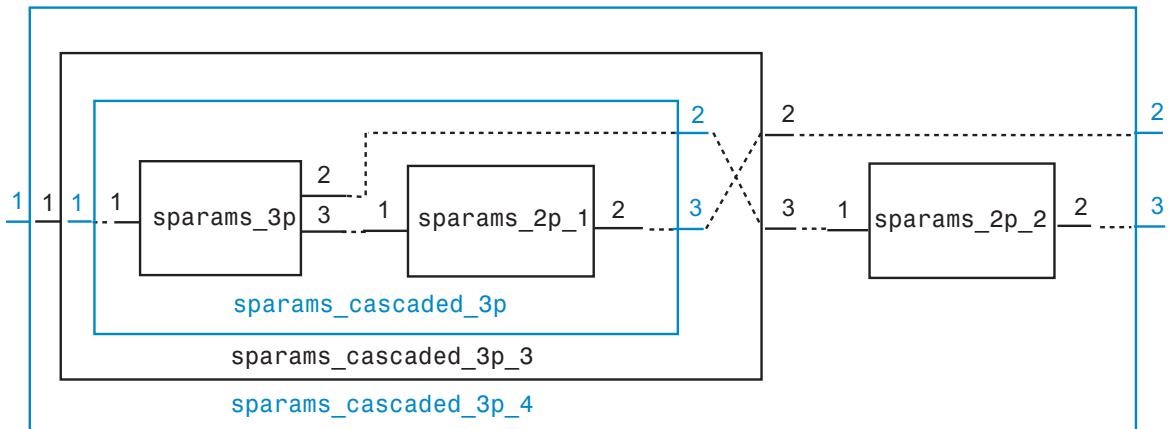

## See Also

[deembedsparams](#) | [rfckt.cascade](#) | [s2t](#) | [t2s](#)

# copy

---

<b>Purpose</b>	Copy circuit or data object
<b>Syntax</b>	<code>h2 = copy(h)</code>
<b>Description</b>	<code>h2 = copy(h)</code> returns a copy of the circuit, data, or network parameter object <code>h</code> .  The syntax <code>h2 = h</code> copies only the object handle and does not create a new object.
<b>Alternatives</b>	The syntax <code>h2 = h</code> copies only the object handle and does not create a new object.
<b>See Also</b>	<code>analyze</code>

**Purpose** De-embed 2-port S-parameters

**Syntax**  
`s2_params = deembedsparams(s_params,s1_params,s3_params)`  
`hs2 = deembedsparams(hs,hs1,hs3)`

**Description** `s2_params = deembedsparams(s_params,s1_params,s3_params)` derives the `s2_params` from the cascaded S-parameters `s_params`, by removing the effects of `s1_params`, and `s3_params`. `s2_params` is a 2-by-2-by- $Q$  array containing the de-embedded S-parameters. This function is ideal for situations in which the S-parameters of a device under test (DUT) must be de-embedded from S-parameters obtained through measurement.

The function assumes the configuration of the cascade shown in the following illustration.

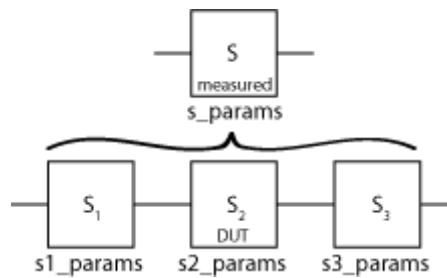

Each of the input networks is a 2-port network described by a 2-by-2-by- $Q$  array of S-parameters. The function assumes that all networks in the cascade have the same reference impedance and are measured at the same frequencies..

`hs2 = deembedsparams(hs,hs1,hs3)` de-embeds `hs2` from the chain `hs`. In this syntax, inputs and outputs are RF Toolbox S-parameter objects. The function checks that the `Frequencies` and `Impedance` properties are the same for all three inputs.

**See Also** `cascadesparams` | `rfckt.cascade`

**Purpose** Convert hybrid g-parameters to hybrid h-parameters

**Syntax** `h_params = g2h(g_params)`

**Description** `h_params = g2h(g_params)` converts the hybrid g-parameters, `g_params`, into the hybrid h-parameters, `h_params`. The `g_params` input is a complex 2-by-2-by- $M$  array, representing  $M$  2-port g-parameters. `h_params` is a complex 2-by-2-by- $M$  array, representing  $M$  2-port h-parameters.

**Alternatives** You can also use network parameter objects to perform network parameter conversions. For more information, see “RF Network Parameter Objects” on page 2-12.

**Examples** Convert g-parameters to h-parameters:

```
%Define a matrix of g-parameters.  
g_11 = -6.55389515512306e-007 + 6.67541048071651e-006i;  
g_12 = -0.999823389146385 - 0.000246785162909241i;  
g_21 = 1.00011560038266 - 0.000129304649930592i;  
g_22 = 0.314441556185771 + 2.51960941000598i;  
g_params = [g_11,g_12; g_21,g_22];  
%Convert to h-parameters  
h_params = g2h(g_params);
```

**See Also** `h2g`

---

<b>Purpose</b>	Convert reflection coefficient to impedance
<b>Syntax</b>	<pre>z = gamma2z (gamma) z = gamma2z (gamma, z0)</pre>
<b>Description</b>	<p><code>z = gamma2z (gamma)</code> converts the reflection coefficient <code>gamma</code> to the impedance <code>z</code> using a reference impedance <math>Z_0</math> of 50 ohms.</p> <p><code>z = gamma2z (gamma, z0)</code> converts the reflection coefficient <code>gamma</code> to the impedance <code>z</code> by:</p> <ul style="list-style-type: none"><li>• Computing the normalized impedance.</li><li>• Multiplying the normalized impedance by the reference impedance <math>Z_0</math>.</li></ul>
<b>Algorithms</b>	<p>The following equation shows this conversion:</p> $Z = Z_0 * \left( \frac{1 + \Gamma}{1 - \Gamma} \right)$
<b>Examples</b>	<p>Calculate impedance from given reference impedance and reflection coefficient values:</p> <pre>z0 = 50; gamma = 1/3; z = gamma2z (gamma, z0)</pre>
<b>See Also</b>	<code>gammain</code>   <code>gammaout</code>   <code>z2gamma</code>

**Purpose** Input reflection coefficient of 2-port network

**Syntax**  
`coefficient = gammmain(s_params,z0,z1)`  
`coefficient = gammmain(hs,z1)`

**Description**  
`coefficient = gammmain(s_params,z0,z1)` calculates the input reflection coefficient of a 2-port network. `s_params` is a complex 2-by-2-by- $M$  array, representing  $M$  2-port S-parameters. `z0` is the reference impedance  $Z_0$ ; its default value is 50 ohms. `z1` is the load impedance  $Z_l$ ; its default value is also 50 ohms. `coefficient` is an  $M$ -element complex vector.  
`coefficient = gammmain(hs,z1)` calculates the input reflection coefficient of the 2-port network represented by the S-parameter object `hs`.

**Algorithms** `gammmain` uses the formula

$$\Gamma_{in} = S_{11} + \frac{(S_{12}S_{21})\Gamma_L}{1 - S_{22}\Gamma_L}$$

where

$$\Gamma_L = \frac{Z_l - Z_0}{Z_l + Z_0}$$

**Examples** Calculate the input reflection coefficients at each index of an S-parameter array:

```
ckt = read(rfckt.amplifier,'default.s2p');  
s_params = ckt.NetworkData.Data;  
z0 = ckt.NetworkData.Z0;  
z1 = 100;  
coefficient = gammmain(s_params,z0,z1);
```

**See Also** `gamma2z` | `gammam1` | `gammams` | `gammaout` | `vswr`



**Purpose** Load reflection coefficient of 2-port network

**Syntax**  
`coefficient = gammaml(s_params)`  
`coefficient = gammaml(hs)`

**Description**  
`coefficient = gammaml(s_params)` calculates the load reflection coefficient of a 2-port network required for simultaneous conjugate match.  
`s_params` is a complex 2-by-2-by- $M$  array, representing  $M$  2-port S-parameters,  $S_{ij}$ . `coefficient` is an  $M$ -element complex vector.  
`coefficient = gammaml(hs)` calculates the load reflection coefficient of the 2-port network represented by the S-parameter object `hs`.

**Algorithms** The function calculates `coefficient` using the equation

$$\Gamma_{ML} = \frac{B_2 \pm \sqrt{B_2^2 - 4|C_2|^2}}{2C_2}$$

where

$$B_2 = 1 - |S_{11}|^2 + |S_{22}|^2 - |\Delta|^2$$

$$C_2 = S_{22} - \Delta \cdot S_{11}^*$$

$$\Delta = S_{11}S_{22} - S_{12}S_{21}$$

**Examples** Calculate the load reflection coefficient using network data from a file:

```

ckt = read(rfckt.amplifier,'default.s2p');
s_params = ckt.NetworkData.Data;
coefficient = gammaml(s_params);

```

**See Also** `gammain` | `gammams` | `gammaout` | `stabilityk`

# gammams

---

**Purpose** Source reflection coefficient of 2-port network

**Syntax**  
`coefficient = gammams(s_params)`  
`coefficient = gammams(hs)`

**Description**  
`coefficient = gammams(s_params)` calculates the source reflection coefficient of a 2-port network required for simultaneous conjugate match. `s_params` is a complex 2-by-2-by- $M$  array, representing  $M$  2-port S-parameters. `coefficient` is an  $M$ -element complex vector.  
`coefficient = gammams(hs)` calculates the source reflection coefficient of the 2-port network represented by the S-parameter object `hs`.

**Algorithms** The function calculates `coefficient` using the equation

$$\Gamma_{MS} = \frac{B_1 \pm \sqrt{B_1^2 - 4|C_1|^2}}{2C_1}$$

where

$$B_1 = 1 + |S_{11}|^2 - |S_{22}|^2 - |\Delta|^2$$

$$C_1 = S_{11} - \Delta \cdot S_{22}^*$$

$$\Delta = S_{11}S_{22} - S_{12}S_{21}$$

**Examples** Calculate the source reflection coefficient using network data from a file:

```
ckt = read(rfckt.amplifier, 'default.s2p');  
s_params = ckt.NetworkData.Data;  
coefficient = gammams(s_params);
```

**See Also** `gammain` | `gammaml` | `gammaout` | `stabilityk`

**Purpose** Output reflection coefficient of 2-port network

**Syntax**  
`coefficient = gammaout(s_params,z0,zs)`  
`coefficient = gammaout(hs,zs)`

**Description** `coefficient = gammaout(s_params,z0,zs)` calculates the output reflection coefficient of a 2-port network.

`s_params` is a complex 2-by-2-by- $M$  array, representing  $M$  2-port S-parameters. `z0` is the reference impedance  $Z_0$ ; its default is 50 ohms. `zs` is the source impedance  $Z_s$ ; its default is also 50 ohms. `coefficient` is an  $M$ -element complex vector.

`coefficient = gammaout(hs,zs)` calculates the output reflection coefficient of the 2-port network represented by the S-parameter object `hs`.

**Algorithms** The function calculates `coefficient` using the equation

$$\Gamma_{out} = S_{22} + \frac{S_{12}S_{21}\Gamma_S}{1 - S_{11}\Gamma_S}$$

where

$$\Gamma_S = \frac{Z_s - Z_0}{Z_s + Z_0}$$

**Examples** Calculate the output reflection coefficient using network data from a file:

```
ckt = read(rfckt.amplifier,'default.s2p');
s_params = ckt.NetworkData.Data;
z0 = ckt.NetworkData.Z0;
zs = 100;
coefficient = gammaout(s_params,z0,zs);
```

**See Also** `gamma2z` | `gammain` | `gammaml` | `gammams` | `vswr`

# getdata

---

**Purpose** Data object containing analyzed result of specified circuit object

**Syntax** `hd = getdata(h)`

**Description** `hd = getdata(h)` returns a handle, `hd`, to the `rfdata.data` object containing the analysis data, if any, for circuit (`rfckt`) object `h`. If there is no analysis data, `getdata` displays an error message.

---

**Note** Before calling `getdata`, use the `analyze` function to perform a frequency domain analysis for the circuit (`rfckt`) object. Perform this action for all circuit objects except `rfckt.amplifier`, `rfckt.datafile`, and `rfckt.mixer`. When you create an `rfckt.amplifier`, `rfckt.datafile`, or `rfckt.mixer` object by reading data from a file, RF Toolbox software automatically creates an `rfdata.data` object. RF Toolbox stores data from the file as properties of the data object. You can use the `getdata` function, without first calling `analyze`, to retrieve the handle of the `rfdata.data` object.

---

---

<b>Purpose</b>	Convert hybrid h-parameters to ABCD-parameters
<b>Syntax</b>	<code>abcd_params = h2abcd(h_params)</code>
<b>Description</b>	<code>abcd_params = h2abcd(h_params)</code> converts the hybrid parameters <code>h_params</code> into the ABCD-parameters <code>abcd_params</code> . The <code>h_params</code> input is a complex 2-by-2-by- $M$ array, representing $M$ 2-port hybrid h-parameters. <code>abcd_params</code> is a complex 2-by-2-by- $M$ array, representing $M$ 2-port ABCD-parameters.
<b>Alternatives</b>	You can also use network parameter objects to perform network parameter conversions. For more information, see “RF Network Parameter Objects” on page 2-12.
<b>Examples</b>	Convert h-parameters to ABCD-parameters:  <pre>%Define a matrix of h-parameters. h_11 =      0.314441556185771 +      2.51960941000598i; h_12 =      0.999823389146385 - 0.000246785162909241i; h_21 =      -1.000115600382660 - 0.000129304649930592i; h_22 = -6.55389515512306e-007 + 6.67541048071651e-006i; h_params = [h_11,h_12; h_21,h_22]; %Convert to ABCD-parameters abcd_params = h2abcd(h_params);</pre>
<b>See Also</b>	<code>abcd2h</code>   <code>h2s</code>   <code>h2y</code>   <code>h2z</code>   <code>s2abcd</code>   <code>y2abcd</code>   <code>z2abcd</code>

# h2g

---

**Purpose** Convert hybrid h-parameters to hybrid g-parameters

**Syntax** `g_params = h2g(h_params,z0)`

**Description** `g_params = h2g(h_params,z0)` converts the hybrid parameters `h_params` into the hybrid g-parameters `g_params`. The `h_params` input is a complex 2-by-2-by- $M$  array, representing  $M$  2-port h-parameters. `g_params` is a complex 2-by-2-by- $M$  array, representing  $M$  2-port g-parameters.

**Alternatives** You can also use network parameter objects to perform network parameter conversions. For more information, see “RF Network Parameter Objects” on page 2-12.

**Examples** Convert h-parameters to g-parameters:

```
%Define a matrix of h-parameters.  
h_11 = 0.314441556185771 + 2.51960941000598i;  
h_12 = 0.999823389146385 - 0.000246785162909241i;  
h_21 = -1.000115600382660 - 0.000129304649930592i;  
h_22 = -6.55389515512306e-007 + 6.67541048071651e-006i;  
h_params = [h_11,h_12; h_21,h_22];  
%Convert to g-parameters  
g_params = h2g(h_params);
```

**See Also** `g2h` | `h2abcd` | `h2s` | `h2y` | `h2z`

---

<b>Purpose</b>	Convert hybrid h-parameters to S-parameters
<b>Syntax</b>	<code>s_params = h2s(h_params,z0)</code>
<b>Description</b>	<code>s_params = h2s(h_params,z0)</code> converts the hybrid parameters <code>h_params</code> into the scattering parameters <code>s_params</code> . The <code>h_params</code> input is a complex 2-by-2-by- $M$ array, representing $M$ 2-port hybrid h-parameters. <code>z0</code> is the reference impedance; its default is 50 ohms. <code>s_params</code> is a complex 2-by-2-by- $M$ array, representing $M$ 2-port S-parameters.
<b>Alternatives</b>	You can also use network parameter objects to perform network parameter conversions. For more information, see “RF Network Parameter Objects” on page 2-12.
<b>Examples</b>	Convert h-parameters to S-parameters:  <pre>%Define a matrix of h-parameters. h_11 =      0.314441556185771 +      2.51960941000598i; h_12 =      0.999823389146385 - 0.000246785162909241i; h_21 =     -1.000115600382660 - 0.000129304649930592i; h_22 = -6.55389515512306e-007 + 6.67541048071651e-006i; h_params = [h_11,h_12; h_21,h_22]; %Convert to S-parameters s_params = h2s(h_params);</pre>
<b>See Also</b>	<code>abcd2s</code>   <code>h2abcd</code>   <code>h2y</code>   <code>h2z</code>   <code>y2s</code>   <code>z2s</code>

# h2y

---

**Purpose** Convert hybrid h-parameters to Y-parameters

**Syntax** `y_params = h2y(h_params)`

**Description** `y_params = h2y(h_params)` converts the hybrid parameters `h_params` into the admittance parameters `y_params`. The `h_params` input is a complex 2-by-2-by- $M$  array, representing  $M$  2-port hybrid h-parameters. `y_params` is a complex 2-by-2-by- $M$  array, representing  $M$  2-port Y-parameters.

**Alternatives** You can also use network parameter objects to perform network parameter conversions. For more information, see “RF Network Parameter Objects” on page 2-12.

**Examples** Convert h-parameters to Y-parameters:

```
%Define a matrix of h-parameters.  
h_11 = 0.314441556185771 + 2.51960941000598i;  
h_12 = 0.999823389146385 - 0.000246785162909241i;  
h_21 = -1.000115600382660 - 0.000129304649930592i;  
h_22 = -6.55389515512306e-007 + 6.67541048071651e-006i;  
h_params = [h_11,h_12; h_21,h_22];  
%Convert to Y-parameters  
y_params = h2y(h_params);
```

**See Also** `abcd2z` | `h2abcd` | `h2s` | `h2y` | `h2y` | `s2z` | `y2z` | `z2h`



---

<b>Purpose</b>	Convert hybrid h-parameters to Z-parameters
<b>Syntax</b>	<code>z_params = h2z(h_params)</code>
<b>Description</b>	<code>z_params = h2z(h_params)</code> converts the hybrid parameters <code>h_params</code> into the impedance parameters <code>z_params</code> . The <code>h_params</code> input is a complex 2-by-2-by- $M$ array, representing $M$ 2-port hybrid h-parameters. <code>z_params</code> is a complex 2-by-2-by- $M$ array, representing $M$ 2-port Z-parameters.
<b>Alternatives</b>	You can also use network parameter objects to perform network parameter conversions. For more information, see “RF Network Parameter Objects” on page 2-12.
<b>Examples</b>	Convert h-parameters to Z-parameters:  <pre>%Define a matrix of h-parameters. h_11 =      0.314441556185771 +      2.51960941000598i; h_12 =      0.999823389146385 - 0.000246785162909241i; h_21 =     -1.000115600382660 - 0.000129304649930592i; h_22 = -6.55389515512306e-007 + 6.67541048071651e-006i; h_params = [h_11,h_12; h_21,h_22]; %Convert to Z-parameters z_params = h2z(h_params);</pre>
<b>See Also</b>	<code>abcd2z</code>   <code>h2abcd</code>   <code>h2s</code>   <code>h2y</code>   <code>s2z</code>   <code>y2z</code>   <code>z2h</code>

# ispassive

---

## Purpose

Check passivity of N-port S-parameters

## Syntax

```
[flag,index_non_passive] = ispassive(s_params)
[flag,index_non_passive] = ispassive(hs)
```

## Description

[flag,index\_non\_passive] = ispassive(s\_params) checks the passivity of sparams, an array of N-port S-parameters. If all the S-parameters are passive, ispassive sets flag equal to 1 (true). Otherwise, flag is equal to 0 (false). index\_non\_passive is a vector of indices corresponding to the non-passive S-parameters in sparams. If flag is true, index\_non\_passive is empty.

[flag,index\_non\_passive] = ispassive(hs) checks the passivity of the network represented by the S-parameter object hs.

## Examples

Check the passivity of an S-parameters array; separate non-passive S-parameters into a new array:

```
%Read a Touchstone data file
ckt = read(rfckt.passive,'passive.s2p')
%Check the passivity
data = ckt.AnalyzedResult
[result,index] = ispassive(data.S_Parameters);
%Get the non-passive S-parameters
if ~(result)
    AllNonPassiveSparams = data.S_Parameters(:, :, index);
    FirstNonPassiveSparams = AllNonPassiveSparams(:, :, 1)
end
```

## See Also

rationalfit | rfmodel.rational.ispassive | s2tf | snp2smp

<b>Purpose</b>	Enforce passivity of S-parameters
<b>Syntax</b>	<pre>sparams_passive = makepassive(sparams) hsp = makepassive(hs)</pre>
<b>Description</b>	<p>sparams_passive = makepassive(sparams) makes an array of S-parameters passive. Both sparams and sparams_passive are N-by-N-by-M arrays representing M N-port S-parameters.</p> <p>The makepassive function enforces the following conditions on sparams:</p> $S(-j\omega) = S^*(j\omega)$ $\ S(j\omega)\ _2 \leq 1$ <p>The notation <math>\ S\ _2</math> represents the 2-norm, or singular-value decomposition, of S.</p> <p>hsp = makepassive(hs) creates a passive S-parameter object from the S-parameter object hs.</p>
<b>Input Arguments</b>	<p><b>hs</b> N-port S-parameters, specified as an RF Toolbox S-parameter object.</p> <p><b>sparams</b> sparams can represent either an active network or a passive network. To check if sparams is passive, use the ispassive function.</p>
<b>Output Arguments</b>	<p><b>sparams_passive</b> The makepassive function uses a purely mathematical method to calculate sparams_passive. As a result, the array sparams_passive does not represent the same network as sparams. sparams and sparams_passive do not represent the same network unless sparams and sparams_passive are equal.</p>

# makepassive

---

The more closely `sparams` represents a passive network, the better the approximation `sparams_passive` is to that network. Therefore, `makepassive` generates the most realistic results when `sparams` is active only due to small numerical errors.

## Examples

Enforce passivity of the S-parameters that represent a passive network:

```
ckt = read(rfckt.passive, 'passive.s2p');
sparams = ckt.NetworkData.Data;
Is_Passive = ispassive(sparams)
sparams_new = makepassive(sparams);
Is_Passive = ispassive(sparams_new)
ckt.NetworkData.Data = sparams_new;
```

## See Also

`ispassive`

**Purpose** Power gain of 2-port network

**Syntax**

```
g = powergain(s_params,z0,zs,zl,'Gt')
g = powergain(s_params,z0,zs,'Ga')
g = powergain(s_params,z0,zl,'Gp')
g = powergain(s_params,'Gmag')
g = powergain(s_params,'Gmsg')

g = powergain(hs,zs,zl,'Gt')
g = powergain(hs,zs,'Ga')
g = powergain(hs,zl,'Gp')
g = powergain(hs,'Gmag')
g = powergain(hs,'Gmsg')
```

**Description** `g = powergain(s_params,z0,zs,zl,'Gt')` calculates the transducer power gain of the 2-port network `s_params`.

`g = powergain(s_params,z0,zs,'Ga')` calculates the available power gain of the 2-port network.

`g = powergain(s_params,z0,zl,'Gp')` calculates the operating power gain of the 2-port network.

`g = powergain(s_params,'Gmag')` calculates the maximum available power gain of the 2-port network.

`g = powergain(s_params,'Gmsg')` calculates the maximum stable gain of the 2-port network.

`g = powergain(hs,zs,zl,'Gt')` calculates the transducer power gain of the network represented by the S-parameter object `hs`.

`g = powergain(hs,zs,'Ga')` calculates the available power gain of the network represented by the S-parameter object `hs`.

`g = powergain(hs, z1, 'Gp')` calculates the operating power gain of the network represented by the S-parameter object `hs`.

`g = powergain(hs, 'Gmag')` calculates the maximum available power gain of the network represented by the S-parameter object `hs`.

`g = powergain(hs, 'Gmsg')` calculates the maximum stable gain of the network represented by the S-parameter object `hs`.

## Input Arguments

### **hs - 2-port S-parameters**

S-parameter object

2-port S-parameters, specified as an RF Toolbox S-parameter object.

### **s\_params - 2-port S-parameters**

array of complex numbers

2-port S-parameters, specified as a complex 2-by-2-by- $N$  array.

### **z0 - Reference impedance**

positive scalar | 50 (default)

Reference impedance in ohms, specified as a positive scalar. If the first input argument is an S-parameter object `hs`, the function uses `hs.Impedance` for the reference impedance.

### **z1 - Load impedance**

positive scalar | 50 (default)

Load impedance in ohms, specified as a positive scalar.

### **zs - Source impedance**

positive scalar | 50 (default)

Source impedance in ohms, specified as a positive scalar.

**Output Arguments****g - Power gain**

vector

Unitless power gain values, returned as a vector. To obtain power gain in decibels, use  $10 \cdot \log_{10}(g)$ .

If the specified type of power gain is undefined for one or more of the specified S-parameter values in `s_params`, the `powergain` function returns NaN. As a result, `g` is either NaN or a vector that contains one or more NaN entries.

**Examples**

Calculate power gains for a sample 2-port network:

```
s11 = 0.61*exp(j*165/180*pi);
s21 = 3.72*exp(j*59/180*pi);
s12 = 0.05*exp(j*42/180*pi);
s22 = 0.45*exp(j*(-48/180)*pi);
sparam = [s11 s12; s21 s22];
z0 = 50;
zs = 10 + j*20;
z1 = 30 - j*40;
%Calculate the transducer power gain of the network
Gt = powergain(sparam,z0,zs,z1,'Gt')
%Calculate the available power gain of the network
Ga = powergain(sparam,z0,zs,'Ga')
%Calculate the operating power gain of the network
Gp = powergain(sparam,z0,z1,'Gp')
%Calculate the maximum available power gain of the network
Gmag = powergain(sparam,'Gmag')
%Calculate the maximum stable power gain of the network
Gmsg = powergain(sparam,'Gmsg')
```

**See Also**

s2tf

# rationalfit

---

**Purpose** Approximate data using stable rational function

**Syntax**  
`h = rationalfit(freq,data)`  
`h = rationalfit(freq,data,tol)`  
`h = rationalfit(___,Name,Value)`

**Description** `h = rationalfit(freq,data)` fits a rational function model of the form

$$F(s) = \sum_{k=1}^n \frac{C_k}{s - A_k} + D, \quad s = j \cdot 2\pi f$$

to the complex vector `data` over the frequency values in the positive vector `freq`. The function returns a handle to the rational function model object, `h`, with properties `A`, `C`, `D`, and `Delay`.

`h = rationalfit(freq,data,tol)` fits a rational function model to complex data and constrains the error of the fit according to the optional input argument `tol`.

`h = rationalfit(___,Name,Value)` fits a rational function with additional options specified by one or more `Name,Value` pair arguments. These arguments offer finer control over the performance and accuracy of the fitting algorithm.

## Examples **Stable rational-function approximation of S-parameter data**

Fit a rational function model to S-parameter data, and compare the results by plotting the model against the data.

1

Read the S-parameter data into an RF data object.

```
orig_data = read(rfdata.data, 'passive.s2p');  
freq = orig_data.Freq;  
data = orig_data.S_Parameters(1,1,:);
```



**2**

Fit a rational function to the data using `rationalfit`.

```
fit_data = rationalfit(freq,data);
```

**3**

Compute the frequency response of the rational function using `freqresp`.

```
[resp,freq] = freqresp(fit_data,freq);
```

**4**

Plot the magnitude of the original data against the rational function approximation.  $S_{11}$  data appears in blue, and the rational function appears in red. Scaling the frequency values by  $1e9$  converts them to units of GHz.

```
figure;  
title('Rational fitting of S11 magnitude')  
plot(orig_data,'S11','dB');  
hold on;  
plot(freq/1e9,db(resp),'r');
```

**5**

Plot the angle of the original data against the rational function approximation.

```
figure;  
title('Rational fitting of S11 angle')  
plot(orig_data,'S11','Angle (radians)');  
hold on;  
plot(freq/1e9,unwrap(angle(resp)),'r');
```

## Tips

To see how well the model fits the original data, use the `freqresp` function to compute the frequency response of the model. Then, plot the original data and the frequency response of the rational function model. For more information, see the `freqresp` reference page or the examples in the next section.

## Input Arguments

### **freq** - Frequencies

vector of positive numbers

Frequencies over which the function fits a rational model, specified as a vector of length  $M$ .

### **data** - Data to fit

vector of complex numbers |  $N$ -by- $N$ -by- $M$  array of complex numbers

Data to be approximated, specified as an  $N$ -by- $N$ -by- $M$  array of complex numbers. The function fits  $N^2$  rational functions to the data along the  $M$  (frequency) dimension.

### **tol** - Error tolerance

-40 (default) | scalar

Error tolerance  $\varepsilon$ , specified as a scalar in units of dB.. The error-fitting equation is

$$10^{\varepsilon/20} \geq \frac{\sqrt{\sum_{k=1}^n |F_0\{f_k\} - F(s)|^2}}{\sqrt{\sum_{k=1}^n |F_0\{f_k\}|^2}}$$

where

- $\varepsilon$  is the specified value of `tol`.
- $F_0$  is the value of the original data (`data`) at the specified frequency  $f_k$  (`freq`).
- $F$  is the value of the rational function at  $s = j2\pi f$ .

`rationalfit` computes the relative error as a vector containing the dependent values of the fit data. If the model does not fit the original data within the specified tolerance, a warning message appears.

**Default:** -40

### **Name-Value Pair Arguments**

Specify optional comma-separated pairs of `Name`, `Value` arguments, where `Name` is the argument name and `Value` is the corresponding value. `Name` must appear inside single quotes ( ' '). You can specify several name and value pair arguments in any order as `Name1, Value1, ..., NameN, ValueN`.

#### **DelayFactor - Delay factor**

scalar from 0 to 1 | 0 (default)

Scaling factor that controls the amount of delay to fit to the data, specified as the comma-separated pair consisting of 'DelayFactor' and a scalar between 0 and 1 inclusive. The `Delay` parameter,  $\tau$ , of the rational function object is equal to the specified value of 'DelayFactor' times an estimate of the group delay of the data. If the original data has delay, increasing this value might allow `rationalfit` to fit the data with a lower-order model.

#### **IterationLimit - Maximum number of iterations**

integer | 12 (default)

Number of vector-fitting iterations performed during pole search, specified as the comma-separated pair consisting of 'IterationLimit' and a positive integer. Increasing the limit extends the time that the algorithm takes to produce a fit, but may produce more accurate results.

#### **NPoles - Number of poles**

[0 48] (default) | nonnegative integer | vector of two nonnegative integers

Number of poles  $A_k$  of the rational function, specified as the comma-separated pair consisting of 'NPoles' and an integer  $n$  or range of possible values of  $n$ .

To help `rationalfit` produce an accurate fit, choose a maximum value of `npoles` greater than or equal to twice the number of peaks on a plot of the data in the frequency domain.

After completing a rational fit, the function removes coefficient sets whose residues ( $C_k$ ) are zero. Thus, when you specify a range for `npoles`, the number of poles of the fit may be less than `npoles(1)`.

### **TendsToZero - Asymptotic behavior of fit**

true (default) | false

Asymptotic behavior of the rational function as frequency approaches infinity, specified as the comma-separated pair consisting of 'TendsToZero' and a logical value. When this argument is true, the resulting rational function variable  $D$  is zero, and the function tends to zero. A value of false allows a nonzero value for  $D$ .

### **Tolerance - Error tolerance**

-40 (default) | scalar

Error tolerance  $\varepsilon$ , specified as the comma-separated pair consisting of 'Tolerance' and a scalar in units of dB. The error-fitting equation is

$$10^{\varepsilon/20} \geq \frac{\sqrt{\sum_{k=1}^n |F_0(f_k) - F(s)|^2}}{\sqrt{\sum_{k=1}^n |F_0(f_k)|^2}}$$

where

- $\varepsilon$  is the specified tolerance.
- $F_0$  is the value of the original data (`data`) at the specified frequency  $f_k$  (`freq`).

- $F$  is the value of the rational function at  $s = j2\pi f$ .

If the model does not fit the original data within the specified tolerance, the function throws a warning.

### WaitBar - Graphical wait bar

true | false (default)

Logical value that toggles display of the graphical wait bar during fitting, specified as the comma-separated pair consisting of 'WaitBar' and either true or false. The true setting shows the graphical wait bar, and the false setting hides it. If you expect rationalfit to take a long time, and you want to monitor its progress, set 'WaitBar' to true.

### Weight - Weighting of data

ones(size(freq)) (default) | vector of positive numbers

Weighting of the data at each frequency, specified as the comma-separated pair consisting of 'Weight' and a vector of positive numbers. Each entry in weight corresponds to a frequency in freq, so the length of weight must be equal to the length of freq. Increasing the weight at a particular frequency improves the model fitting at that frequency. Specifying a weight of 0 at a particular frequency causes rationalfit to ignore the corresponding data point.

## Output Arguments

### h - Rational model object

rfmodel.rational object

One or more rational models, returned as an  $N$ -by- $N$  rfmodel.rational object. The number of dimensions in data determines the dimensionality of h.

## References

B. Gustavsen and A. Semlyen, "Rational approximation of frequency domain responses by vector fitting," IEEE Trans. Power Delivery, Vol. 14, No. 3, pp. 1052–1061, July 1999.

R. Zeng and J. Sinsky, "Modified Rational Function Modeling Technique for High Speed Circuits," IEEE MTT-S Int. Microwave Symp. Dig., San Francisco, CA, June 11–16, 2006.

# rationalfit

---

## **See Also**

`freqresp` | `rfmodel.rational` | `s2tf` | `timeresp` | `writeva`

**Purpose** Open RF Analysis Tool (RF Tool)

**Syntax** `rftool`

**Description** `rftool` opens the RF Tool interface. Use this tool to:

- Create circuit components and set their parameters.
- Analyze components over a specified frequency range and step size.
- Plot the analysis results.
- Import component objects to and export them from the MATLAB workspace.
- Save RF Tool sessions for later use.

For more information, see “RF Tool” on page 5-2.

The following figure shows the RF Tool in its default state.

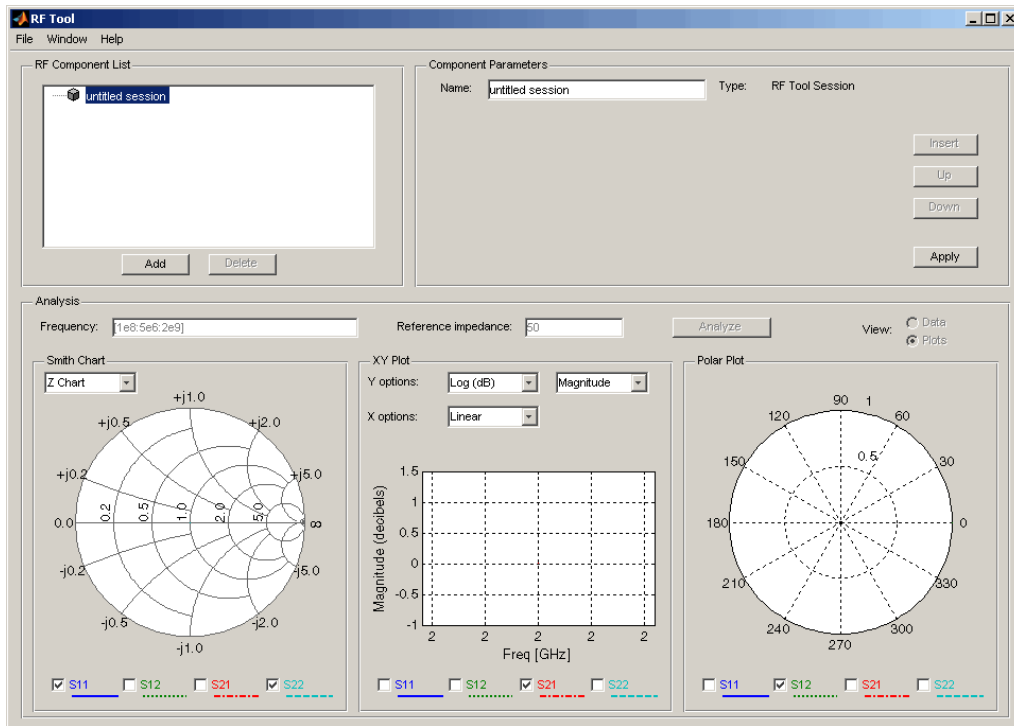



---

<b>Purpose</b>	Convert RLGC transmission line parameters to S-parameters
<b>Syntax</b>	<pre>s_params = rlgc2s(R,L,G,C,length,freq,z0) s_params = rlgc2s(R,L,G,C,length,freq)</pre>
<b>Description</b>	<p><code>s_params = rlgc2s(R,L,G,C,length,freq,z0)</code> transforms RLGC transmission line parameter data into S-parameters.</p> <p><code>s_params = rlgc2s(R,L,G,C,length,freq)</code> transforms RLGC transmission line parameter data into S-parameters with a reference impedance of <math>50\ \Omega</math>.</p>
<b>Input Arguments</b>	<p><b>R</b></p> <p>Specify an <math>N</math>-by-<math>N</math>-by-<math>M</math> array of distributed resistances, in units of <math>\Omega/\text{m}</math>. The <math>N</math>-by-<math>N</math> matrices must be real symmetric, the diagonal terms must be nonnegative, and the off-diagonal terms must be nonnegative.</p> <p><b>L</b></p> <p>Specify an <math>N</math>-by-<math>N</math>-by-<math>M</math> array of distributed inductances, in units of <math>\text{H}/\text{m}</math>. The <math>N</math>-by-<math>N</math> matrices must be real symmetric, the diagonal terms must be positive, and the off-diagonal terms must be nonnegative.</p> <p><b>G</b></p> <p>Specify an <math>N</math>-by-<math>N</math>-by-<math>M</math> array of distributed conductances, in units of <math>\text{S}/\text{m}</math>. The <math>N</math>-by-<math>N</math> matrices must be real symmetric, the diagonal terms must be nonnegative, and the off-diagonal terms must be nonpositive.</p> <p><b>C</b></p> <p>Specify an <math>N</math>-by-<math>N</math>-by-<math>M</math> array of distributed capacitances, in units of <math>\text{F}/\text{m}</math>. The matrices must be real symmetric, the diagonal terms must be positive, and the off-diagonal terms must be nonpositive.</p> <p><b>length</b></p> <p>Specify the length of the transmission line in meters.</p>

## freq

Specify the vector of  $M$  frequencies over which the transmission line parameters are defined.

## z0

Specify the reference impedance of the resulting S-parameters in ohms.

**Default:** 50

## Output Arguments

### s\_params

The output is a  $2N$ -by- $2N$ -by- $M$  array of S-parameters. The following figure describes the port ordering convention of the output.



$$\begin{bmatrix} S_{11} & S_{12} & S_{13} & S_{14} \\ S_{21} & S_{22} & S_{23} & S_{24} \\ S_{31} & S_{32} & S_{33} & S_{34} \\ S_{41} & S_{42} & S_{43} & S_{44} \end{bmatrix}$$

This port ordering convention assumes that:

- Each  $2N$ -by- $2N$  matrix consists of  $N$  input terminals and  $N$  output terminals.
- The first  $N$  ports (1 through  $N$ ) of the S-parameter matrix are input ports.
- The last  $N$  ports ( $N + 1$  through  $2N$ ) are output ports.

To reorder ports after using this function, use the `snp2smp` function.

## Definitions

The following figure illustrates the RLGC transmission line model.

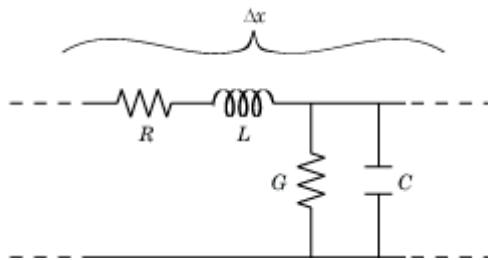

The representation consists of:

- The distributed resistance,  $R$ , of the conductors, represented by a series resistor.
- The distributed inductance,  $L$ , represented by a series inductor.
- The distributed conductance,  $G$ ,
- The distributed capacitance,  $C$ , between the two conductors, represented by a shunt capacitor.

RLGC component units are all per unit length  $\Delta x$ .

## Examples

Convert RLGC transmission line parameters into S-parameters:

```
%Define transmission line variables
length = 1e-3;
freq = 1e9;
z0 = 50;
R = 50;
L = 1e-9;
G = .01;
C = 1e-12;
% Calculate S-parameters
s_params = rlgc2s(R,L,G,C,length,freq,z0)
```

## References

Bhatti, A. Aziz. "A computer Based Method for Computing the N-Dimensional Generalized ABCD Parameter Matrices of N-Dimensional Systems with Distributed Parameters." *Southeastern*

*Symposium on System Theory*. SSST, 22nd Conference, 11–13 March 1990, pp. 590–593.

**See Also**

s2rlgc

**Purpose** Convert S-parameters to ABCD-parameters

**Syntax** `abcd_params = s2abcd(s_params, z0)`

**Description** `abcd_params = s2abcd(s_params, z0)` converts the scattering parameters `s_params` into the ABCD-parameters `abcd_params`. The `s_params` input is a complex  $2N$ -by- $2N$ -by- $M$  array, representing  $M$   $2N$ -port S-parameters. `z0` is the reference impedance; its default is 50 ohms. `abcd_params` is a complex  $2N$ -by- $2N$ -by- $M$  array, representing  $M$  2-port ABCD-parameters. The output ABCD-parameter matrices have distinct  $A$ ,  $B$ ,  $C$ , and  $D$  submatrices:

$$\begin{bmatrix} [A] & [B] \\ [C] & [D] \end{bmatrix}$$

**Alternatives** You can also use network parameter objects to perform network parameter conversions. For more information, see “RF Network Parameter Objects” on page 2-12.

**Examples** Convert S-parameters to ABCD-parameters:

```
%Define a matrix of S-parameters
s_11 = 0.61*exp(j*165/180*pi);
s_21 = 3.72*exp(j*59/180*pi);
s_12 = 0.05*exp(j*42/180*pi);
s_22 = 0.45*exp(j*(-48/180)*pi);
s_params = [s_11 s_12; s_21 s_22];
z0 = 50;
%Convert to ABCD-parameters
abcd_params = s2abcd(s_params, z0)
```

**See Also** `abcd2s` | `h2abcd` | `s2h` | `s2y` | `s2z` | `y2abcd` | `z2abcd`

# s2h

---

**Purpose** Convert S-parameters to hybrid h-parameters

**Syntax** `h_params = s2h(s_params,z0)`

**Description** `h_params = s2h(s_params,z0)` converts the scattering parameters `s_params` into the hybrid parameters `h_params`. The `s_params` input is a complex 2-by-2-by- $M$  array, representing  $M$  2-port S-parameters. `z0` is the reference impedance; its default is 50 ohms. `h_params` is a complex 2-by-2-by- $M$  array, representing  $M$  2-port hybrid h-parameters.

**Alternatives** You can also use network parameter objects to perform network parameter conversions. For more information, see “RF Network Parameter Objects” on page 2-12.

**Examples** Convert S-parameters to h-parameters:

```
%Define a matrix of S-parameters
s_11 = 0.61*exp(j*165/180*pi);
s_21 = 3.72*exp(j*59/180*pi);
s_12 = 0.05*exp(j*42/180*pi);
s_22 = 0.45*exp(j*(-48/180)*pi);
s_params = [s_11 s_12; s_21 s_22];
z0 = 50;
%Convert to h-parameters
h_params = s2h(s_params,z0)
```

**See Also** `h2s`

**Purpose**

Convert S-parameters to RLGC transmission line parameters

**Syntax**

```
rlgc_params = s2rlgc(s_params,length,freq,z0)
rlgc_params = s2rlgc(s_params,length,freq)
```

**Description**

`rlgc_params = s2rlgc(s_params,length,freq,z0)` transforms multi-port S-parameter data into a frequency-domain representation of an RLGC transmission line.

`rlgc_params = s2rlgc(s_params,length,freq)` transforms multi-port S-parameter data into RLGC transmission line parameters using a reference impedance of  $50 \Omega$ .

**Input Arguments****s\_params**

Specify a  $2N$ -by- $2N$ -by- $M$  array of S-parameters to transform into RLGC transmission line parameters. The following figure describes the port ordering convention assumed by the function.



$$\begin{bmatrix} S_{11} & S_{12} & S_{13} & S_{14} \\ S_{21} & S_{22} & S_{23} & S_{24} \\ S_{31} & S_{32} & S_{33} & S_{34} \\ S_{41} & S_{42} & S_{43} & S_{44} \end{bmatrix}$$

The function assumes that:

- Each  $2N$ -by- $2N$  matrix consists of  $N$  input terminals and  $N$  output terminals.
- The first  $N$  ports (1 through  $N$ ) of the S-parameter matrix are input ports.
- The last  $N$  ports ( $N + 1$  through  $2N$ ) are output ports.

To reorder ports before using this function, use the `snp2smp` function.

**length**

Specify the length of the transmission line in meters.

## **freq**

Specify the vector of  $M$  frequencies over which the S-parameter array `s_params` is defined.

## **z0**

Specify the reference impedance of the S-parameters in ohms.

**Default:** 50

## **Output Arguments**

### **rlgc\_params**

The output `rlgc_params` is structure whose fields are  $N$ -by- $N$ -by- $M$  arrays of transmission line parameters. Each of the  $M$   $N$ -by- $N$  matrices correspond to a frequency in the input vector `freq`.

- `rlgc_params.R` is an array of distributed resistances, in units of  $\Omega/m$ . The matrices are real symmetric, the diagonal terms are nonnegative, and the off-diagonal terms are nonnegative.
- `rlgc_params.L` is an array of distributed inductances, in units of  $H/m$ . The matrices are real symmetric, the diagonal terms are positive, and the off-diagonal terms are nonnegative.
- `rlgc_params.G` is an array of distributed conductances, in units of  $S/m$ . The matrices are real symmetric, the diagonal terms are nonnegative, and the off-diagonal terms are nonpositive.
- `rlgc_params.C` is an array of distributed capacitances, in units of  $F/m$ . The matrices are real symmetric, the diagonal terms are positive, and the off-diagonal terms are nonpositive.
- `rlgc_params.Zc` is an array of complex characteristic line impedances, in ohms.
- `rlgc_params.alpha` is an array of real attenuation coefficients, in units of  $Np/m$ .



- `rlgc_params.beta` is an array of real phase constants, in units of rad/m.

## Definitions

The following figure illustrates the RLGC transmission line model.

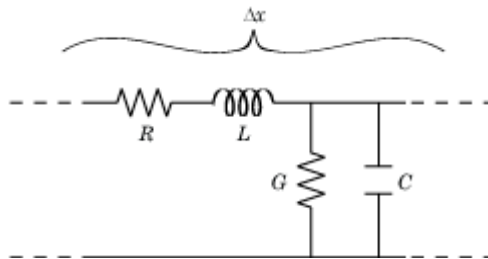

The representation consists of:

- The distributed resistance,  $R$ , of the conductors, represented by a series resistor.
- The distributed inductance,  $L$ , of the conductors, represented by a series inductor.
- The distributed conductance,  $G$ , between the two conductors, represented by a shunt resistor.
- The distributed capacitance,  $C$ , between the two conductors, represented by a shunt capacitor.

RLGC component units are all per unit length  $\Delta x$ .

## Examples

Convert S-parameters to RLGC transmission line parameters:

```
s_11 = 0.000249791883190134 - 9.42320545953709e-005i;
s_12 = 0.999250283783862 - 0.000219770154524734i;
s_21 = 0.999250283783863 - 0.000219770154524756i;
s_22 = 0.000249791883190079 - 9.42320545953931e-005i;
s_params = [s_11,s_12; s_21,s_22];
length = 1e-3;
freq = 1e9;
z0 = 50;
```

```
rlgc_params = s2rlgc(s_params,length,freq,z0)
```

## References

Degerstrom, M.J., B.K. Gilbert, and E.S. Daniel. “Accurate resistance, inductance, capacitance, and conductance (RLCG) from uniform transmission line measurements.” *Electrical Performance of Electronic Packaging*,. IEEE-EPEP, 18th Conference, 27–29 October 2008, pp. 77–80.

Sampath, M.K. “On addressing the practical issues in the extraction of RLGC parameters for lossy multiconductor transmission lines using S-parameter models.” *Electrical Performance of Electronic Packaging*,. IEEE-EPEP, 18th Conference, 27–29 October 2008, pp. 259–262.

## See Also

rlgc2s

---

<b>Purpose</b>	Convert S-parameters to S-parameters with different impedance
<b>Syntax</b>	<pre>s_params_new = s2s(s_params,z0) s_params_new = s2s(s_params,z0,z0_new)</pre>
<b>Description</b>	<p><code>s_params_new = s2s(s_params,z0)</code> converts the scattering parameters <code>s_params</code> with reference impedance <code>z0</code> into the scattering parameters <code>s_params_new</code> with a default reference impedance of 50 ohms. Both <code>s_params</code> and <code>s_params_new</code> are complex <math>N</math>-by-<math>N</math>-by-<math>M</math> arrays, representing <math>M</math> <math>N</math>-port S-parameters.</p> <p><code>s_params_new = s2s(s_params,z0,z0_new)</code> converts the scattering parameters <code>s_params</code> with reference impedance <code>z0</code> into the scattering parameters <code>s_params_new</code> with reference impedance <code>z0_new</code>.</p>
<b>Alternatives</b>	The <code>newref</code> function changes the reference impedance of S-parameters objects.
<b>Examples</b>	<p>Convert S-parameters from one reference impedance to another reference impedance:</p> <pre>%Define a matrix of S-parameters s_11 = 0.61*exp(j*165/180*pi); s_21 = 3.72*exp(j*59/180*pi); s_12 = 0.05*exp(j*42/180*pi); s_22 = 0.45*exp(j*(-48/180)*pi); s_params = [s_11 s_12; s_21 s_22]; z0 = 50; z0_new = 40; %Convert to new reference impedance s_params_new = s2s(s_params,z0,z0_new)</pre>
<b>See Also</b>	<code>abcd2s</code>   <code>h2s</code>   <code>s2abcd</code>   <code>s2h</code>   <code>s2y</code>   <code>s2z</code>   <code>y2s</code>   <code>z2s</code>

**Purpose** Convert single-ended S-parameters to common-mode S-parameters ( $S_{cc}$ )

**Syntax**  
`scc_params = s2scc(s_params)`  
`scc_params = s2scc(s_params,option)`

**Description** `scc_params = s2scc(s_params)` converts the  $2N$ -port, single-ended S-parameters, `s_params`, to  $N$ -port, common-mode S-parameters, `scc_params`. `scc_params` is a complex  $N$ -by- $N$ -by- $M$  array that represents  $M$   $N$ -port, common-mode S-parameters ( $S_{cc}$ ).

`scc_params = s2scc(s_params,option)` converts S-parameters based on the optional `option` argument, which indicates the port-ordering convention of the S-parameters.

## Input Arguments

### **s\_params**

`s_params` is a complex 4-by-4-by- $M$  array that represents  $M$  4-port S-parameters.

### **option**

1 (default) | 2 | 3

`option` determines how the function orders the ports:

- 1 — `s2scc` pairs the odd-numbered ports together first, followed by the even-numbered ports. For example, in a single-ended, 8-port network:
  - Ports 1 and 3 become common-mode pair 1.
  - Ports 5 and 7 become common-mode pair 2.
  - Ports 2 and 4 become common-mode pair 3.
  - Ports 6 and 8 become common-mode pair 4.

The following figure illustrates this convention for an 8-port device.

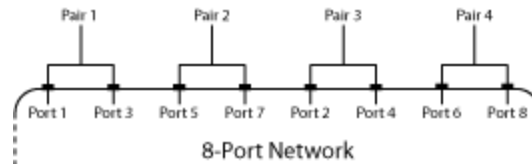

- 2 — s2scc pairs the input and output ports in ascending order. For example, in a single-ended, 8-port network:
  - Ports 1 and 2 become common-mode pair 1.
  - Ports 3 and 4 become common-mode pair 2.
  - Ports 5 and 6 become common-mode pair 3.
  - Ports 7 and 8 become common-mode pair 4.

The following figure illustrates this convention for an 8-port device.

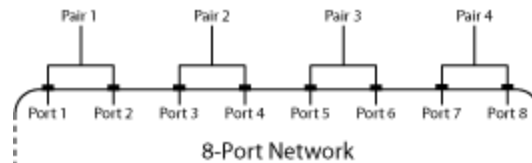

- 3 — s2scc pairs the input ports in ascending order and the output ports in descending order. For example, in a single-ended, 8-port network:
  - Ports 1 and 2 become common-mode pair 1.
  - Ports 3 and 4 become common-mode pair 2.
  - Ports 8 and 7 become common-mode pair 3.
  - Ports 6 and 5 become common-mode pair 4.

The following figure illustrates this convention for an 8-port device.

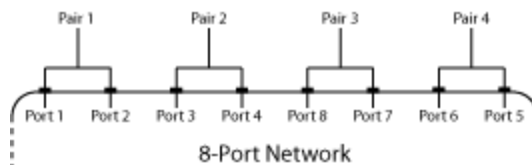

## Examples

Convert network data to common-mode S-parameters using the default port ordering:

```
ckt = read(rfckt.passive, 'default.s4p');  
s4p = ckt.NetworkData.Data;  
s_cc = s2scc(s4p);
```

## References

Fan, W., A. C. W. Lu, L. L. Wai, and B. K. Lok. “Mixed-Mode S-Parameter Characterization of Differential Structures.” *Electronic Packaging Technology Conference*, pp. 533–537, 2003.

## See Also

s2scd | s2sdc | s2sdd | s2smm | smm2s

<b>Purpose</b>	Convert 4-port, single-ended S-parameters to 2-port, cross-mode S-parameters ( $S_{cd}$ )
<b>Syntax</b>	<pre>scd_params = s2scd(s_params) scd_params = s2scd(s_params,option)</pre>
<b>Description</b>	<p><code>scd_params = s2scd(s_params)</code> converts the <math>2N</math>-port, single-ended S-parameters, <code>s_params</code>, to <math>N</math>-port, cross-mode S-parameters, <code>scd_params</code>. <code>scd_params</code> is a complex <math>N</math>-by-<math>N</math>-by-<math>M</math> array that represents <math>M</math> <math>N</math>-port, cross-mode S-parameters (<math>S_{cd}</math>).</p> <p><code>scd_params = s2scd(s_params,option)</code> converts S-parameters based on the optional <code>option</code> argument, which indicates the port-ordering convention of the S-parameters.</p>
<b>Input Arguments</b>	<p><b>s_params</b></p> <p><code>s_params</code> is a complex <math>2N</math>-by-<math>2N</math>-by-<math>M</math> array that represents <math>M</math> <math>2N</math>-port S-parameters.</p> <p><b>option</b></p> <p>1 (default)   2   3</p> <p><code>option</code> determines how the function orders the ports:</p> <ul style="list-style-type: none"> <li>• 1 — <code>s2scd</code> pairs the odd-numbered ports together first, followed by the even-numbered ports. For example, in a single-ended, 8-port network: <ul style="list-style-type: none"> <li>▪ Ports 1 and 3 become cross-mode pair 1.</li> <li>▪ Ports 5 and 7 become cross-mode pair 2.</li> <li>▪ Ports 2 and 4 become cross-mode pair 3.</li> <li>▪ Ports 6 and 8 become cross-mode pair 4.</li> </ul> </li> </ul> <p>The following figure illustrates this convention for an 8-port device.</p>

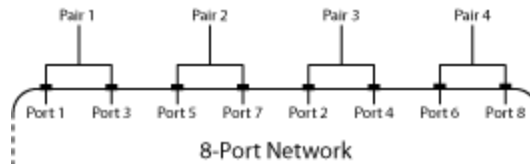

- 2 — s2scd pairs the input and output ports in ascending order. For example, in a single-ended, 8-port network:
  - Ports 1 and 2 become cross-mode pair 1.
  - Ports 3 and 4 become cross-mode pair 2.
  - Ports 5 and 6 become cross-mode pair 3.
  - Ports 7 and 8 become cross-mode pair 4.

The following figure illustrates this convention for an 8-port device.

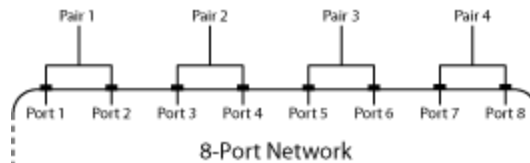

- 3 — s2scd pairs the input ports in ascending order and the output ports in descending order. For example, in a single-ended, 8-port network:
  - Ports 1 and 2 become cross-mode pair 1.
  - Ports 3 and 4 become cross-mode pair 2.
  - Ports 8 and 7 become cross-mode pair 3.
  - Ports 6 and 5 become cross-mode pair 4.

The following figure illustrates this convention for an 8-port device.



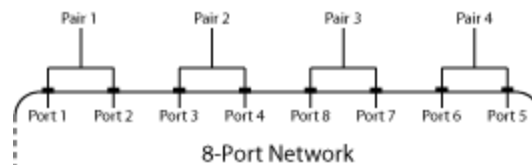

## Examples

Convert network data to cross-mode S-parameters using the default port ordering:

```
ckt = read(rfckt.passive, 'default.s4p');  
s4p = ckt.NetworkData.Data;  
s_cd = s2scd(s4p);
```

## References

Fan, W., A. C. W. Lu, L. L. Wai, and B. K. Lok. "Mixed-Mode S-Parameter Characterization of Differential Structures." Electronic Packaging Technology Conference, pp. 533–537, 2003.

## See Also

s2scc | s2sdc | s2sdd | s2smm | smm2s

**Purpose** Convert 4-port, single-ended S-parameters to 2-port, cross-mode S-parameters ( $S_{dc}$ )

**Syntax**  
`sdc_params = s2sdc(s_params)`  
`sdc_params = s2sdc(s_params,option)`

**Description** `sdc_params = s2sdc(s_params)` converts the  $2N$ -port, single-ended S-parameters, `s_params`, to  $N$ -port, cross-mode S-parameters, `sdc_params`. `sdc_params` is a complex  $N$ -by- $N$ -by- $M$  array that represents  $M$   $N$ -port, cross-mode S-parameters ( $S_{dc}$ ).

`sdc_params = s2sdc(s_params,option)` converts S-parameters based on the optional `option` argument, which indicates the port-ordering convention of the S-parameters.

## Input Arguments

### **s\_params**

`s_params` is a complex  $2N$ -by- $2N$ -by- $M$  array that represents  $M$   $2N$ -port S-parameters.

### **option**

1 (default) | 2 | 3

`option` determines how the function orders the ports:

- 1 — `s2sdc` pairs the odd-numbered ports together first, followed by the even-numbered ports. For example, in a single-ended, 8-port network:
  - Ports 1 and 3 become cross-mode pair 1.
  - Ports 5 and 7 become cross-mode pair 2.
  - Ports 2 and 4 become cross-mode pair 3.
  - Ports 6 and 8 become cross-mode pair 4.

The following figure illustrates this convention for an 8-port device.

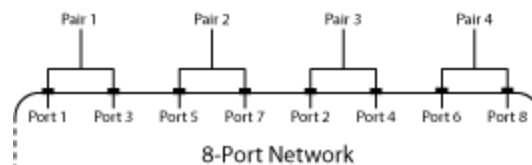

- 2 — s2sdc pairs the input and output ports in ascending order. For example, in a single-ended, 8-port network:
  - Ports 1 and 2 become cross-mode pair 1.
  - Ports 3 and 4 become cross-mode pair 2.
  - Ports 5 and 6 become cross-mode pair 3.
  - Ports 7 and 8 become cross-mode pair 4.

The following figure illustrates this convention for an 8-port device.

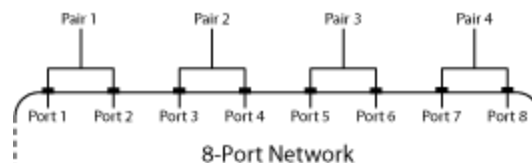

- 3 — s2sdc pairs the input ports in ascending order and the output ports in descending order. For example, in a single-ended, 8-port network:
  - Ports 1 and 2 become cross-mode pair 1.
  - Ports 3 and 4 become cross-mode pair 2.
  - Ports 8 and 7 become cross-mode pair 3.
  - Ports 6 and 5 become cross-mode pair 4.

The following figure illustrates this convention for an 8-port device.

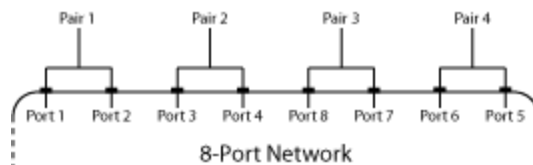

## Examples

Convert network data to cross-mode S-parameters using the default port ordering:

```
ckt = read(rfckt.passive, 'default.s4p');  
s4p = ckt.NetworkData.Data;  
s_dc = s2sdc(s4p);
```

## References

Fan, W., A. C. W. Lu, L. L. Wai, and B. K. Lok. “Mixed-Mode S-Parameter Characterization of Differential Structures.” *Electronic Packaging Technology Conference*, pp. 533–537, 2003.

## See Also

s2scc | s2scd | s2sdd | s2smm | smm2s

**Purpose** Convert 4-port, single-ended S-parameters to 2-port, differential-mode S-parameters ( $S_{dd}$ )

**Syntax**

```
sdd_params = s2sdd(s_params)
sdd_params = s2sdd(s_params,option)
```

**Description**

`sdd_params = s2sdd(s_params)` converts the  $2N$ -port, single-ended S-parameters, `s_params`, to  $N$ -port, differential-mode S-parameters, `sdd_params`. `sdd_params` is a complex  $N$ -by- $N$ -by- $M$  array that represents  $M$   $N$ -port, differential-mode S-parameters ( $S_{cd}$ ).

`sdd_params = s2sdd(s_params,option)` converts S-parameters based on the optional `option` argument, which indicates the port-ordering convention of the S-parameters.

## Input Arguments

### **s\_params**

`s_params` is a complex  $2N$ -by- $2N$ -by- $M$  array that represents  $M$   $2N$ -port S-parameters.

### **option**

1 (default) | 2 | 3

`option` determines how the function orders the ports:

- 1 — `s2sdd` pairs the odd-numbered ports together first, followed by the even-numbered ports. For example, in a single-ended, 8-port network:
  - Ports 1 and 3 become differential-mode pair 1.
  - Ports 5 and 7 become differential-mode pair 2.
  - Ports 2 and 4 become differential-mode pair 3.
  - Ports 6 and 8 become differential-mode pair 4.

The following figure illustrates this convention for an 8-port device.

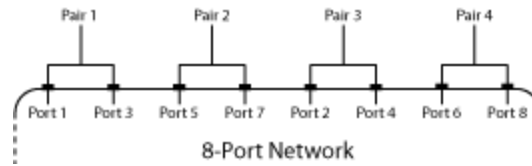

- 2 — s2sdd pairs the input and output ports in ascending order. For example, in a single-ended, 8-port network:
  - Ports 1 and 2 become differential-mode pair 1.
  - Ports 3 and 4 become differential-mode pair 2.
  - Ports 5 and 6 become differential-mode pair 3.
  - Ports 7 and 8 become differential-mode pair 4.

The following figure illustrates this convention for an 8-port device.

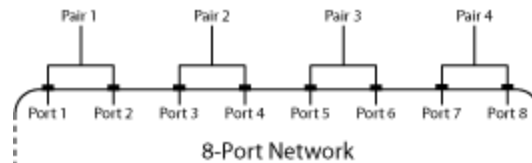

- 3 — s2sdd pairs the input ports in ascending order and the output ports in descending order. For example, in a single-ended, 8-port network:
  - Ports 1 and 2 become differential-mode pair 1.
  - Ports 3 and 4 become differential-mode pair 2.
  - Ports 8 and 7 become differential-mode pair 3.
  - Ports 6 and 5 become differential-mode pair 4.

The following figure illustrates this convention for an 8-port device.

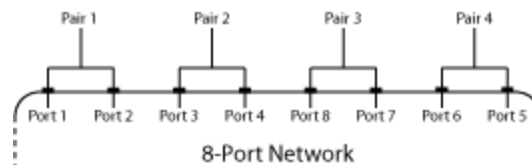

## Examples

Convert network data to differential-mode S-parameters using the default port ordering:

```

ckt = read(rfckt.passive, 'default.s4p');
s4p = ckt.NetworkData.Data;
s_dd = s2sdd(s4p);

```

Read a data file, transform the data into differential-mode S-parameters, analyze the new data, and write the new data to a file:

```

% Create a circuit object from a data file
ckt = read(rfckt.passive, 'default.s4p');
data = ckt.AnalyzedResult;
% Create a data object to store the
% differential S-parameters
diffSparams = rfdata.network;
diffSparams.Freq = data.Freq;
diffSparams.Data = s2sdd(data.S_Parameters);
diffSparams.Z0 = 2*data.Z0;
% Create a new circuit object with the data
% from the data object
diffCkt = rfckt.passive;
diffCkt.NetworkData = diffSparams;
% Analyze the new circuit object
frequencyRange = diffCkt.NetworkData.Freq;
ZL = 50;
ZS = 50;
Z0 = diffSparams.Z0;
analyze(diffCkt, frequencyRange, ZL, ZS, Z0);
diffData = diffCkt.AnalyzedResult;
% Write the differential S-parameters into a

```

```
% Touchstone data file  
write(DiffCkt, 'diffsparams.s2p');
```

## References

Fan, W., A. C. W. Lu, L. L. Wai, and B. K. Lok. “Mixed-Mode S-Parameter Characterization of Differential Structures.” *Electronic Packaging Technology Conference*, pp. 533–537, 2003.

## See Also

s2scc | s2scd | s2sdc | s2smm | smm2s



**Purpose** Convert single-ended S-parameters to mixed-mode S-parameters

**Syntax**

```
[s_dd,s_dc,s_cd,s_cc] = s2simm(s_params_even)
s_mm = s2simm(s_params_odd,option)
```

**Description**

`[s_dd,s_dc,s_cd,s_cc] = s2simm(s_params_even)` converts the  $2N$ -port, single-ended S-parameters `s_params_even` into  $N$ -port, mixed-mode S-parameters. `s2simm` forms the mixed-mode ports by grouping the single-ended ports in pairs by port number (index), grouping odd-numbered ports first, followed by even-numbered ports.

`s_mm = s2simm(s_params_odd,option)` converts the S-parameter data according the port-numbering convention specified by `option`. You can also reorder the ports in `s_params` using the `snp2smp` function.

## Input Arguments

### **s\_params\_even**

`s_params_even` is a complex  $2N$ -by- $2N$ -by- $K$  array representing  $K$  single-ended,  $2N$ -port S-parameters. These parameters describe a device with an even number of ports.

### **option**

1 (default) | 2 | 3

`option` determines how the function orders the ports:

- 1 — `s2simm` pairs the odd-numbered ports together first, followed by the even-numbered ports. For example, in a single-ended, 8-port network:
  - Ports 1 and 3 become mixed-mode pair 1.
  - Ports 5 and 7 become mixed-mode pair 2.
  - Ports 2 and 4 become mixed-mode pair 3.
  - Ports 6 and 8 become mixed-mode pair 4.

The following figure illustrates this convention for an 8-port device.

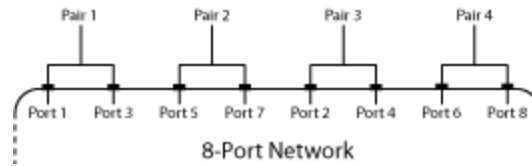

- 2 — s2smm pairs the input and output ports in ascending order. For example, in a single-ended, 8-port network:
  - Ports 1 and 2 become mixed-mode pair 1.
  - Ports 3 and 4 become mixed-mode pair 2.
  - Ports 5 and 6 become mixed-mode pair 3.
  - Ports 7 and 8 become mixed-mode pair 4.

The following figure illustrates this convention for an 8-port device.

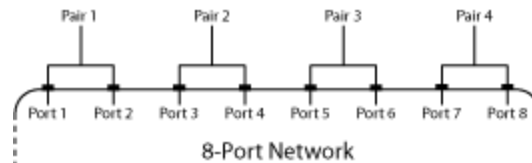

- 3 — s2smm pairs the input ports in ascending order and the output ports in descending order. For example, in a single-ended, 8-port network:
  - Ports 1 and 2 become mixed-mode pair 1.
  - Ports 3 and 4 become mixed-mode pair 2.
  - Ports 8 and 7 become mixed-mode pair 3.
  - Ports 6 and 5 become mixed-mode pair 4.

The following figure illustrates this convention for an 8-port device.

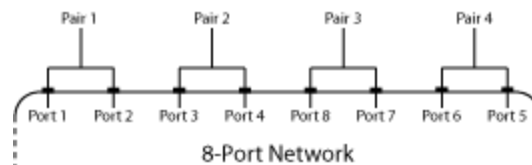

### **s\_params\_odd**

`s_params_odd` is a complex  $(2N + 1)$ -by- $(2N + 1)$ -by- $K$  array representing  $K$  single-ended,  $(2N)$ -port S-parameters. These parameters describe a device with an odd number of ports.

The port-ordering argument `option` is not available for  $(2N + 1)$ -by- $(2N + 1)$ -by- $K$  input arrays. In this case, the ports are always paired in ascending order, and the last port remains single-ended. For example, in a 7-port network:

- Ports 1 and 2 become mixed-mode pair 1.
- Ports 3 and 4 become mixed-mode pair 2.
- Ports 5 and 6 become mixed-mode pair 3.
- Ports 7 remains single ended.

The following figure illustrates this convention for a 7-port device.

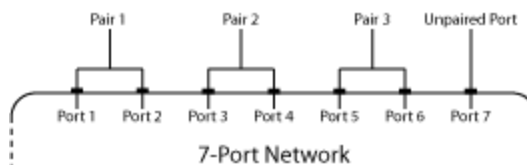

## **Output Arguments**

### **s\_dd**

`s_dd` is a complex  $N$ -by- $N$ -by- $K$  array containing  $K$  matrices of differential-mode,  $2N$ -port S-parameters ( $S_{dd}$ ).

### **s\_dc**

`s_dc` is a complex  $N$ -by- $N$ -by- $K$  array containing  $K$  matrices of cross-mode,  $N$ -port S-parameters ( $S_{dc}$ ).

## **s\_cd**

`s_cd` is a complex  $N$ -by- $N$ -by- $K$  array containing  $K$  matrices of cross-mode,  $N$ -port S-parameters ( $S_{cd}$ ).

## **s\_cc**

`s_cc` is a complex  $N$ -by- $N$ -by- $K$  array containing  $K$  matrices of common-mode,  $N$ -port S-parameters ( $S_{cc}$ ).

## **s\_mm**

`s_mm` is a complex  $(2N + 1)$ -by- $(2N + 1)$ -by- $K$  array containing  $K$  matrices of mixed-mode S-parameters. The parameters are organized in the matrix as follows:

$$\begin{bmatrix} S_{dd,11} & \cdots & S_{dd,1N} & S_{dc,11} & \cdots & S_{dc,1N} & S_{ds,1} \\ \vdots & \ddots & \vdots & \vdots & \ddots & \vdots & \vdots \\ S_{dd,N1} & \cdots & S_{dd,NN} & S_{dc,N1} & \cdots & S_{dc,NN} & S_{ds,N} \\ S_{cd,11} & \cdots & S_{cd,1N} & S_{cc,11} & \cdots & S_{cc,1N} & S_{cs,1} \\ \vdots & \ddots & \vdots & \vdots & \ddots & \vdots & \vdots \\ S_{cd,N1} & \cdots & S_{cd,NN} & S_{cc,N1} & \cdots & S_{cc,NN} & S_{cs,N} \\ S_{sd,1} & \cdots & S_{sd,N} & S_{sc,1} & \cdots & S_{sc,N} & S_{ss} \end{bmatrix}$$

## **Examples**

Convert 4-port S-parameters to 2-port, mixed-mode S-parameters:

```
ckt = read(rfckt.passive,'default.s4p');
s4p = ckt.NetworkData.Data;
[s_dd,s_dc,s_cd,s_cc] = s2simm(s4p);
```

## **References**

Granberg, T., *Handbook of Digital Techniques for High-Speed Design*. Upper Saddle River, NJ: Prentice Hall, 2004.

## **See Also**

s2scc | s2scd | s2sdc | s2sdd | smm2s | snp2smp

**Purpose** Convert S-parameters to T-parameters

**Syntax** `t_params = s2t(s_params)`

**Description** `t_params = s2t(s_params)` converts the scattering parameters `s_params` into the chain scattering parameters `t_params`. The `s_params` input is a complex 2-by-2-by- $M$  array, representing  $M$  2-port S-parameters. `t_params` is a complex 2-by-2-by- $M$  array, representing  $M$  2-port T-parameters.

This function uses the following definition for T-parameters:

$$\begin{bmatrix} a_1 \\ b_1 \end{bmatrix} = \begin{bmatrix} T_{11} & T_{12} \\ T_{21} & T_{22} \end{bmatrix} \begin{bmatrix} b_2 \\ a_2 \end{bmatrix},$$

where:

- $a_1$  is the incident wave at the first port.
- $b_1$  is the reflected wave at the first port.
- $a_2$  is the incident wave at the second port.
- $b_2$  is the reflected wave at the second port.

**Examples** Convert S-parameters to T-parameters:

```
%Define a matrix of S-parameters
s11 = 0.61*exp(j*165/180*pi);
s21 = 3.72*exp(j*59/180*pi);
s12 = 0.05*exp(j*42/180*pi);
s22 = 0.45*exp(j*(-48/180)*pi);
s_params = [s11 s12; s21 s22];
%Convert to T-parameters
t_params = s2t(s_params)
```

**References** Gonzalez, Guillermo, *Microwave Transistor Amplifiers: Analysis and Design*, 2nd edition. Prentice-Hall, 1997, p. 25.

**See Also**

s2abcd | s2h | s2y | s2z | t2s

**Purpose** Convert S-parameters of 2-port network to voltage or power-wave transfer function

**Syntax**

```
tf = s2tf(s_params)
tf = s2tf(s_params, z0, zs, z1)
tf = s2tf(s_params, z0, zs, z1, option)

tf = s2tf(hs)
tf = s2tf(hs, zs, z1)
tf = s2tf(hs, zs, z1, option)
```

**Description** `tf = s2tf(s_params)` converts the scattering parameters, `s_params`, of a 2-port network into the voltage transfer function of the network.

`tf = s2tf(s_params, z0, zs, z1)` calculates the voltage transfer function using the reference impedance `z0`, source impedance `zs`, and load impedance `z1`.

`tf = s2tf(s_params, z0, zs, z1, option)` calculates the voltage or power-wave transfer function using the method specified by `option`.

`tf = s2tf(hs)` converts the 2-port S-parameter object, `hs`, into the voltage transfer function of the network.

`tf = s2tf(hs, zs, z1)` calculates the voltage transfer function using the source impedance `zs`, and load impedance `z1`.

`tf = s2tf(hs, zs, z1, option)` calculates the voltage or power-wave transfer function using the method specified by `option`.

**Algorithms** The following figure shows the setup for computing the transfer function, along with the impedances, voltages, and the power waves used to determine the gain.



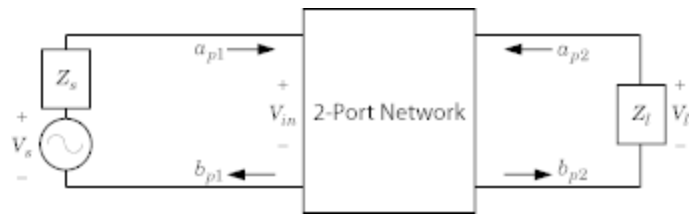

The function uses the following voltages and power waves for calculations:

- $V_l$  is the output voltage across the load impedance.
- $V_s$  is the source voltage.
- $V_{in}$  is the input voltage of the 2-port network.

- $a_{p1}$  is the incident power wave, equal to  $\frac{V_s}{2\sqrt{\text{Re}(Z_s)}}$ .

- $b_{p2}$  is the transmitted power wave, equal to  $\frac{\sqrt{\text{Re}(Z_l)}}{Z_l} V_l$ .

## Input Arguments

### hs

2-port S-parameters, specified as an RF Toolbox S-parameter object.

### s\_params

s\_params is a complex 2-by-2-by- $M$  array that represents  $M$  2-port S-parameters.

### z0

z0 is the reference impedance, in ohms, of the S-parameters.

**Default:** 50

### zs

zs is the source impedance, in ohms, of the S-parameters.

**Default:** 50

**zl**

zl is the load impedance, in ohms, of the S-parameters.

**Default:** 50

**option**

The optional option argument is an integer equal to 1, 2, or 3. The value of option specifies the transfer function type:

- 1 — The transfer function is the gain from the incident voltage,  $V_a$ , to the output voltage for arbitrary source and load impedances:

$$tf = \frac{V_l}{V_a}$$

The following figure shows how to compute  $V_a$  from the source voltage  $V_s$ :

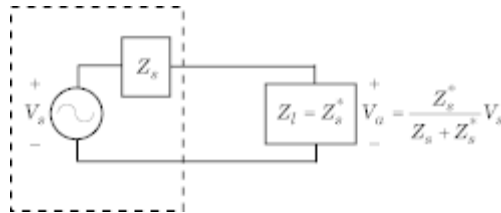

For the S-parameters and impedance values, the transfer function is:

$$tf = \frac{(Z_s + Z_s^*)}{Z_s^*} \frac{S_{21}(1 + \Gamma_l)(1 - \Gamma_s)}{2(1 - S_{22}\Gamma_l)(1 - \Gamma_{in}\Gamma_s)}$$

where:

$$\Gamma_l = \frac{Z_l - Z_o}{Z_l + Z_o}$$

$$\Gamma_s = \frac{Z_s - Z_o}{Z_s + Z_o}$$

$$\Gamma_{in} = S_{11} + \left( S_{12} S_{21} \frac{\Gamma_l}{(1 - S_{22} \Gamma_l)} \right)$$

The following equation shows how the preceding transfer function is related to the transducer gain computed by the powergain function:

$$G_T = |tf|^2 \frac{\operatorname{Re}(Z_l)}{|Z_l|^2} \frac{|Z_s|^2}{\operatorname{Re}(Z_s)}$$

Notice that if  $Z_l$  and  $Z_s$  are real,  $G_T = |tf|^2 \frac{Z_s}{Z_l}$ .

- 2 — The transfer function is the gain from the source voltage to the output voltage for arbitrary source and load impedances:

$$tf = \frac{V_l}{V_s} = \frac{S_{21}(1 + \Gamma_l)(1 - \Gamma_s)}{2(1 - S_{22}\Gamma_l)(1 - \Gamma_{in}\Gamma_s)}$$

You can use this option to compute the transfer function  $\frac{V_L}{V_s^{in}}$  by setting `zs` to 0. This setting means that  $\Gamma_s = -1$  and  $V_{in} = V_s^{in}$ .

- 3 — The transfer function is the power-wave gain from the incident power wave at the first port to the transmitted power wave at the second port:

$$tf = \frac{b_{p2}}{a_{p1}} = \frac{\sqrt{\operatorname{Re}(Z_l)\operatorname{Re}(Z_s)}}{Z_l} \frac{S_{21}(1 + \Gamma_l)(1 - \Gamma_s)}{(1 - S_{22}\Gamma_l)(1 - \Gamma_{in}\Gamma_s)}$$

**Default:** 1

# s2tf

---

## Output Arguments

**tf**

## Examples

Calculate the voltage transfer function of an S-parameter array:

```
ckt = read(rfckt.passive, 'passive.s2p');  
sparams = ckt.NetworkData.Data;  
tf = s2tf(sparams)
```

## See Also

[powergain](#) | [rationalfit](#) | [s2scc](#) | [s2scd](#) | [s2sdc](#) | [s2sdd](#) | [snp2smp](#)

---

<b>Purpose</b>	Convert S-parameters to Y-parameters
<b>Syntax</b>	<code>y_params = s2y(s_params,z0)</code>
<b>Description</b>	<code>y_params = s2y(s_params,z0)</code> converts the scattering parameters <code>s_params</code> into the admittance parameters <code>y_params</code> . The <code>s_params</code> input is a complex $N$ -by- $N$ -by- $M$ array, representing $M$ $N$ -port S-parameters. <code>z0</code> is the reference impedance; its default is 50 ohms. <code>y_params</code> is a complex $N$ -by- $N$ -by- $M$ array, representing $M$ $N$ -port Y-parameters.
<b>Alternatives</b>	You can also use network parameter objects to perform network parameter conversions. For more information, see “RF Network Parameter Objects” on page 2-12.
<b>Examples</b>	Convert S-parameters to Y-parameters:  <pre>%Define a matrix of S-parameters s_11 = 0.61*exp(j*165/180*pi); s_21 = 3.72*exp(j*59/180*pi); s_12 = 0.05*exp(j*42/180*pi); s_22 = 0.45*exp(j*(-48/180)*pi); s_params = [s_11 s_12; s_21 s_22]; z0 = 50; %Convert to Y-parameters y_params = s2y(s_params,z0)</pre>
<b>See Also</b>	<code>abcd2y</code>   <code>h2y</code>   <code>s2abcd</code>   <code>s2h</code>   <code>s2z</code>   <code>y2s</code>   <code>z2y</code>

**Purpose** Convert S-parameters to Z-parameters

**Syntax** `z_params = s2z(s_params,z0)`

**Description** `z_params = s2z(s_params,z0)` converts the scattering parameters `s_params` into the impedance parameters `z_params`. The `s_params` input is a complex  $N$ -by- $N$ -by- $M$  array, representing  $M$   $N$ -port S-parameters. `z0` is the reference impedance; its default is 50 ohms. `z_params` is a complex  $N$ -by- $N$ -by- $M$  array, representing  $M$   $N$ -port Z-parameters.

**Alternatives** You can also use network parameter objects to perform network parameter conversions. For more information, see “RF Network Parameter Objects” on page 2-12.

**Examples** Convert S-parameters to Z-parameters:

```
%Define a matrix of S-parameters
s_11 = 0.61*exp(j*165/180*pi);
s_21 = 3.72*exp(j*59/180*pi);
s_12 = 0.05*exp(j*42/180*pi);
s_22 = 0.45*exp(j*(-48/180)*pi);
s_params = [s_11 s_12; s_21 s_22];
z0 = 50;
%Convert to Z-parameters
z_params = s2z(s_params,z0)
```

**See Also** `abcd2z` | `h2z` | `s2abcd` | `s2h` | `s2y` | `y2z` | `z2s`

**Purpose** Plot complex vector on Smith chart

**Syntax** `[lineseries,hsm] = smithchart(y)`  
`hsm = smithchart`

**Description** `[lineseries,hsm] = smithchart(y)` plots the complex vector `y` on a Smith chart. `hsm` is the handle of the Smith chart object. `lineseries` is a column vector of handles to `lineseries` objects, one handle per plotted line.

To plot network parameters from a circuit (`rfckt`) or data (`rfddata`) object on a Smith chart, use the `smith` function.

`hsm = smithchart` draws a blank Smith chart and returns the handle, `hsm`, of the Smith chart object.

## Output Arguments

### `lineseries`

You change the properties of the plotted lines by changing the `lineseries` properties.

### `hsm`

`hsm = smithchart` creates the plot using default property values of a Smith chart. Use `set(h, 'PropertyName1', PropertyValue1, ...)` to change the property values. Use `get(h)` to get the property values.

This table lists all properties you can specify for `smithchart` objects along with units, valid values, and descriptions of their use.

Property Name	Description	Units and Values
Color	Line color for a Z or Y Smith chart. For a ZY Smith chart, the Z line color.	ColorSpec. Default is [0.4 0.4 0.4] (dark gray).
LabelColor	Color of the line labels.	ColorSpec. Default is [0 0 0] (black).

# smithchart

---

<b>Property Name</b>	<b>Description</b>	<b>Units and Values</b>
LabelSize	Size of the line labels.	FontSize. Default is 10. See the Annotation Textbox Properties reference page for more information on specifying font size.
LabelVisible	Visibility of the line labels.	'on' (default) or 'off'
LineType	Line spec for a Z or Y Smith chart. For a ZY Smith chart, the Z line spec.	LineSpec. Default is '-' (solid line).
LineWidth	Line width for a Z or Y Smith chart. For a ZY Smith chart, the Z line width.	Number of points. Default is 0.5.
SubColor	The Y line color for a ZY Smith chart.	ColorSpec. Default is [0.8 0.8 0.8] (medium gray).
SubLineType	The Y line spec for a ZY Smith chart.	LineSpec. Default is ':' (dotted line).
SubLineWidth	The Y line width for a ZY Smith chart.	Number of points. Default is 0.5.



Property Name	Description	Units and Values
Type	Type of Smith chart.	'z' (default), 'y', or 'zy'
Value	Two-row matrix. Row 1 specifies the values of the constant resistance and reactance lines in the chart. For the constant resistance and reactance lines, each element in Row 2 specifies the value at which the corresponding line in Row 1 ends.	2-by-n matrix. Default is [0.2000 0.5000 1.0000 2.0000 5.0000; 1.0000 2.0000 5.0000 5.0000 30.0000]

## Examples

### Plot data on a Smith Chart

Define a vector of complex data.

```
smithdata = 0.1+j*[1:1000]*0.001;
smithchart(smithdata);
```

# smithchart

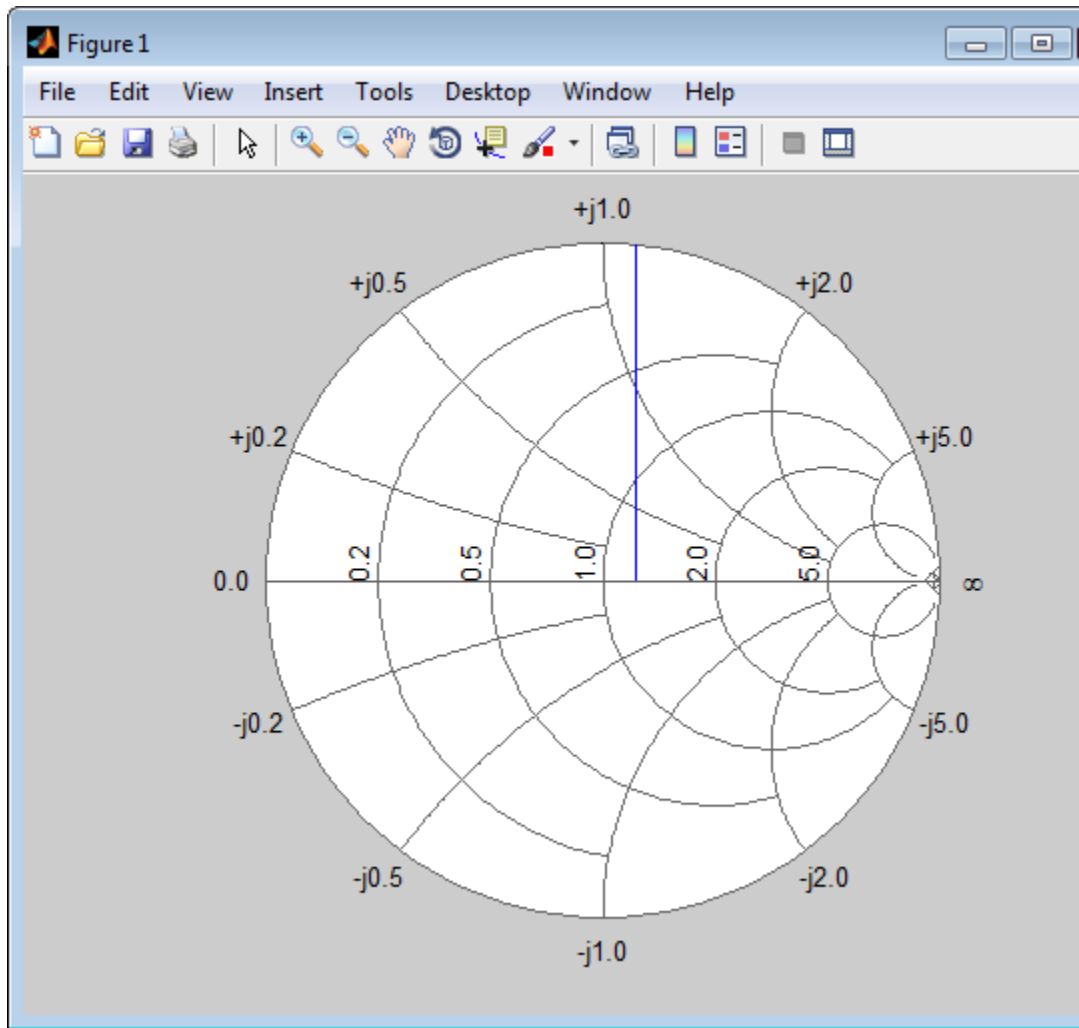

Using this vector as input to smithchart does not produce the expected result because the Smith Chart is drawn on the normal Cartesian coordinate system. However, you can use the `z2gamma` function to

perform a bilinear transform on the vector first, converting the data to the Smith Chart coordinate system.

```
smithdata_trans = z2gamma(smithdata,1);  
smithchart(smithdata_trans);
```

# smithchart

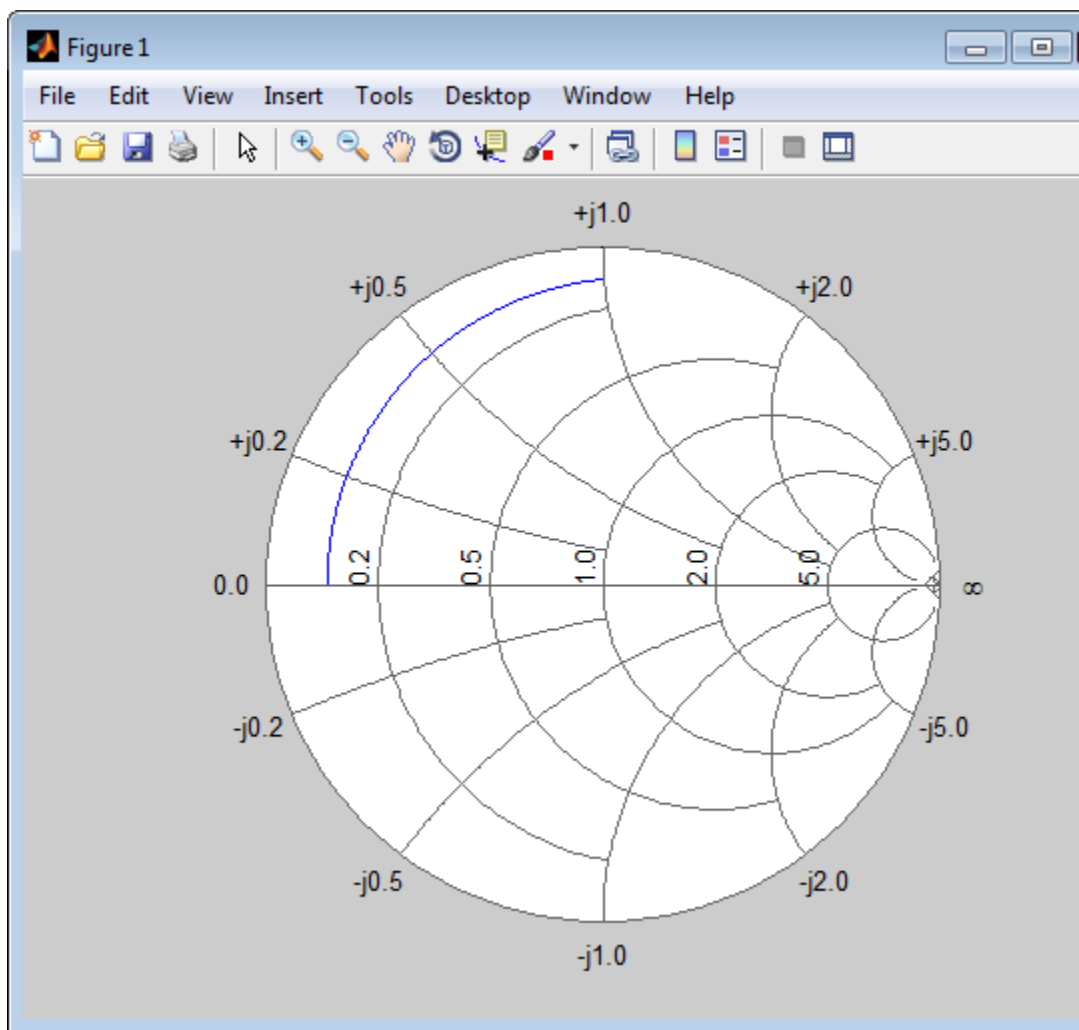

## See Also

`get` | `set` | `smith`

**Purpose** Convert mixed-mode 2N-port S-parameters to single-ended 4N-port S-parameters

**Syntax**  
`s_params = smm2s(s_dd,s_dc,s_cd,s_cc)`  
`s_params = smm2s(s_dd,s_dc,s_cd,s_cc,option)`

**Description** `s_params = smm2s(s_dd,s_dc,s_cd,s_cc)` converts mixed-mode,  $N$ -port S-parameters into single-ended,  $2N$ -port S-parameters, `s_params`. `smm2s` maps the first half of the mixed-mode ports to the odd-numbered pairs of single-ended ports and maps the second half to the even-numbered pairs.

`s_params = smm2s(s_dd,s_dc,s_cd,s_cc,option)` converts the S-parameter data using the optional argument `option`. You can also reorder the ports in `s_params` using the `snp2smp` function.

**Input Arguments**

**s\_cc**  
`s_cc` is a complex  $N$ -by- $N$ -by- $K$  array containing  $K$  matrices of common-mode,  $N$ -port S-parameters ( $S_{cc}$ ).

**s\_cd**  
`s_cd` is a complex  $N$ -by- $N$ -by- $K$  array containing  $K$  matrices of cross-mode,  $N$ -port S-parameters ( $S_{cd}$ ).

**s\_dc**  
`s_dc` is a complex  $N$ -by- $N$ -by- $K$  array containing  $K$  matrices of cross-mode,  $N$ -port S-parameters ( $S_{dc}$ ).

**s\_dd**  
`s_dd` is a complex  $N$ -by- $N$ -by- $K$  array containing  $K$  matrices of differential-mode,  $N$ -port S-parameters ( $S_{dd}$ ).

**option**  
 1 (default) | 2 | 3

option determines how the function orders the ports:

- 1 — smm2s maps the first half of the mixed-mode pairs to odd-numbered pairs of single-ended ports and maps the second half to even-numbered pairs. For example, in a mixed-mode, 4-port network:
  - Port 1 becomes single-ended ports 1 and 3.
  - Port 2 becomes single-ended ports 5 and 7.
  - Port 3 becomes single-ended ports 2 and 4.
  - Port 4 becomes single-ended ports 6 and 8.

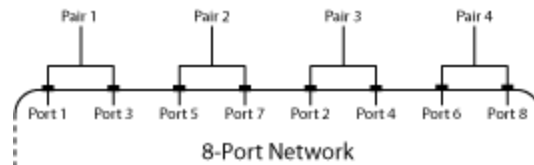

- 2 — smm2s maps the first half of the mixed-mode pairs to single-ended ports in ascending numerical order, followed by the second half, also in ascending order. For example, in a mixed-mode, 4-port network:
  - Port 1 becomes single-ended ports 1 and 2.
  - Port 2 becomes single-ended ports 3 and 4.
  - Port 3 becomes single-ended ports 5 and 6.
  - Port 4 becomes single-ended ports 7 and 8.

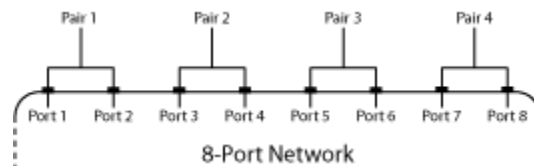

- 3 — smm2s maps the first half of the mixed-mode pairs to single-ended ports in ascending numerical order. The function maps the second half to pairs of ports in descending order. For example, in a mixed-mode, 4-port network:

- Port 1 becomes single-ended ports 1 and 2.
- Port 2 becomes single-ended ports 3 and 4.
- Port 3 becomes single-ended ports 8 and 7.
- Port 4 becomes single-ended ports 6 and 5.

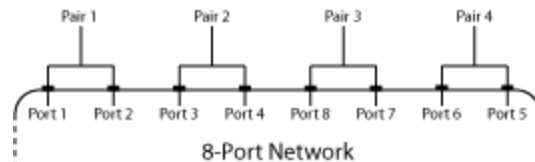

## Output Arguments

### s\_params

s\_params is a complex  $2N$ -by- $2N$ -by- $K$  array representing  $K$  single-ended,  $2N$ -port S-parameters.

## Examples

Convert between mixed-mode and single-ended S-parameters:

```
% Create mixed-mode S-parameters:
ckt = read(rfckt.passive,'default.s4p');
s4p = ckt.NetworkData.Data;
[sdd,scd,sdc,scs] = s2simm(s4p);
% Convert them back to 4-port, single-ended S-parameters:
s4p_converted_back = simm2s(sdd,scd,sdc,scs);
```

## References

Granberg, T., *Handbook of Digital Techniques for High-Speed Design*. Upper Saddle River, NJ: Prentice Hall, 2004.

## See Also

s2scs | s2scd | s2sdc | s2sdd | s2simm | snp2smp

# snp2smp

**Purpose** Convert single-ended N-port S-parameters to single-ended M-port S-parameters

**Syntax**  
`s_params_mp = snp2smp(s_params_np)`  
`s_params_mp = snp2smp(s_params_np,Z0,n2m_index,ZT)`

**Description** `s_params_mp = snp2smp(s_params_np)` converts the single-ended N-port S-parameters, `s_params_np`, into the single-ended M-port S-parameters, `s_params_mp`. *M* must be less than or equal to *N*.

`s_params_mp = snp2smp(s_params_np,Z0,n2m_index,ZT)` converts the S-parameter data using the optional arguments *Z0*, *n2m\_index*, and *ZT* that control the conversion.

The following figure illustrates how to use the optional input arguments to specify the ports for the output data and the termination of the remaining ports.

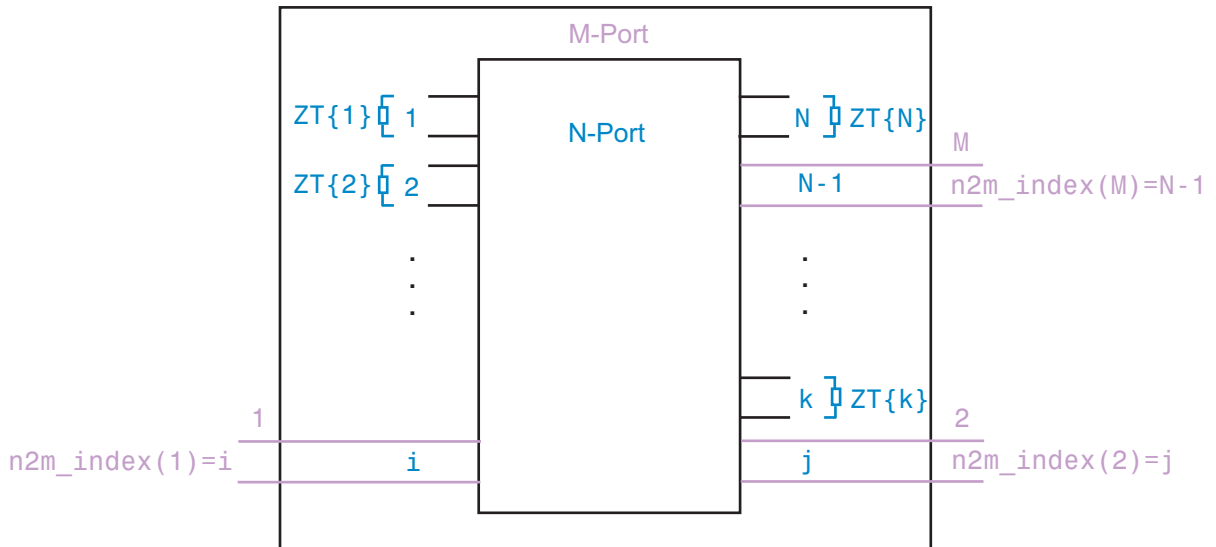



## Input Arguments

### **s\_params\_np**

s\_params\_np is a complex  $N$ -by- $N$ -by- $K$  array representing  $K$   $N$ -port S-parameters.

### **Z0**

Z0 is the reference impedance, in ohms, of s\_params\_np and s\_params\_mp.

**Default:** 50

### **n2m\_index**

n2m\_index is a vector of length  $M$  specifying how the ports of the  $N$ -port S-parameters map to the ports of the  $M$ -port S-parameters. n2m\_index( $i$ ) is the index of the port from s\_params\_np that the function converts to the  $i$ th port of s\_params\_mp. For example, the setting [1, 2] means that  $M$  is 2, and the first two ports of the  $N$ -port S-parameters become the ports of the  $M$ -port parameters. The function terminates any additional ports with the impedances specified by ZT.

**Default:** [1, 2]

### **ZT**

ZT is a scalar, vector, or cell array specifying the termination impedance of the ports. If  $M$  is less than  $N$ , snp2smp terminates the  $N-M$  ports not listed in n2m\_index using the values in ZT. If ZT is a scalar, the function terminates all  $N-M$  ports not listed in n2m\_index by the same impedance ZT. If ZT is a vector of length  $K$ , ZT[ $i$ ] is the impedance that terminates all  $N-M$  ports of the  $i$ th frequency point not listed in n2m\_index. If ZT is a cell array of length  $N$ , ZT{ $j$ } is the impedance that terminates the  $j$ th port of the  $N$ -port S-parameters. The function ignores impedances related to the ports listed in n2m\_index. Each ZT{ $j$ } can be a scalar or a vector of length  $K$ .

The following figure illustrates how to use the optional input arguments to specify the ports for the output data and the termination of the remaining ports.

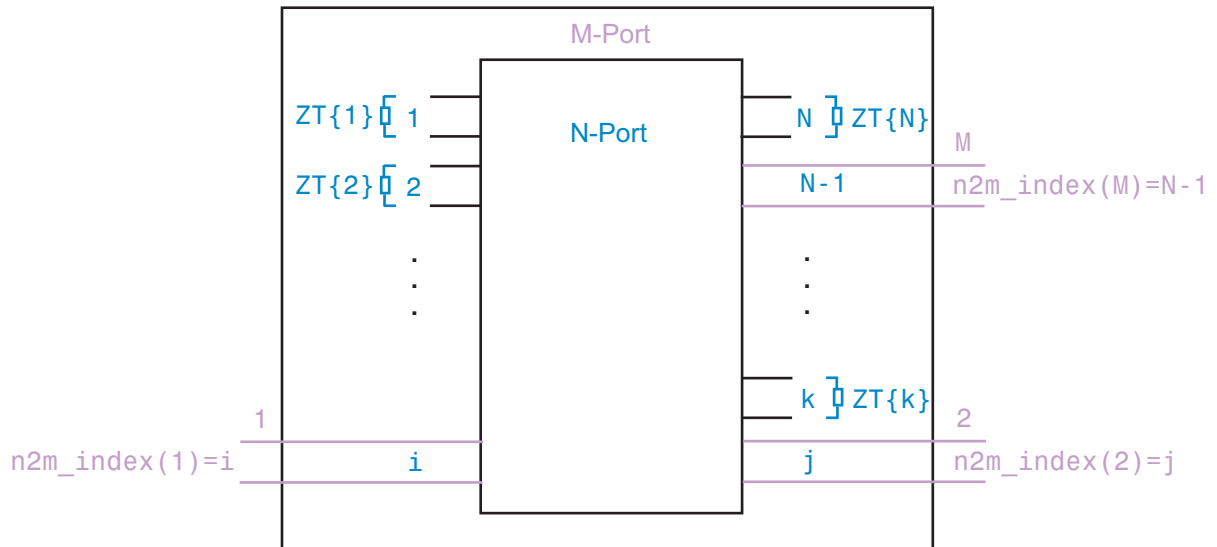

**Default:**  $Z_0$

## Examples

Convert 3-port S-parameters to 3-port S-parameters with port indices swapped from  $[1\ 2\ 3]$  to  $[2\ 3\ 1]$ :

```

ckt = read(rfckt.passive,'default.s3p');
%default.s3p represents a real counterclockwise circulator
s3p = ckt.NetworkData.Data;
Z0 = ckt.NetworkData.Z0;
s3p_new = snp2smp(s3p,Z0,[2 3 1])

```

Convert 3-port S-parameters to 2-port S-parameters by terminating port 3 with an impedance of  $Z_0$ :

```

ckt = read(rfckt.passive,'default.s3p');

```

```
s3p = ckt.NetworkData.Data;  
Z0 = ckt.NetworkData.Z0;  
s2p = snp2smp(s3p,Z0);
```

Convert 16-port S-parameters to 4-port S-parameters by using ports 1, 16, 2, and 15 as the first, second, third, and fourth ports; terminate the remaining 12 ports with an impedance of Z0:

```
ckt = read(rfckt.passive,'default.s16p');  
s16p = ckt.NetworkData.Data;  
Z0 = ckt.NetworkData.Z0;  
s4p = snp2smp(s16p,Z0,[1 16 2 15],Z0)
```

Convert 16-port S-parameters to 4-port S-parameters by using ports 1, 16, 2, and 15 as the first, second, third, and fourth ports; terminate port 4 with an impedance of 100 ohms and terminate the remaining 11 ports with an impedance of 50 ohms:

```
ckt = read(rfckt.passive,'default.s16p');  
s16p = ckt.NetworkData.Data;  
Z0 = ckt.NetworkData.Z0;  
ZT = {};  
ZT(1:16) = {50};  
ZT{4} = 100;  
s4p = snp2smp(s16p,Z0,[1 16 2 15],ZT)
```

## See Also

freqresp | rfmodel.rational | s2tf | timeresp | writeva

# stabilityk

---

**Purpose** Stability factor  $K$  of 2-port network

**Syntax** `[k,b1,b2,delta] = stabilityk(s_params)`  
`[k,b1,b2,delta] = stabilityk(hs)`

**Description** `[k,b1,b2,delta] = stabilityk(s_params)` calculates and returns the stability factor,  $k$ , and the conditions  $b1$ ,  $b2$ , and  $delta$  for the 2-port network. The input `s_params` is a complex 2-by-2-by- $M$  array, representing  $M$  2-port S-parameters.

`[k,b1,b2,delta] = stabilityk(hs)` calculates and returns the stability factor and stability conditions for the 2-port network represented by the S-parameter object `hs`.

**Algorithms** Necessary and sufficient conditions for stability are  $k > 1$  and  $abs(delta) < 1$ . `stabilityk` calculates the outputs using the equations

$$K = \frac{1 - |S_{11}|^2 - |S_{22}|^2 + |\Delta|^2}{2|S_{12}S_{21}|}$$

$$B_1 = 1 + |S_{11}|^2 - |S_{22}|^2 - |\Delta|^2$$

$$B_2 = 1 - |S_{11}|^2 + |S_{22}|^2 - |\Delta|^2$$

where:

- $S_{11}$ ,  $S_{12}$ ,  $S_{21}$ , and  $S_{22}$  are S-parameters from the input argument `s_params`.
- $\Delta$  is a vector whose members are the determinants of the  $M$  2-port S-parameter matrices:

$$\Delta = S_{11}S_{22} - S_{12}S_{21}$$

The function performs these calculations element-wise for each of the  $M$  S-parameter matrices in `s_params`.

**Examples**

Examine the stability of network data from a file:

```
% Calculate stability factor and conditions
ckt = read(rfckt.passive,'passive.s2p');
s_params = ckt.NetworkData.Data;
freq = ckt.NetworkData.Freq;
[k b1 b2 delta] = stabilityk(s_params);
% Check stability criteria
stability_index = (k>1)&(abs(delta)<1);
is_stable = all(stability_index)
% List frequencies with unstable S-parameters
freq_unstable = freq(~stability_index);
```

**References**

Gonzalez, Guillermo, *Microwave Transistor Amplifiers: Analysis and Design*, 2nd edition. Prentice-Hall, 1997, pp. 217–228.

**See Also**

gammaml | gammams | stabilitymu

# stabilitymu

---

**Purpose** Stability factor  $\mu$  of 2-port network

**Syntax** `[mu,muprime] = stabilitymu(s_params)`

**Description** `[mu,muprime] = stabilitymu(s_params)` calculates and returns the stability factors  $\mu$  and  $\mu'$  of a 2-port network. The input `s_params` is a complex 2-by-2-by- $M$  array, representing  $M$  2-port S-parameters.

`[mu,muprime] = stabilitymu(hs)` calculates and returns the stability factors for the network represented by the S-parameter object `hs`.

The stability factor,  $\mu$ , defines the minimum distance between the center of the unit Smith chart and the unstable region in the load plane. The function assumes that port 2 is the load.

The stability factor,  $\mu'$ , defines the minimum distance between the center of the unit Smith chart and the unstable region in the source plane. The function assumes that port 1 is the source.

Having  $\mu > 1$  or  $\mu' > 1$  is the necessary and sufficient condition for the 2-port linear network to be unconditionally stable, as described by the S-parameters.

**Algorithms** `stabilitymu` calculates the stability factors using the equations

$$\mu = \frac{1 - |S_{11}|^2}{|S_{22} - S_{11}^* \Delta| + |S_{21} S_{12}|}$$
$$\mu' = \frac{1 - |S_{22}|^2}{|S_{11} - S_{22}^* \Delta| + |S_{21} S_{12}|}$$

where:

- $S_{11}$ ,  $S_{12}$ ,  $S_{21}$ , and  $S_{22}$  are S-parameters, from the input argument `s_params`.
- $\Delta$  is a vector whose members are the determinants of the  $M$  2-port S-parameter matrices:

$$\Delta = S_{11}S_{22} - S_{12}S_{21}$$

- $S^*$  is the complex conjugate of the corresponding S-parameter.

The function performs these calculations element-wise for each of the  $M$  S-parameter matrices in `s_params`.

## Examples

Examine the stability of network data from a file:

```
% Calculate stability factor and conditions
ckt = read(rfckt.passive,'passive.s2p');
s_params = ckt.NetworkData.Data;
freq = ckt.NetworkData.Freq;
[mu muprime] = stabilitymu(s_params);
% Check stability criteria
stability_index = (mu>1)|(muprime>1);
is_stable = all(stability_index)
% List frequencies with unstable S-parameters
freq_unstable = freq(~stability_index);
```

## References

Edwards, Marion Lee, and Jeffrey H. Sinsky, "A New Criterion for Linear 2-Port Stability Using a Single Geometrically Derived Parameter," *IEEE Transactions on Microwave Theory and Techniques*, Vol. 40, No. 12, pp. 2303-2311, December 1992.

## See Also

`stabilityk`

**Purpose** Convert T-parameters to S-parameters

**Syntax** `s_params = t2s(t_params)`

**Description** `s_params = t2s(t_params)` converts the chain scattering parameters `t_params` into the scattering parameters `s_params`. The `t_params` input is a complex 2-by-2-by- $M$  array, representing  $M$  2-port T-parameters. `s_params` is a complex 2-by-2-by- $M$  array, representing  $M$  2-port S-parameters.

This function defines the T-parameters as

$$\begin{bmatrix} a_1 \\ b_1 \end{bmatrix} = \begin{bmatrix} T_{11} & T_{12} \\ T_{21} & T_{22} \end{bmatrix} \begin{bmatrix} b_2 \\ a_2 \end{bmatrix},$$

where:

- $a_1$  is the incident wave at the first port.
- $b_1$  is the reflected wave at the first port.
- $a_2$  is the incident wave at the second port.
- $b_2$  is the reflected wave at the second port.

**Examples** Convert T-parameters to S-parameters:

```
%Define a matrix of T-parameters
t11 = 0.138451095405929 - 0.230421317393041i;
t21 = -0.0451985986689165 + 0.157626245839348i;
t12 = 0.0353675449261375 + 0.115682026931012i;
t22 = -0.00194567217559662 - 0.0291212122613417i;
t_params = [t11 t12; t21 t22];
%Convert to S-parameters
s_params = t2s(s_params)
```

**References** Gonzalez, Guillermo, *Microwave Transistor Amplifiers: Analysis and Design*, 2nd edition. Prentice-Hall, 1997, p. 25.



**See Also**

[abcd2s](#) | [h2s](#) | [s2t](#) | [y2s](#) | [z2s](#)

# VSWR

---

**Purpose** VSWR at given reflection coefficient  $\Gamma$

**Syntax** `ratio = vswr(gamma)`

**Description** `ratio = vswr(gamma)` calculates the voltage standing-wave ratio *VSWR* at the given reflection coefficient  $\Gamma$  as

$$VSWR = \frac{1 + |\Gamma|}{1 - |\Gamma|}$$

The input `gamma` is a complex vector. The output `ratio` is a real vector of the same length as `gamma`.

**Examples** Calculate the VSWR for a given reflection coefficient:

```
gamma = 1/3;  
ratio = vswr(gamma)
```

**See Also** `gamma2z` | `gammain` | `gammaout`

**Purpose** Convert Y-parameters to ABCD-parameters

**Syntax** `abcd_params = y2abcd(y_params)`

**Description** `abcd_params = y2abcd(y_params)` converts the admittance parameters `y_params` into the ABCD-parameters `abcd_params`. The `y_params` input is a complex  $2N$ -by- $2N$ -by- $M$  array, representing  $M$   $2N$ -port Y-parameters. `abcd_params` is a complex  $2N$ -by- $2N$ -by- $M$  array, representing  $M$   $2N$ -port ABCD-parameters. The output ABCD-parameter matrices have distinct  $A$ ,  $B$ ,  $C$ , and  $D$  submatrices:

$$\begin{bmatrix} [A] & [B] \\ [C] & [D] \end{bmatrix}$$

**Alternatives** You can also use network parameter objects to perform network parameter conversions. For more information, see “RF Network Parameter Objects” on page 2-12.

**Examples** Convert Y-parameters to ABCD-parameters:

```
%Define a matrix of Y-parameters.
Y11 = 0.0488133074245012 - 0.390764155450191i;
Y12 = -0.0488588365420561 + 0.390719345880018i;
Y21 = -0.0487261119282660 + 0.390851884427087i;
Y22 = 0.0487710062903760 - 0.390800401433241i;
y_params = [Y11,Y12; Y21,Y22];
%Convert to ABCD-parameters
abcd_params = y2abcd(y_params);
```

**See Also** `abcd2y` | `h2abcd` | `s2abcd` | `y2h` | `y2s` | `y2z` | `z2abcd`

**Purpose** Convert Y-parameters to hybrid h-parameters

**Syntax** `h_params = y2h(y_params)`

**Description** `h_params = y2h(y_params)` converts the admittance parameters `y_params` into the hybrid parameters `h_params`. The `y_params` input is a complex 2-by-2-by- $M$  array, representing  $M$  2-port Y-parameters. `h_params` is a complex 2-by-2-by- $M$  array, representing  $M$  2-port hybrid h-parameters.

**Alternatives** You can also use network parameter objects to perform network parameter conversions. For more information, see “RF Network Parameter Objects” on page 2-12.

**Examples** Convert Y-parameters to h-parameters:

```
%Define a matrix of Y-parameters.  
Y11 = 0.0488133074245012 - 0.390764155450191i;  
Y12 = -0.0488588365420561 + 0.390719345880018i;  
Y21 = -0.0487261119282660 + 0.390851884427087i;  
Y22 = 0.0487710062903760 - 0.390800401433241i;  
y_params = [Y11,Y12; Y21,Y22];  
%Convert to h-parameters  
h_params = y2h(y_params);
```

**See Also** `abcd2h` | `h2y` | `s2h` | `y2abcd` | `y2s` | `y2z` | `z2h`

---

<b>Purpose</b>	Convert Y-parameters to S-parameters
<b>Syntax</b>	<code>s_params = y2s(y_params,z0)</code>
<b>Description</b>	<code>s_params = y2s(y_params,z0)</code> converts the admittance parameters <code>y_params</code> into the scattering parameters <code>s_params</code> . The <code>y_params</code> input is a complex $N$ -by- $N$ -by- $M$ array, representing $M$ $N$ -port Y-parameters. <code>z0</code> is the reference impedance. The default value of <code>z0</code> is 50 ohms. <code>s_params</code> is a complex $N$ -by- $N$ -by- $M$ array, representing $M$ $N$ -port S-parameters.
<b>Alternatives</b>	You can also use network parameter objects to perform network parameter conversions. For more information, see “RF Network Parameter Objects” on page 2-12.
<b>Examples</b>	Convert Y-parameters to S-parameters:  <pre>%Define a matrix of Y-parameters. Y11 = 0.0488133074245012 - 0.390764155450191i; Y12 = -0.0488588365420561 + 0.390719345880018i; Y21 = -0.0487261119282660 + 0.390851884427087i; Y22 = 0.0487710062903760 - 0.390800401433241i; y_params = [Y11,Y12; Y21,Y22]; %Convert to S-parameters s_params = y2s(y_params);</pre>
<b>See Also</b>	<code>abcd2s</code>   <code>h2s</code>   <code>s2y</code>   <code>y2abcd</code>   <code>y2h</code>   <code>y2s</code>   <code>y2z</code>   <code>z2s</code>

**Purpose** Convert Y-parameters to Z-parameters

**Syntax** `z_params = y2z(y_params)`

**Description** `y2z(y_params)` converts the admittance parameters `y_params` into the impedance parameters `z_params`. The `y_params` input is a complex N-by-N-by-*M* array, representing *M* N-port Y-parameters. `z_params` is a complex N-by-N-by-*M* array, representing *M* N-port Z-parameters.

**Alternatives** You can also use network parameter objects to perform network parameter conversions. For more information, see “RF Network Parameter Objects” on page 2-12.

**Examples** Convert Y-parameters to Z-parameters:

```
%Define a matrix of Y-parameters.  
Y11 = 0.0488133074245012 - 0.390764155450191i;  
Y12 = -0.0488588365420561 + 0.390719345880018i;  
Y21 = -0.0487261119282660 + 0.390851884427087i;  
Y22 = 0.0487710062903760 - 0.390800401433241i;  
y_params = [Y11,Y12; Y21,Y22];  
%Convert to Z-parameters  
z_params = y2z(y_params);
```

**See Also** `abcd2z` | `h2z` | `y2abcd` | `y2h` | `y2s` | `y2z` | `z2s` | `z2y`

**Purpose** Convert Z-parameters to ABCD-parameters

**Syntax** `abcd_params = z2abcd(z_params)`

**Description** `abcd_params = z2abcd(z_params)` converts the impedance parameters `z_params` into the ABCD-parameters `abcd_params`. The `z_params` input is a complex  $2N$ -by- $2N$ -by- $M$  array, representing  $M$   $2N$ -port Z-parameters. `abcd_params` is a complex  $2N$ -by- $2N$ -by- $M$  array, representing  $M$   $2N$ -port ABCD-parameters. The output ABCD-parameter matrices have distinct  $A$ ,  $B$ ,  $C$ , and  $D$  submatrices:

$$\begin{bmatrix} [A] & [B] \\ [C] & [D] \end{bmatrix}$$

**Alternatives** You can also use network parameter objects to perform network parameter conversions. For more information, see “RF Network Parameter Objects” on page 2-12.

**Examples** Convert Z-parameters to ABCD-parameters:

```
%Define a matrix of Z-parameters.
Z11 = -14567.2412789287 - 148373.315116592i
Z12 = -14588.1106171651 - 148388.583516562i
Z21 = -14528.0522132692 - 148350.705757767i
Z22 = -14548.5996561832 - 148363.457002006i
z_params = [Z11,Z12; Z21,Z22];
%Convert to ABCD-parameters
abcd_params = z2abcd(z_params);
```

**See Also** `abcd2z` | `h2abcd` | `s2abcd` | `y2abcd` | `z2h` | `z2s` | `z2y`

# z2gamma

---

**Purpose** Convert impedance to reflection coefficient

**Syntax**  
gamma = z2gamma(z)  
gamma = z2gamma(z, z0)

**Description**  
gamma = z2gamma(z) converts the impedance z to the reflection coefficient gamma using a reference impedance of 50 ohms.  
gamma = z2gamma(z, z0) converts the impedance z to the reflection coefficient gamma using a reference impedance of z0 ohms.

**Algorithms** z2gamma calculates the coefficient using the equation

$$\Gamma = \frac{Z - Z_0}{Z + Z_0}$$

**Examples** Convert an impedance of 100 ohms into a reflection coefficient, using a 50-ohm reference impedance:

```
z = 100;  
gamma = z2gamma(z)
```

**See Also** gamma2z | gammain | gammaout



---

<b>Purpose</b>	Convert Z-parameters to hybrid h-parameters
<b>Syntax</b>	<code>h_params = z2h(z_params)</code>
<b>Description</b>	<code>h_params = z2h(z_params)</code> converts the impedance parameters <code>z_params</code> into the hybrid parameters <code>h_params</code> . The <code>z_params</code> input is a complex 2-by-2-by- $M$ array, representing $M$ 2-port Z-parameters. <code>h_params</code> is a complex 2-by-2-by- $M$ array, representing $M$ 2-port hybrid h-parameters.
<b>Alternatives</b>	You can also use network parameter objects to perform network parameter conversions. For more information, see “RF Network Parameter Objects” on page 2-12.
<b>Examples</b>	Convert Z-parameters to H-parameters:  <pre>%Define a matrix of Z-parameters. Z11 = -14567.2412789287 - 148373.315116592i Z12 = -14588.1106171651 - 148388.583516562i Z21 = -14528.0522132692 - 148350.705757767i Z22 = -14548.5996561832 - 148363.457002006i z_params = [Z11,Z12; Z21,Z22]; %Convert to h-parameters h_params = z2h(z_params);</pre>
<b>See Also</b>	<code>abcd2h</code>   <code>h2z</code>   <code>s2h</code>   <code>y2h</code>   <code>z2abcd</code>   <code>z2s</code>   <code>z2y</code>

**Purpose** Convert Z-parameters to S-parameters

**Syntax** `s_params = z2s(z_params,z0)`

**Description** `s_params = z2s(z_params,z0)` converts the impedance parameters `z_params` into the scattering parameters `s_params`. The `z_params` input is a complex  $N$ -by- $N$ -by- $M$  array, representing  $M$   $N$ -port Z-parameters. `z0` is the reference impedance; its default is 50 ohms. `s_params` is a complex  $N$ -by- $N$ -by- $M$  array, representing  $M$   $n$ -port S-parameters.

**Alternatives** You can also use network parameter objects to perform network parameter conversions. For more information, see “RF Network Parameter Objects” on page 2-12.

**Examples** Convert Z-parameters to S-parameters:

```
%Define a matrix of Z-parameters.  
Z11 = -14567.2412789287 - 148373.315116592i  
Z12 = -14588.1106171651 - 148388.583516562i  
Z21 = -14528.0522132692 - 148350.705757767i  
Z22 = -14548.5996561832 - 148363.457002006i  
z_params = [Z11,Z12; Z21,Z22];  
%Convert to S-parameters  
s_params = z2s(z_params);
```

**See Also** `abcd2s` | `h2s` | `s2z` | `y2s` | `z2abcd` | `z2h` | `z2y`

---

<b>Purpose</b>	Convert Z-parameters to Y-parameters
<b>Syntax</b>	<code>y_params = z2y(z_params)</code>
<b>Description</b>	<code>y_params = z2y(z_params)</code> converts the impedance parameters <code>z_params</code> into the admittance parameters <code>y_params</code> . The <code>z_params</code> input is a complex N-by-N-by- <i>M</i> array, representing <i>M</i> N-port Z-parameters. <code>y_params</code> is a complex N-by-N-by- <i>M</i> array, representing <i>M</i> N-port Y-parameters.
<b>Examples</b>	Convert Z-parameters to Y-parameters:  <pre>%Define a matrix of Z-parameters. Z11 = -14567.2412789287 - 148373.315116592i Z12 = -14588.1106171651 - 148388.583516562i Z21 = -14528.0522132692 - 148350.705757767i Z22 = -14548.5996561832 - 148363.457002006i z_params = [Z11,Z12; Z21,Z22]; %Convert to Y-parameters y_params = z2y(z_params);</pre>
<b>See Also</b>	<code>abcd2y</code>   <code>h2y</code>   <code>s2y</code>   <code>y2z</code>   <code>z2abcd</code>   <code>z2h</code>   <code>z2s</code>

**z2y**

---

# AMP File Format

---

## AMP File Data Sections

In this section...
“Overview” on page A-2
“Denoting Comments” on page A-3
“Data Sections” on page A-3
“S, Y, or Z Network Parameters” on page A-4
“Noise Parameters” on page A-6
“Noise Figure Data” on page A-7
“Power Data” on page A-9
“IP3 Data” on page A-12
“Inconsistent Data Sections” on page A-13

### Overview

The AMP data file describes a single nonlinear device. Its format can contain the following types of data:

- S, Y, or Z network parameters
- Noise parameters
- Noise figure data
- Power data
- IP3 data

An AMP file must contain either power data or network parameter data to be valid. To accommodate analysis at more than one frequency, the file can contain more than one section of power data. Noise data, noise figure data, and IP3 data are optional.

---

**Note** If the file contains both network parameter data and power data, RF Toolbox software checks the data for consistency. If the amplifier gain computed from the network parameters is not consistent with the gain computed from the power data, a warning appears. For more information, see “Inconsistent Data Sections” on page A-13.

---

Two AMP files, `samplepa1.amp` and `default.amp`, ship with the toolbox to show the AMP format. They describe a nonlinear 2-port amplifier with noise. See “Model a Cascaded RF Network” on page 1-11 for an example that shows how to use an AMP file.

For information on specifying data in an AMP file, see “AMP File Data Sections” on page A-2. For information about adding comments to an AMP file, see “Denoting Comments” on page A-3.

## Denoting Comments

An asterisk (\*) or an exclamation point (!) precedes a comment that appears on a separate line.

A semicolon (;) precedes a comment that appears following data on the same line.

## Data Sections

Each kind of data resides in its own section. Each section consists of a two-line header followed by lines of numeric data. Numeric values can be in any valid MATLAB format.

A new header indicates the end of the previous section. The data sections can appear in any order in the file.

---

**Note** In the data section descriptions, brackets ([ ]) indicate optional data or characters. All values are case insensitive.

---

## S, Y, or Z Network Parameters

### Header Line 1

The first line of the header has the format

Keyword [Parameter] [R[REF][=]value]

Keyword indicates the type of network parameter. Its value can be S[PARAMETERS], Y[PARAMETERS], or Z[PARAMETERS]. Parameter indicates the form of the data. Its value can be MA, DB, or RI. The default for S-parameters is MA. The default for Y- and Z-parameters is RI. R[REF][=]value is the reference impedance. The default reference impedance is 50 ohms.

The following table explains the meaning of the allowable Parameter values.

Parameter	Description
MA	Data is given in (magnitude, angle) pairs with angle in degrees (default for S-parameters).
DB	Data is given in (dB-magnitude, angle) pairs with angle in degrees.
RI	Data is given in (real, imaginary) pairs (default for Y- and Z-parameters).

This example of a first line indicates that the section contains S-parameter data given in (real, imaginary) pairs, and that the reference impedance is 50 ohms.

S RI R 50

### Header Line 2

The second line of the header has the format

Independent\_variable Units

The data in a section is a function of the Independent\_variable. Currently, for S-, Y-, and Z-parameters, the value of Independent\_variable is always



F[FREQ]. Units indicates the default units of the frequency data. It can be GHz, MHz, or KHz. You must specify Units, but you can override this default on any given line of data.

This example of a second line indicates that the default units for frequency data is GHz.

```
FREQ GHZ
```

## Data

The data that follows the header typically consists of nine columns.

The first column contains the frequency points where network parameters are measured. They can appear in any order. If the frequency is given in units other than those you specified as the default, you must follow the value with the appropriate units; there should be no intervening spaces. For example,

```
FREQ GHZ
1000MHZ ...
2000MHZ ...
3000MHZ ...
```

Columns two through nine contain 2-port network parameters in the order N11, N21, N12, N22. Similar to the Touchstone format, each Nnn corresponds to two consecutive columns of data in the chosen form: MA, DB, or RI. The data can be in any valid MATLAB format.

This example is derived from the file `default.amp`. A comment line explains the column arrangement of the data where `re` indicates real and `im` indicates imaginary.

```
S RI R 50
FREQ GHZ
* FREQ      reS11      imS11      reS21      imS21      reS12      imS12      reS22      imS22
  1.00 -0.724725 -0.481324 -0.685727  1.782660  0.000000  0.000000 -0.074122 -0.321568
  1.01 -0.731774 -0.471453 -0.655990  1.798041  0.001399  0.000463 -0.076091 -0.319025
  1.02 -0.738760 -0.461585 -0.626185  1.813092  0.002733  0.000887 -0.077999 -0.316488
```

## Noise Parameters

### Header Line 1

The first line of the header has the format

Keyword

Keyword must be NOI[SE].

### Header Line 2

The second line of the header has the format

Variable Units

Variable must be F[FREQ]. Units indicates the default units of the frequency data. It can be GHZ, MHZ, or KHZ. You can override this default on any given line of data. This example of a second line indicates that frequency data is assumed to be in GHZ, unless other units are specified.

FREQ GHZ

### Data

The data that follows the header must consist of five columns.

The first column contains the frequency points at which noise parameters were measured. The frequency points can appear in any order. If the frequency is given in units other than those you specified as the default, you must follow the value with the appropriate units; there should be no intervening spaces. For example,

```
NOI
FREQ GHZ
1000MHZ ...
2000MHZ ...
3      ...
4      ...
5      ...
```

Columns two through five contain, in order,

- Minimum noise figure in decibels
- Magnitude of the source reflection coefficient to realize minimum noise figure
- Phase in degrees of the source reflection coefficient
- Effective noise resistance normalized to the reference impedance of the network parameters

This example is taken from the file `default.amp`. A comment line explains the column arrangement of the data.

```
NOI RN
FREQ GHz
* Freq Fmin(dB) GammaOpt(MA:Mag) GammaOpt(MA:Ang) RN/Zo
  1.90 10.200000 1.234000 -78.400000 0.240000
  1.93 12.300000 1.235000 -68.600000 0.340000
  2.06 13.100000 1.254000 -56.700000 0.440000
  2.08 13.500000 1.534000 -52.800000 0.540000
  2.10 13.900000 1.263000 -44.400000 0.640000
```

## Noise Figure Data

The AMP file format supports the use of frequency-dependent noise figure (NF) data.

### Header Line 1

The first line of the header has the format

```
Keyword [Units]
```

For noise figure data, `Keyword` must be `NF`. The optional `Units` field indicates the default units of the NF data. Its value must be `dB`, i.e., data must be given in decibels.

This example of a first line indicates that the section contains NF data, which is assumed to be in decibels.

NF

## Header Line 2

The second line of the header has the format

Variable Units

Variable must be F[REQ]. Units indicates the default units of the frequency data. It can be GHz, MHz, or KHz. This example of a second line indicates that frequency data is assumed to be in GHz.

FREQ GHz

## Data

The data that follows the header typically consists of two columns.

The first column contains the frequency points at which the NF data are measured. Frequency points can appear in any order. For example,

```
NF
FREQ MHz
2090 ...
2180 ...
2270 ...
```

Column two contains the corresponding NF data in decibels.

This example is derived from the file `samplepa1.amp`.

```
NF dB
FREQ GHz
1.900 10.3963213
2.000 12.8797965
2.100 14.0611765
2.200 13.2556751
2.300 12.9498642
2.400 13.3244309
```

2.500 12.7545104

---

**Note** If your noise figure data consists of a single scalar value with no associated frequency, that same value is used for all frequencies. Enter the value in column 1 of the line following header line 2. You must include the second line of the header, but it is ignored.

---

## Power Data

An AMP file describes power data as input power-dependent output power.

### Header Line 1

The first line of the header has the format

Keyword [Units]

For power data, **Keyword** must be POUT, indicating that this section contains power data. Because output power is complex, **Units** indicates the default units of the magnitude of the output power data. It can be dBW, dBm, mW, or W. The default is W. You can override this default on any given line of data.

The following table explains the meaning of the allowable **Units** values.

### Allowable Power Data Units

Units	Description
dBW	Decibels referenced to one watt
dBm	Decibels referenced to one milliwatt
mW	Milliwatts
W	Watts

This example of a first line indicates that the section contains output power data whose magnitude is assumed to be in decibels referenced to one milliwatt, unless other units are specified.

POUT dBm

## Header Line 2

The second line of the header has the format

Keyword [Units] FREQ[=]value

Keyword must be PIN. Units indicates the default units of the input power data. See Allowable Power Data Units on page A-9 for a complete list of valid values. The default is W. You can override this default on any given line of data. FREQ[=]value is the frequency point at which the power is measured. The units of the frequency point must be specified explicitly using the abbreviations GHz, MHz, kHz, or Hz.

This example of a second line indicates that the section contains input power data that is assumed to be in decibels referenced to one milliwatt, unless other units are specified. It also indicates that the power data was measured at a frequency of 2.1E+009 Hz.

PIN dBm FREQ=2.1E+009Hz

## Data

The data that follows the header typically consists of three columns:

- The first column contains input power data. The data can appear in any order.
- The second column contains the corresponding output power magnitude.
- The third column contains the output phase shift in degrees.

---

**Note** RF Toolbox software does not use the phase data directly. SimRF blocks use this data in conjunction with RF Toolbox software to create the AM/PM conversion table for the Equivalent Baseband library and blocks.

---

If all phases are zero, you can omit the third column. If all phases are zero or omitted, the toolbox assumes that the small signal phase from the network

parameter section of the file ( $180 \cdot \text{angle}(S_{21}(f)) / \pi$ ) is the phase for all power levels.

In contrast, if one or more phases in the power data section are nonzero, the toolbox interpolates and extrapolates the data to determine the phase at all power levels. The small signal phase ( $180 \cdot \text{angle}(S_{21}(f)) / \pi$ ) from the network parameter section is ignored.

Inconsistency between the power data and network parameter sections of the file may cause incorrect results. To avoid this outcome, verify that the following criteria must be met:

- The lowest input power value for which power data exists falls in the small signal (linear) region.
- In the power table for each frequency point  $f$ , the power gain and phase at the lowest input power value are equal to  $20 \cdot \log_{10}(\text{abs}(S_{21}(f)))$  and  $180 \cdot \text{angle}(S_{21}(f)) / \pi$ , respectively, in the network parameter section.

If the power is given in units other than those you specified as the default, you must follow the value with the appropriate units. There should be no intervening spaces.

This example is derived from the file `default.amp`. A comment line explains the column arrangement of the data.

```
POUT dbm
PIN dBm  FREQ = 2.10GHz
* Pin      Pout          Phase(degrees)
  0.0      19.28          0.0
  1.0      20.27          0.0
  2.0      21.26          0.0
```

---

**Note** The file can contain more than one section of power data, with each section corresponding to a different frequency value. When you analyze data from a file with multiple power data sections, power data is taken from the frequency point that is closest to the analysis frequency.

---

## **IP3 Data**

An AMP file can include frequency-dependent, third-order input (IIP3) or output (OIP3) intercept points.

### **Header Line 1**

The first line of the header has the format

```
Keyword [Units]
```

For IP3 data, `Keyword` can be either `IIP3` or `OIP3`, indicating that this section contains input IP3 data or output IP3 data. `Units` indicates the default units of the IP3 data. Valid values are `dBW`, `dBm`, `mW`, and `W`. The default is `W`. See Allowable Power Data Units on page A-9 for an explanation of the allowable `Units` values.

This example of a first line indicates that the section contains input IP3 data which is assumed to be in decibels referenced to one milliwatt.

```
IIP3 dBm
```

### **Header Line 2**

The second line of the header has the format

```
Variable Units
```

`Variable` must be `FREQ`. `Units` indicates the default units of the frequency data. Valid values are `GHZ`, `MHZ`, and `KHZ`. This example of a second line indicates that frequency data is assumed to be in `GHZ`.

```
FREQ GHZ
```

### **Data**

The data that follows the header typically consists of two columns.

The first column contains the frequency points at which the IP3 parameters are measured. Frequency points can appear in any order.



```
OIP3
FREQ GHz
2.010 ...
2.020 ...
2.030 ...
```

Column two contains the corresponding IP3 data.

This example is derived from the file `samplepa1.amp`.

```
OIP3 dBm
FREQ GHz
2.100 38.8730377
```

---

**Note** If your IP3 data consists of a single scalar value with no associated frequency, then that same value is used for all frequencies. Enter the value in column 1 of the line following header line 2. You must include the second line of the header, but the application ignores it.

---

## Inconsistent Data Sections

If an AMP file contains both network parameter data and power data, RF Toolbox software checks the data for consistency.

The toolbox compares the small-signal amplifier gain defined by the network parameters,  $S_{21}$ , and by the power data,  $P_{out} - P_{in}$ . The discrepancy between the two is computed in dBm using the following equation:

$$\Delta P = S_{21}(f_P) - P_{out}(f_P) + P_{in}(f_P)$$

where  $f_P$  is the lowest frequency for which power data is specified.

The discrepancy is shown in the following graph.

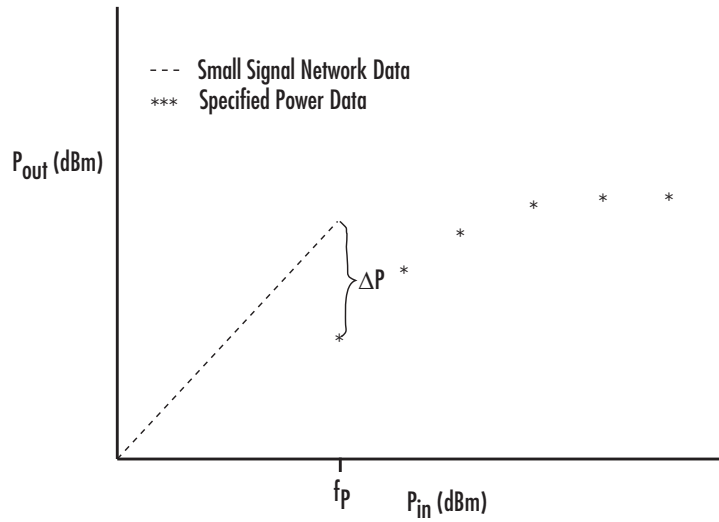

If  $\Delta P$  is more than 0.4 dB, a warning appears. Large discrepancies may indicate measurement errors that require resolution.

# Examples

---

Use this list to find examples in the documentation.

## **Modeling a Cascaded RF Network**

“Model a Cascaded RF Network” on page 1-11

## **Modeling a Transmission Line**

“Analyze a Transmission Line” on page 1-19

## **Working with Objects**

“Set Circuit Object Properties Using Data Objects” on page 3-11

“Read and Analyze RF Data from a Touchstone Data File” on page 3-41

“De-Embed S-Parameters” on page 3-43

## **Exporting Object Data**

“Export Object Data” on page 3-39

## **Modeling an RF Network Using RF Tool**

“Model an RF Network Using RF Tool” on page 5-31



## A

- ABCD-parameters
  - converting to h-parameters 11-2
  - converting to S-parameters 11-3
  - converting to Y-parameters 11-4
  - converting to Z-parameters 11-5
- abcd2h function 11-2
- abcd2s function 11-3
- abcd2y function 11-4
- abcd2z function 11-5
- accessing
  - object properties 3-14
- addMixer method 9-2
- AMP file format A-1
  - comments A-3
  - data sections A-2
  - noise parameters A-6
  - overview A-2
  - power data A-9
  - S, Y, Z Network Parameters A-4
- analysis
  - list of methods 8-2
- analyze method 9-4

## B

- budget plots 3-28

## C

- calculate method 9-8
  - example 9-11
- calculations
  - cascading S-parameters 11-6
  - circuit analysis 9-4
  - de-embedding S-parameters 11-13
  - input reflection coefficient 11-16
  - list of functions 10-2
  - load reflection coefficient 11-17
  - output reflection coefficient 11-19

- power gain 11-29
- source reflection coefficient 11-18
- specified network parameters 9-8
- cascadesparams function 11-6
- cascading
  - S-parameters 11-6
- chart properties 11-79
- circle method 9-13
- circuit 9-4
- circuit analysis
  - analyze method 9-4
- circuit object methods
  - list of 2-7
- circuit objects
  - constructing 3-2
  - copying 11-12
  - exporting to Verilog-A 4-5
  - list of 2-5
  - overview 2-4
- coaxial transmission line
  - shunt and series stubs 7-164
  - stubless 7-162
- constructing new objects 3-2
- conversion
  - 2N-port S-parameters to 4N-port S-parameters 11-85
  - 4N-port S-parameters to 2N-port S-parameters 11-65
  - ABCD-parameters to h-parameters 11-2
  - ABCD-parameters to S-parameters 11-3
  - ABCD-parameters to Y-parameters 11-4
  - ABCD-parameters to Z-parameters 11-5
  - g-parameters to h-parameters 11-14
  - h-parameters to ABCD-parameters 11-21
  - h-parameters to g-parameters 11-22
  - h-parameters to S-parameters 11-23
  - h-parameters to Y-parameters 11-24
  - h-parameters to Z-parameters 11-25
  - impedance to reflection coefficient 11-104

- N-port S-parameters to M-port
    - S-parameters 11-88
    - reflection coefficient to impedance 11-15
    - S-parameters to ABCD-parameters 11-45
    - S-parameters to h-parameters 11-46
    - S-parameters to S-parameters 11-51
    - S-parameters to T-parameters 11-70
    - S-parameters to transfer function 11-72
    - S-parameters to Y-parameters 11-77
    - S-parameters to Z-parameters 11-78
    - T-parameters to S-parameters 11-96
    - Y-parameters to ABCD-parameters 11-99
    - Y-parameters to h-parameters 11-100
    - Y-parameters to S-parameters 11-101
    - Y-parameters to Z-parameters 11-102
    - Z-parameters to ABCD-parameters 11-103
    - Z-parameters to h-parameters 11-105
    - Z-parameters to S-parameters 11-106
    - Z-parameters to Y-parameters 11-107
  - conversion functions
    - network parameters 10-5
  - coplanar waveguide transmission line
    - shunt and series stubs 7-178
    - stubless 7-177
  - copy function 11-12
  - copying objects 3-4
- D**
- data access and restoration
    - list of methods 8-8
  - data I/O
    - list of methods 8-7
    - updating data object from a file 9-56
    - writing a Verilog-A file from a model object 9-86
    - writing file from a data object 9-84
  - data object methods
    - list of 2-3
  - data objects
    - copying 11-12
    - corresponding to circuit object 11-20
    - list of 2-2
    - overview 2-2
  - data visualization
    - circles on Smith chart 9-13
    - list of functions 10-3
    - list of methods 8-3
    - log-log plot 9-29
    - plot with left and right y-axes 9-39
    - polar plane 9-52
    - semilogx plot 9-60
    - semilogy plot 9-64
    - Smith chart from complex vector 11-79
    - Smith chart from object 9-73
    - using RF Tool 5-20
    - X-Y plane 9-33
  - de-embedding
    - S-parameters 11-13
  - deembedsparams function 11-13
  - displaying operating conditions 9-18
  - draw circles on Smith chart 9-13
- E**
- exporting Verilog-A models 4-5
  - extract method 9-15
  - extracting
    - network parameters 9-15
- F**
- file formats A-1
    - AMP A-1
    - supported 3-8
    - writing 3-38
  - file I/O
    - updating data object from a file 9-56
    - writing a Verilog-A file from a model object 9-86

- writing file from a data object 9-84
- freqresp method 9-16
  - example 9-16

**G**

- g-parameters
  - converting to h-parameters 11-14
- g2h function 11-14
- gamma2z function 11-15
- gammain function 11-16
- gammaout function 11-17
- gammaout function 11-18
- gammaout function 11-19
- general transmission line
  - shunt and series stubs 7-361
  - stubless 7-360
- getdata function 11-20
- getop method 9-18
- getSpurData method 9-19
- getSpurFreeZoneData method 9-20
- getz0 method 9-21

**H**

- h-parameters
  - converting to ABCD-parameters 11-21
  - converting to g-parameters 11-22
  - converting to S-parameters 11-23
  - converting to Y-parameters 11-24
  - converting to Z-parameters 11-25
- h2abcd function 11-21
- h2g function 11-22
- h2s function 11-23
- h2y function 11-24
- h2z function 11-25

**I**

- impedance
  - converting to reflection coefficient 11-104

- impulse method 9-22
  - example 9-23
- input reflection coefficient
  - calculating 11-16
- ispassive function 11-26

**L**

- listformat method 9-25
  - example 9-25
- listparam method 9-27
  - example 9-28
- load reflection coefficient
  - calculating 11-17
- loglog method 9-29

**M**

- makepassive function 11-27
- methods
  - rfckt and rfdata objects 3-25
  - that act on objects 3-25
- microstrip transmission line
  - shunt and series stubs 7-256
  - stubless 7-255
- mixer spur plots 3-31
- model object methods
  - list of 2-10
- model objects
  - constructing 3-2
  - list of 2-10
  - overview 2-10
- models
  - exporting to Verilog-A 4-2
  - how to export Verilog-A 4-5

**N**

- network parameters
  - calculating 9-8
  - cascading 11-6

- conversion functions 10-5
- de-embedding 11-13
- extracting 9-15
- listing valid formats 9-25
- updating from a file 9-56
- valid for a circuit or data object 9-27
- visualization 8-3
- writing to a file 9-84

notation

- S-parameter 1-6

## O

objects

- analysis 9-4
- constructing new 3-2
- copying 3-4
- example using RF Tool 5-31
- example using rfckt objects 1-11
- example using rfmodel objects 1-19
- introduction to their use 1-4
- methods 3-25
- methods that act on 3-25
- properties 3-5

operating conditions

- displaying 9-18
- list of methods 8-6
- setting 9-68

output reflection coefficient

- calculating 11-19

## P

parallel-plate transmission line

- shunt and series stubs 7-291
- stubless 7-289

plot method 9-33

plot parameters and formats

- list of methods 8-5

plots

budget 3-28

draw circles on Smith chart 9-13

left and right y-axes 9-39

log-log 9-29

mixer spur 3-31

polar plane 9-52

rectangular 3-28

semilogx 9-60

semilogy 9-64

Smith chart from complex vector 11-79

Smith chart from object 9-73

- using RF Tool 5-20
- X-Y plane 9-33

plotyy method 9-39

polar method 9-52

powergain function 11-29

properties of objects 3-5

- retrieving 3-14
- setting 3-5

## R

rational function model

- writing to a Verilog-A file 9-86

rationalfit function 11-32

read method 9-56

reflection coefficient

- calculating input 11-16
- calculating load 11-17
- calculating output 11-19
- calculating source 11-18
- converting to impedance 11-15

report method 9-58 9-70

response

- frequency 9-16
- impulse 9-22
- time 9-82

restore method 9-59

retrieving

- object properties 3-14

- RF circuit object methods
  - list of 2-7
- RF circuit objects
  - constructing 3-2
  - list of 2-5
- RF data object methods
  - list of 2-3
- RF data objects
  - constructing 3-2
  - list of 2-2
- RF model object methods
  - list of 2-10
- RF model objects
  - constructing 3-2
  - list of 2-10
- RF objects
  - modeling using Verilog-A 4-2
- RF Tool
  - adding a component 5-8
  - adding a network 5-11
  - analyzing circuits 5-20
  - available components 5-7
  - available networks 5-11
  - creating components and networks 5-6
  - deleting circuits 5-27
  - exporting RF objects 5-23
  - exporting RF objects to MATLAB
    - workspace 5-23
  - exporting to file 5-25
  - importing from file to network 5-18
  - importing from file to session 5-16
  - importing RF objects 5-15
  - importing RF objects from MATLAB
    - workspace 5-16
  - modifying component parameters 5-19
  - naming sessions 5-28
  - opening existing sessions 5-30
  - opening the tool 5-2
  - overview of use 5-2
  - plotting network parameters 5-20
  - populating a network 5-13
  - reordering circuits 5-14
  - saving sessions 5-29
  - sessions 5-2
  - starting new sessions 5-30
  - window 5-3
  - workflow 5-5
  - working with circuits 5-27
  - working with sessions 5-28
- rfckt methods
  - analyze 9-4
  - calculate 9-8
  - circle 9-13
  - copy 11-12
  - getdata 11-20
  - listformat 9-25
  - listparam 9-27
  - loglog 9-29
  - plot 9-33
  - plotyy 9-39
  - polar 9-52
  - semilogx 9-60
  - semilogy 9-64
  - smith 9-73
- rfckt objects
  - changing properties 3-7
  - viewing properties 3-14
- rfdata methods
  - analyze 9-4
  - calculate 9-8
  - circle 9-13
  - copy 11-12
  - extract 9-15
  - listformat 9-25
  - listparam 9-27
  - loglog 9-29
  - plot 9-33
  - plotyy 9-39
  - polar 9-52
  - read 9-56



- two-wire 7-345
- stubs (shunt and series)
  - coaxial transmission line 7-164
  - coplanar waveguide transmission line 7-178
  - general transmission line 7-361
  - microstrip transmission line 7-256
  - parallel-plate transmission line 7-291
  - two-wire transmission line 7-347

**T**

- T-parameters
  - converting to S-parameters 11-96
- t2s function 11-96
- table method 9-81
- time response
  - computing 9-82
- timeresp method 9-82
  - example 9-82
- two-wire transmission line
  - shunt and series stubs 7-347
  - stubless 7-345

**U**

- utility functions
  - list of 10-4

**V**

- Verilog-A
  - how to export models 4-5
  - modeling RF objects using 4-2
  - overview 4-2
  - supported models 4-3
- visualization
  - circles on Smith chart 9-13
  - log-lot plot 9-29
  - plot with left and right y-axes 9-39
  - polar plane 9-52
  - semilogx plot 9-60

- semilogy plot 9-64
- Smith chart from complex vector 11-79
- Smith chart from object 9-73
  - using RF Tool 5-20
  - X-Y plane 9-33
- voltage standing-wave ratio (VSWR)
  - calculating 11-98
- VSWR
  - calculating 11-98
- vswr function 11-98

**W**

- write method 9-84
- writeva method 9-86

**Y**

- Y-parameters
  - converting to ABCD-parameters 11-99
  - converting to h-parameters 11-100
  - converting to S-parameters 11-101
  - converting to Z-parameters 11-102
- y2abcd function 11-99
- y2h function 11-100
- y2s function 11-101
- y2z function 11-102

**Z**

- Z-parameters
  - converting to ABCD-parameters 11-103
  - converting to h-parameters 11-105
  - converting to S-parameters 11-106
  - converting to Y-parameters 11-107
- z2abcd function 11-103
- z2gamma function 11-104
- z2h function 11-105
- z2s function 11-106
- z2y function 11-107